

TravelMate 4070/4080 Series

Service Guide

Service guide files and updates are available on the ACER/CSD web; for more information, please refer to <http://csd.acer.com.tw>

PRINTED IN TAIWAN

Revision History

Please refer to the table below for the updates made on TravelMate 4070/4080 service guide.

Date	Chapter	Updates

Copyright

Copyright © 2006 by Acer Incorporated. All rights reserved. No part of this publication may be reproduced, transmitted, transcribed, stored in a retrieval system, or translated into any language or computer language, in any form or by any means, electronic, mechanical, magnetic, optical, chemical, manual or otherwise, without the prior written permission of Acer Incorporated.

Disclaimer

The information in this guide is subject to change without notice.

Acer Incorporated makes no representations or warranties, either expressed or implied, with respect to the contents hereof and specifically disclaims any warranties of merchantability or fitness for any particular purpose. Any Acer Incorporated software described in this manual is sold or licensed "as is". Should the programs prove defective following their purchase, the buyer (and not Acer Incorporated, its distributor, or its dealer) assumes the entire cost of all necessary servicing, repair, and any incidental or consequential damages resulting from any defect in the software.

Acer is a registered trademark of Acer Corporation.

Intel is a registered trademark of Intel Corporation.

Pentium and Pentium II/III are trademarks of Intel Corporation.

Other brand and product names are trademarks and/or registered trademarks of their respective holders.

Conventions

The following conventions are used in this manual:

SCREEN MESSAGES	Denotes actual messages that appear on screen.
NOTE	Gives bits and pieces of additional information related to the current topic.
WARNING	Alerts you to any damage that might result from doing or not doing specific actions.
CAUTION	Gives precautionary measures to avoid possible hardware or software problems.
IMPORTANT	Reminds you to do specific actions relevant to the accomplishment of procedures.

Preface

Before using this information and the product it supports, please read the following general information.

1. This Service Guide provides you with all technical information relating to the BASIC CONFIGURATION decided for Acer's "global" product offering. To better fit local market requirements and enhance product competitiveness, your regional office MAY have decided to extend the functionality of a machine (e.g. add-on card, modem, or extra memory capability). These LOCALIZED FEATURES will NOT be covered in this generic service guide. In such cases, please contact your regional offices or the responsible personnel/channel to provide you with further technical details.
2. Please note WHEN ORDERING FRU PARTS, that you should check the most up-to-date information available on your regional web or channel. If, for whatever reason, a part number change is made, it will not be noted in the printed Service Guide. For ACER-AUTHORIZED SERVICE PROVIDERS, your Acer office may have a DIFFERENT part number code to those given in the FRU list of this printed Service Guide. You MUST use the list provided by your regional Acer office to order FRU parts for repair and service of customer machines.

System Introduction

Features

This computer was designed with the user in mind. Here are just a few of its many features:

Platform

- Intel® Centrino® mobile technology, featuring:
 - Intel® Pentium® M 725A/735A/740/750/760/770/780 processor (2MB L2 cache, 1.60/1.70/1.73/1.86/2.0/2.13/2.26 GHz, 400/533 MHz FSB)
 - Intel® 915GM/915PM Express chipsets
 - Intel® PRO/Wireless 2200BG network connection (dual-mode 802.11b/g) Wi-Fi CERTIFIED™ solution, supporting Acer SignalUp™ wireless technology
- Intel® Celeron M processor 370/380/390 (1 MB L2 cache, 1.50/1.60/1.70 GHz, 400 MHz FSB)

Memory

- 256 MB/512 MB of DDRII 533 memory, upgradeable to 2 GB using two soDIMM modules

Data storage

- 40/60/80/100/120 GB ATA/100 hard disk
- DVD-Dual double-layer drive
- DVD/CD-RW combo drive
- DVD Super Multi double-layer

Display and graphics

- Color Thin-Film Transistor (TFT) LCD displaying at
 - 15" XGA (1024 X 768)
 - 15.4" WXGA (1280 X 800) supporting simultaneous multi-window viewing on dual displays via Acer GridVista™
- Intel® 915GM integrated 3D graphics, featuring Intel® Graphics Media Accelerator 950 and up to 128 MB of shared memory, supporting Microsoft® DirectX® 9.0 and dual independent display
- Intel® 915PM with ATI Mobility™ Radeon® X1300 HyperMemory™ 256/512MB, supporting ATI PowerPlay™ 5.0 Microsoft® DirectX® 9.0, DualView™
- MPEG-2/DVD hardware-assisted capability
- Simultaneous LCD and CRT display with LCD panel resolution at 70 Hz

Communication

- Modem: 56K ITU V.92 modem with PTT approval; Wake-on-Ring ready
- LAN: PCI/PCI Express® gigabit Ethernet; Wake-on-LAN ready
- Wireless LAN: integrated miniPCI Acer InviLink™ 802.11b/g Wi-Fi CERTIFIED™ solution; supporting Acer SignalUP™ wireless technology
- Wireless PAN: integrated Bluetooth®

Audio

- Audio system with two built-in speakers
- Intel® High-Definition audio support
- Sound Blaster Pro™ and MS-Sound compatible
- S/PDIF2 (Sony/Philips Digital Interface) support for digital speakers
- Built-in microphone

Input devices

- 88-/89-key Acer FineTouch™ keyboard
- Touchpad with 4-way integrated scroll button
- Four easy-launch buttons
- Two front-panel buttons: wireless LED-button and Bluetooth® LED-button

I/O interface

- Three USB 2.0 ports
- PC Card slot (one Type II)
- External display (VGA) port
- Microphone-in jack
- Headphone/speaker/line-out jack
- Ethernet (RJ-45) port
- Modem (RJ-11) port
- DC-in jack for AC adaptor

Environment

- Temperature:
 - Operating: 5° C to 35° C; Non-operating: -20° C to 65° C
- Humidity (non-condensation):
 - Operating: 20% to 80%; Non-operating: 20% to 80%

System Block Diagram

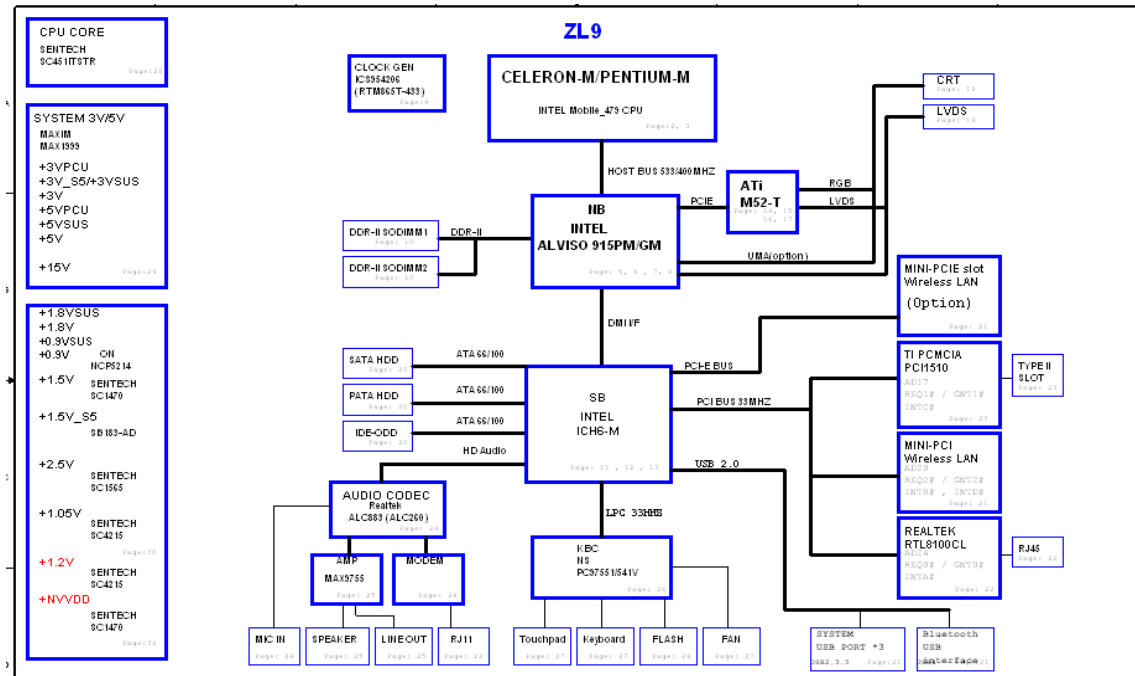

Board Layout

Top View

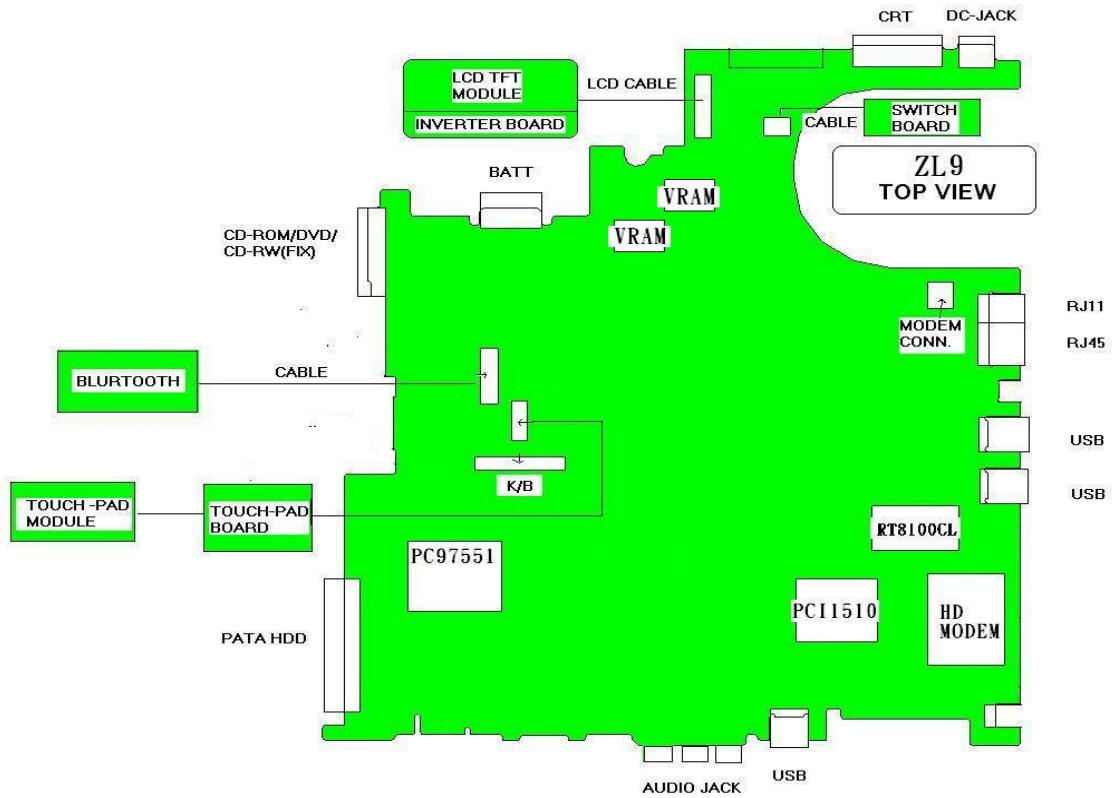

Bottom View

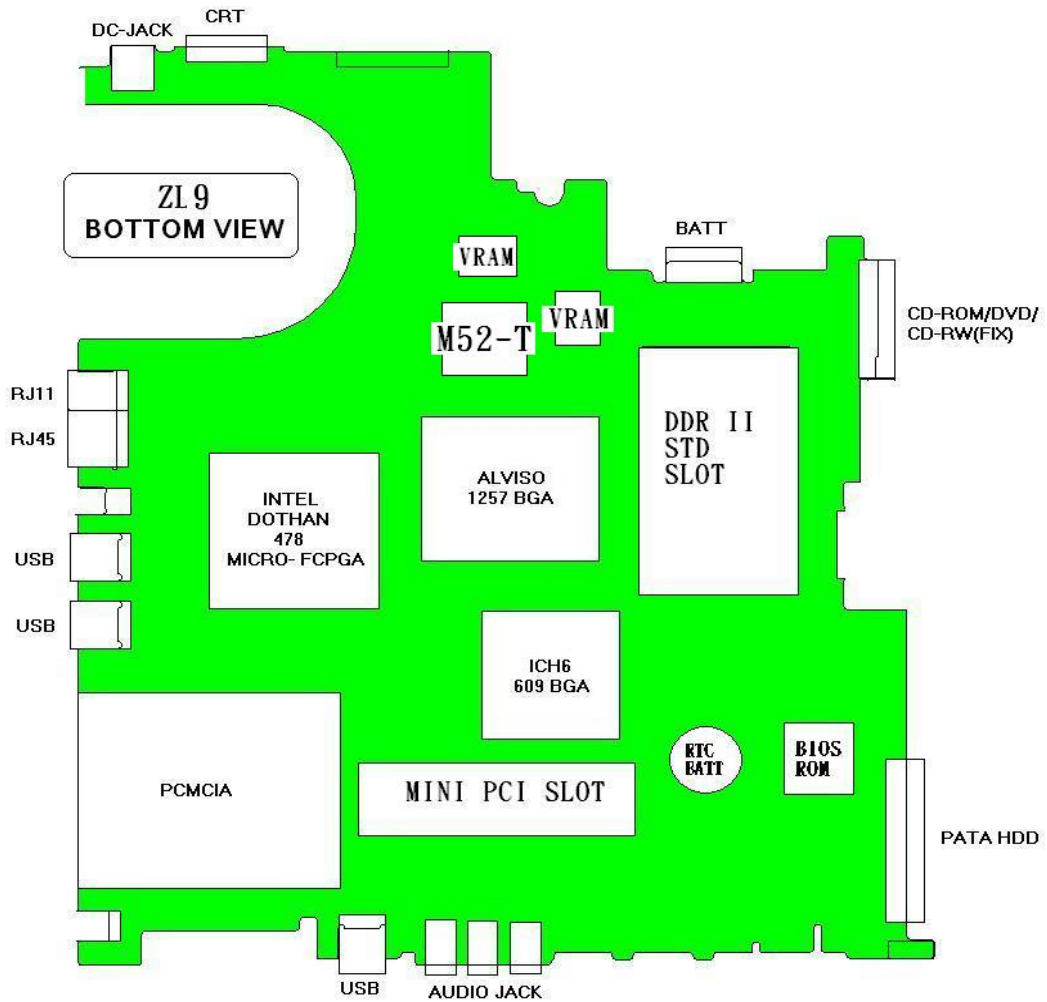

1	SW1	Lid Switch	2	CN1	LCD Connector
3	CN2	Launch Board Connector	4	CN3	Modem Connector
5	CN7	Keyboard Connector	6	CN4	Bluetooth Module Connector
7	CN5	Touchpad Board Connector	8	CN6	Internal Microphone Connector
9	U17	Clock Generator	10	U4	PCMCIA Connector
11	CN9	MDC Connector	12	CN11	Internal Speaker Connector
13	CN13	Power Jack	14	CN12	CRT Connector
15	CN14	Battery Connector	16	CN15	Optical Disk Drive Connector
17	CN17	RJ45 & RJ11 Connector	18	CN26	Wireless LAN Controller
19	U11	North Bridge	20	U13	CPU Socket
21	CN20	USB Connector	22	CN21	USB Connector
23	U19	BIOS ROM	24	U4	EC PC97551 (Power and I/O Connector)
25	CN22	RTC Battery	26	CN18	Memory Socket 1
27	U1	LAN Chipset RTL8100CL	28	CN19	Memory Socket 2

29	U18	South Bridge	30	CN24	PCMCIA Connector
31	CN25	HDD Connector	32	CN27	USB Connector
33	CN28	Line-out/SPEDIF Jack	34	CN29	Microphone Jack
35	CN30	Line-in Jack	36	SW3	WLAN Button
37	SW2	Bluetooth Button	38	LED2	Charger LED
39	LED1	Power LED	40	U22	Audio Codec
41	U10	Fan Connector			

Panel

This is a brief introduction to the I/O ports, the features and the indicators.









Front view



#	Item	Description
1	Display screen	Also called LCD (Liquid Crystal Display), displays computer output.
2	Microphone	Internal microphone for sound recording.
3	Keyboard	For entering data into you computer.
4	Palmrest	Comfortable support area for your hands when you use the computer.
5	Click buttons (Left, center and right)	The left and right buttons function like the left and right mouse buttons; the center button serves as a 4-way scroll button.
6	Touchpad	Touch-sensitive pointing device which functions like a computer mouse.
7	Status indicators	LEDs (Light Emitting Diodes) that turn on and off to show the status of the computer and its functions and components.
8	Easy-Launch buttons	Buttons for launching frequently used programs.
9	Power button	Turns the computer on and off.

Closed front view



#	Icon	Item/ Port	Description
1		Speakers	Left and right speakers deliver stereo audio output.
2		Power indicator	Lights up when the computer is on.
3		Battery indicator	Lights up when the battery is being charged.
4		Bluetooth communication button/ indicator	Press to enable/disable the Bluetooth function. Indicates the status of Bluetooth communication (optional).
5		Wireless communication button/ indicator	Press to enable/disable the wireless function. Indicates the status of wireless LAN communication (optional).
6		Line-in jack	Accepts audio line-in devices (e.g., audio CD player, stereo walkman).
7		Microphone jack	Accepts inputs from external microphones.
8		Speaker/Line-Out/Headphone jack	Connects to audio line-out devices (e.g., speakers, headphones).
9		USB 2.0 port	Connects to Universal Serial Bus (USB) 2.0 devices (e.g., USB mouse, UsB camera).





Left view

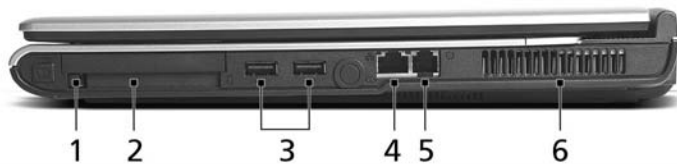

#	Icon	Item/ Port	Description
1		Optical drive	Internal optical drive; accepts CDs or DVDs depending on the optical drive type.
2		LED indicator	Lights up when the optical drive is active.
3		Optical drive eject button	Ejects the optical drive tray from the drive.
4		Emergency eject hole	Ejects the optical drive tray when the computer is turned off.



Right view



#	Icon	Item/ Port	Description
1		PC Card slot eject button	Ejects the PC Card from the slot
2		PC card slot	Accepts one Type II CardBus PC Card.
3		Two USB 2.0 ports	Connects to Universal Serial Bus (USB) 2.0 devices (e.g., USB mouse, USB camera).
4		Network jack	Connects to an Ethernet 10/100 based network.
5		Modem jack	Connects to a phone line.
6		Ventilation slots	Enable the computer to stay cool, even after prolonged use.

Rear view



#	Icon	Port	Description
1		Power jack	Connects to an AC adaptor.
2		External display port	Connects to a display device (e.g., external monitor, LCD projector).
3		Security keylock	Connects to a Kensington-compatible computer security lock.

Bottom view

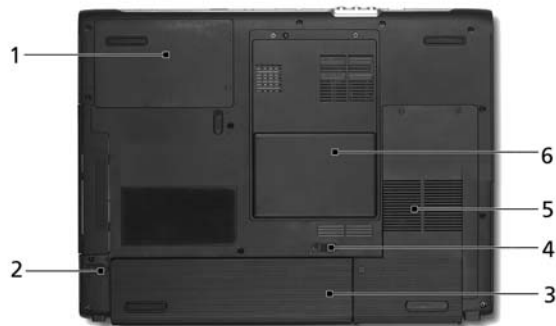

#	Item	Description
1	Hard disc bay	Houses the computer's hard disc (secured by a screw).
2	Battery release latch	Unlatches the battery to remove the battery pack.
3	Battery bay	Houses the computer's battery pack.
4	Battery lock	Locks the battery in place.
5	Cooling fan	Helps keep the computer cool. Note: Do not cover or obstruct the opening of the fan.
6	Memory compartment	House the computer's main memory.

Indicators

The computer has three easy-to-read status icons on the upper-right above the keyboard, and four on the front panel.



Icon	Function	Description
	Caps Lock	Lights when Caps Lock is activated.
	Num Lock	Lights when Numeric Lock is activated.
	Media activity	Indicates when the hard disk or optical drive is active.
	Power	Lights when the computer is on.
	Battery	Lights when the battery is being charged.
	Bluetooth	Indicates the status of Bluetooth communication.
	Wireless LAN	Indicates the status of Bluetooth communication.

NOTE: 1. Charging: the light shows amber when the battery is charging.

NOTE: 2. Fully charged: light shows green when in AC mode.

Easy-Launch Buttons

Located at the upper-right, above the keyboard are four buttons. These buttons are called launch keys. They are mail, Web browser, Acer Empowering key “*e*”, and one user-programmable button.

Press “*e*” to run the Acer eManager. The mail and Web buttons are pre-set to email and internet programs, but can be reset by users. To set the Web browser, mail and programmable keys, run the Acer Launch Manager.



Launch key	Default application
P	User-programmable
<i>e</i>	Acer eManager (user-programmable)
Web browser	Internet browser (user-programmable)
Mail	Email application (user-programmable)







Using the keyboard

The keyboard has full-sized keys and an embedded keypad, separate cursor keys, two Windows keys and twelve function keys.

Lock keys and embedded numeric keypad

The keyboard has three lock keys which you can toggle on and off.











Lock key	Description
Caps Lock 	When  is on, all alphabetic characters typed are in uppercase.
Num Lock <Fn>+<F11> 	When  is on, the embedded keypad is in numeric mode. The keys function as a calculator (complete with the arithmetic operators), -, *, and /). Use this mode when you need to do a lot of numeric data entry. A better solution would be to connect an external keypad.
Scroll Lock <Fn>+<F12> 	When  is on, the screen moves one line up or down when you press the up or down arrow keys respectively.  does not work with some applications.

The embedded numeric keypad functions like a desktop numeric keypad. It is indicated by small characters located on the upper right corner of the keycaps. To simplify the keyboard legend, cursor-control key symbols are not printed on the keys.

Desired access	Num lock on	Num lock off
Number keys on embedded keypad	Type numbers in a normal manner.	
Cursor-control keys on embedded keypad	Hold <Shift> while using cursor-control keys.	Hold <Fn> while using cursor-control keys.
Main keyboard keys	Hold <Fn> while typing letters on embedded keypad.	Type the letters in a normal manner.

Windows keys

The keyboard has two keys that perform Windows-specific functions.



Keys	Description
Windows logo key 	Start button. Combinations with this key perform shortcut functions. Below are a few examples:  + <Tab> (Activates the next Taskbar button)  + <E> (Opens the My Computer window)  + <F1> (Opens Help and Support)  + <F> (Opens the Find: All Files dialog box)  + <R> (Opens the Run dialog box)  + <M> (Minimizes all windows) <shift>+  + < M> (Undoes the minimize all windows)
Application key 	This key has the same effect as clicking the right mouse button; it opens the application's context menu.











Hot Keys

The computer employs hot keys or key combinations to access most of the computer's controls like screen contrast and brightness, volume output and the BIOS Utility.

To activate hot keys, press and hold the <Fn> key before pressing the other key in the hot key combination.



Hot Key	Icon	Function	Description
Fn- 	?	Hotkey help	Displays a list of the hotkeys and their functions.
Fn- 		Acer eSetting	Launches Acer eSetting in the eManager set by the Acer Empowering key..

Hot Key	Icon	Function	Description
Fn-F3		Power Management	Launches Power options.
Fn-F4		Sleep	Puts the computer in Sleep mode.
Fn-F5		Display toggle	Switches display output between the display screen, external monitor (if connected) and both the display screen and external monitor.
Fn-F6		Screen blank	Turns the display screen backlight off to save power. Press any key to return.
Fn-F7		Touchpad Toggle	Turns the internal touchpad on and off.
Fn-F8		Speaker toggle	Turns the speakers on and off.
Fn-↑		Volume up	Increases the sound volume.
Fn-↓		Volume down	Decreases the sound volume.
Fn-→		Brightness up	Increases the screen brightness.
Fn-←		Brightness down	Decreases the screen brightness.

Special keys

You can locate the Euro symbol at the upper-center (for European keyboard) and/or bottom-right (Chinese keyboard) of your keyboard. To type:

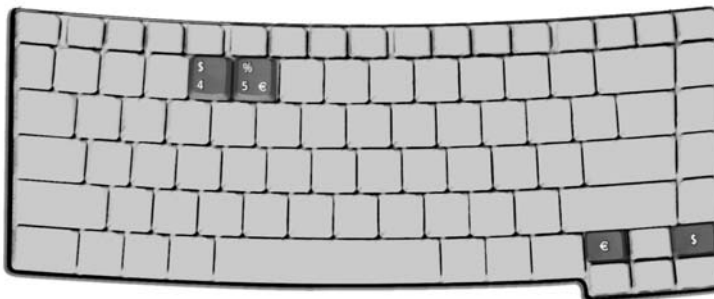

The Euro symbol

1. Open a text editor or word processor.
2. Either directly press the <Euro> key at the bottom-right of the keyboard (for Chinese keyboard), or hold <Alt Gr> and then press the <5> key at the upper-center of the keyboard.symbol at the upper-center of the keyboard (for European keyboard, you can use both method).

NOTE: Some fonts and software do not support the Euro symbol. Please refer to www.microsoft.com/typography/faq/faq12.htm for more information.

The US dollar sign

1. Open a text editor or word processor.
2. Either directly press the <Euro> key at the bottom-right of the keyboard (for Chinese keyboard), or hold <Shift> and then press the <4> key at the upper-center of the keyboard.symbol at the upper-center of the keyboard (for European keyboard, you can use both method).

NOTE: This function varies according to the language settings.

Touchpad

The built-in touchpad is a pointing device that senses movement on its surface. This means the cursor responds as you move your finger on the surface of the touchpad. The central location on the palmrest provides optimum comfort and support.

Touchpad basics

The following items teach you how to use the touchpad:



- * Move your finger across the touchpad (2) to move the cursor.
- * Press the left (1) and right (4) buttons located on the edge of the touchpad to do selection and execution functions. These two buttons are similar to the left and right buttons on a mouse. Tapping on the touchpad is the same as clicking the left button.
- * Use the 4-way scroll (3) button to scroll up or down and move left or right a page. This button mimics your cursor pressing on the right scroll bar of Windows applications.

Function	Left button (1)	Right button (4)	Touchpad (2)	Center button (3)
Execute	Click twice quickly.		Tap twice (at the same speed as double-clicking a mouse button).	
Select	Click once.		Tap once.	
Drag	Click and hold, then use finger to drag the cursor on the touchpad.		Tap twice (at the same speed as double-clicking a mouse button); hold finger to the touchpad on the second tap and drag the cursor.	
Access context menu		Click once.		
Scroll				Click and hold to move up/down/left/right.

NOTE: Keep your fingers dry and clean when using the touchpad. Also keep the touchpad dry and clean. The touchpad is sensitive to finger movement, hence, the lighter the touch, the better the response. Taping harder will not increase the touchpad's responsiveness.

Acer Empowering Technology

Acer's innovative Empowering Technology makes it easy for you to access frequently used functions and manage your new Acer notebook. It features the following handy utilities:

- Acer eDataSecurity Management** protects data with passwords and advanced encryption algorithms.
- Acer eLock Management** limits access to external storage media.
- Acer ePerformance Management** improves system performance by optimizing disk space, memory and registry settings.
- Acer eRecovery Management** backs up/recovers data flexibly, reliably and completely.
- Acer eSettings Management** accesses system information and adjusts settings easily.
- Acer eNet Management** hooks up to location-based networks intelligently.
- Acer ePower Management** extends battery power via versatile usage profiles.
- Acer ePresentation Management** connects to a projector and adjusts display settings conveniently.



For more information, press the < *e* > key to launch the Empowering Technology menu, then click on the appropriate utility and select the Help function.

Acer eDataSecurity Management

Acer eDataSecurity Management is handy file encryption utility that protects your files from being accessed by unauthorized persons. It is conveniently integrated with Windows explorer as a shell extension for quick and

easy data encryption/decryption and also supports on-the-fly file encryption for MSN Messenger and Microsoft Outlook.

There are two passwords that can be used to encrypt/decrypt a file; the supervisor password and the file-specific password. The supervisor password is a “master” password that can decrypt any file on your system; the file-specific password will be used to encrypt files by default, or you can choose to enter your own file-specific password when encrypting a file.

NOTE: The password used to encrypt a file is the unique key that the system needs to decrypt it. If you lose the password, the supervisor password is the only other key capable of decrypting the file. If you lose both passwords, there will be no way to decrypt your encrypted file! **Be sure to safeguard all related passwords!**



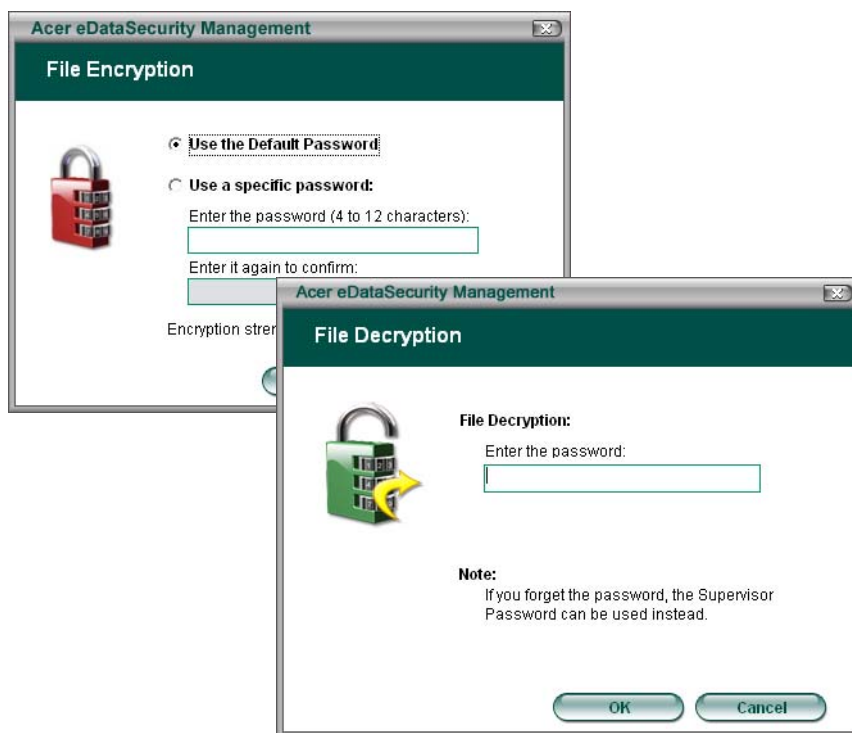

Acer eLock Management

Acer eLock Management is a security utility that allows you to lock up your removable data, optical and floppy drives to ensure that data can't be stolen while your notebook is unattended.

- Removable data devices - includes USB disk drives, USB pen drives, USB flash drives, USB MP3 drives, USB memory card readers, IEEE 1394 disk drives and any other removable disk drives that can be mounted as a file system when plugged into the system.
- Optical drive devices - includes any kind of CD-ROM or DVD-ROM drives.
- Floppy disk drives - 3.5-inch disks only.

To activate Acer eLock Management, a password must be set first. Once set, you may apply lock to any of the three kinds of devices. Lock(s) will immediately be set without any reboot necessary, and will remain locked after rebooting, until unlocked.

If you do not set a password, Acer eLock Management will reset back to the initial status with all locks removed.

NOTE: If you lose your password, there is no method to reset it except by reformatting your notebook or taking your notebook to an Acer Customer Service Center. Be sure to remember or write down your password.

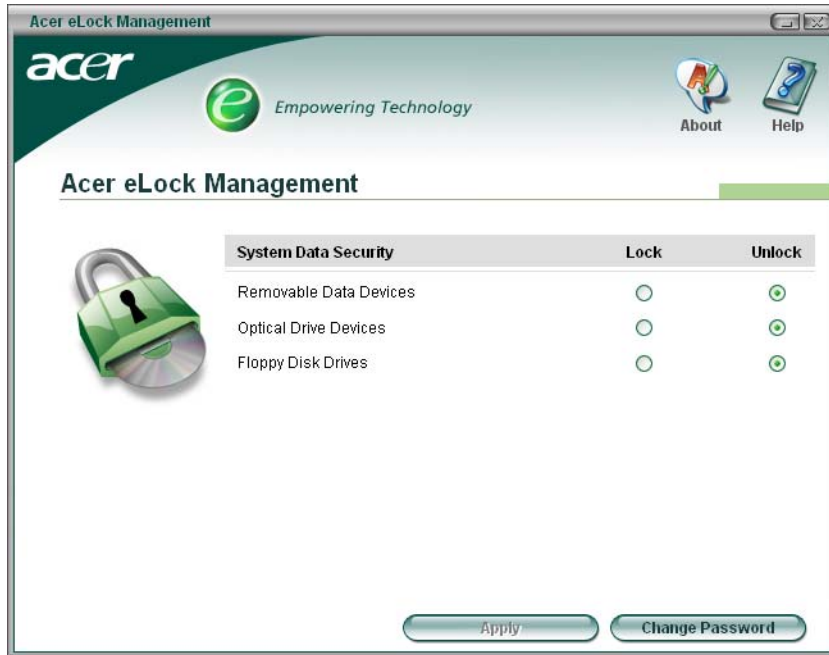

Acer ePerformance Management

Acer ePerformance Management is a system optimization tool that boosts the performance of your Acer notebook. It provides you with the following options to enhance overall system performance:

- Memory optimization - releases unused memory and check usage.
- Disk optimization - removes unneeded items and files.
- Speed optimization - improves the usability and performance of your Windows XP system.



Acer eRecovery Management

Acer eRecovery Management is a powerful utility that does away with the need for recovery disks provided by the manufacturer. The Acer eRecovery Management utility occupies space in a hidden partition on your system's HDD. User-created backups are stored on D:\ drive. Acer eRecovery Management provides you with:

- Password protection.
- Recovery of applications and drivers.
- Image/data backup:
 - Back up to HDD (set recovery point).
 - Back up to CD/DVD.
- Image/data recovery tools:
 - Recover from a hidden partition (factory defaults).
 - Recover from the HDD (most recent user-defined recovery point).
 - Recover from CD/DVD.



NOTE: If your computer did not come with a Recovery CD or System CD, please use Acer eRecovery Management's "System backup to optical disk" feature to burn a backup image to CD or DVD. To ensure the best results when recovering your system using a CD or Acer eRecovery Management, detach all peripherals (except the external Acer ODD, if your computer has one), including your Acer ezDock.

Acer eSettings Management

Acer eSettings Management allows you to inspect hardware specifications and to monitor the system health status. Furthermore, Acer eSettings Management enables you to optimize your Windows operating system, so your computer runs faster, smoother and better.

Acer eSettings Management also:

- Provides a simple graphical user interface for navigating through the program effortlessly.
- Displays general system status and advanced monitoring for power users.
- Logs when a hardware component has been removed or replaced.
- Permits you to migrate personal settings.
- Keeps a history log of all alerts that were previously issued.



Acer eNet Management

Acer eNet Management helps you to quickly and easily connect to both wired and wireless networks in a variety of locations. To access this utility, either click on the “Acer eNet Management” icon on your netebook, or start the program from the Start menu. You also have the option to set Acer eNet Management to start automatically when you boot up your PC.

Acer eNet Management automatically detects the best settings for a new location, while offering you the freedom to manually adjust the settings to match your needs, simply by right-clicking on the icon in the taskbar.

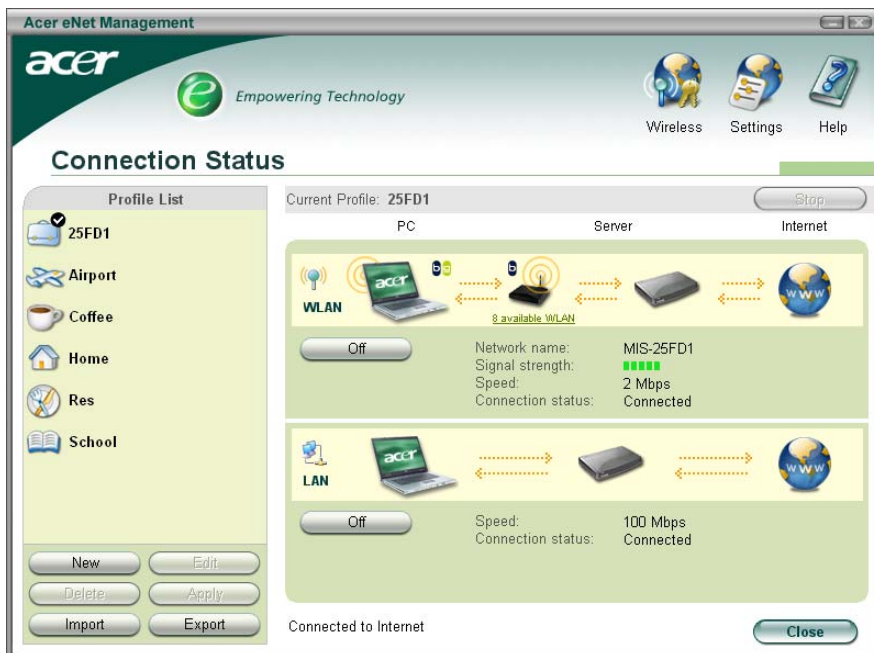

Acer eNet Management can save network settings for a location to a profile, and automatically apply the appropriate profile when you move from one location to another. Settings stored include network connection settings (IP and DNS settings, wireless AP details, etc.), as well as default printer settings.

Security and safety concerns mean that Acer eNet Management does not store username and password information.

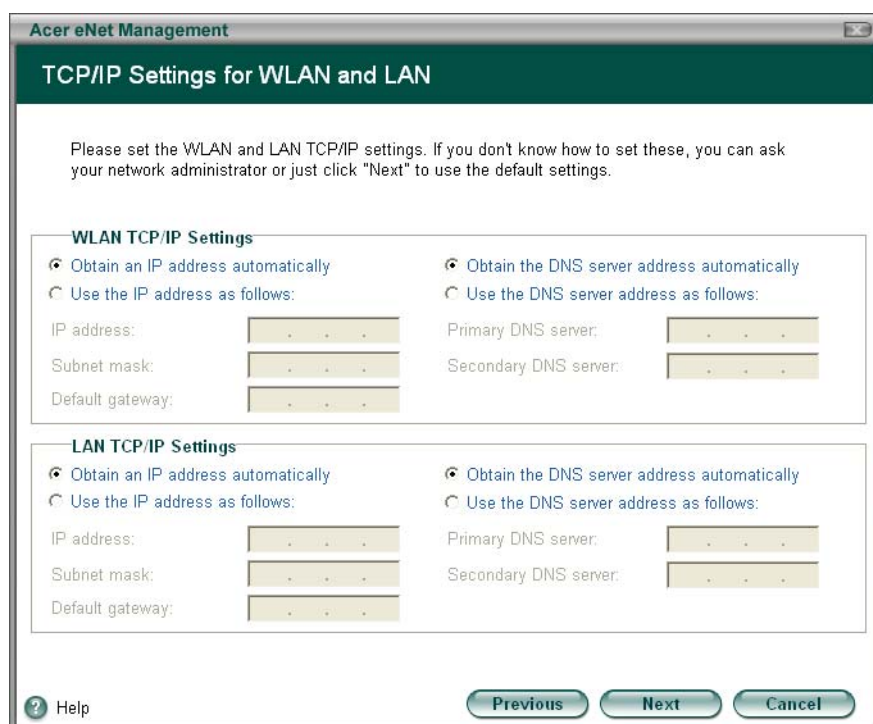

Acer ePower Management

Acer ePower Management features a straightforward user interface. To launch it, select Acer ePower Management from the Empowering Technology interface, or double-click the Acer ePower Management icon in the task tray.

Acer Mode

The default setting is "Maximum Performance." You can adjust CPU speed, LCD brightness and other settings, or click on buttons to turn the following functions on/off: Wireless LAN, Bluetooth, CardBus, Memory Card, Audio, and Wired LAN.

DC Mode

To suit your usage, there are four pre-defined profiles - Entertainment, Presentation, Word Processing, and Maximum Battery. Or, you can define up to three of your own profiles.

Create new power scheme

1. Assign a name for the new scheme.
2. Choose existing scheme to use as a template.
3. Select whether used for mains (AC) or battery mode.
4. Choose which power options best fit your needs, then click OK.
5. The new profile will appear on the main screen.

Battery status

For real-time battery life estimates based on current usage, refer to the panel on the lower left-hand side of the window.

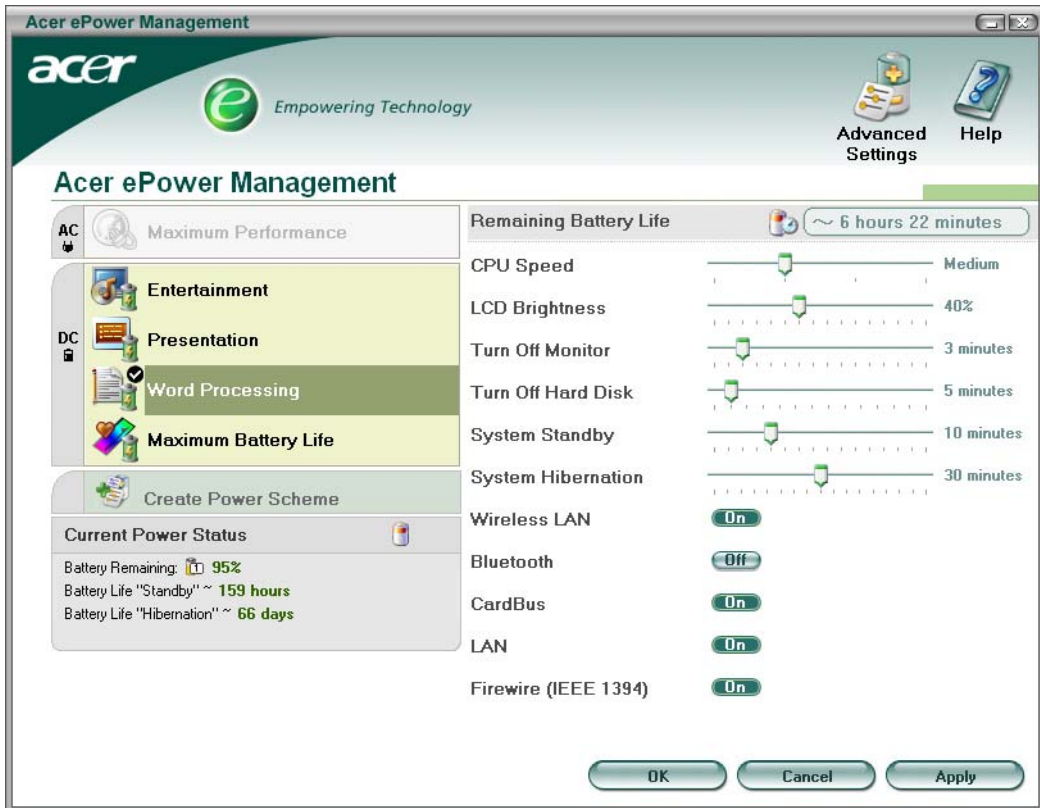

You can also click “Advanced Settings” to:

- Set alarms.
- Re-load factory defaults.
- Select what actions will be taken when the cover is closed, and set passwords for accessing the system after Hibernation or Standby.
- View information about Acer ePower Management.

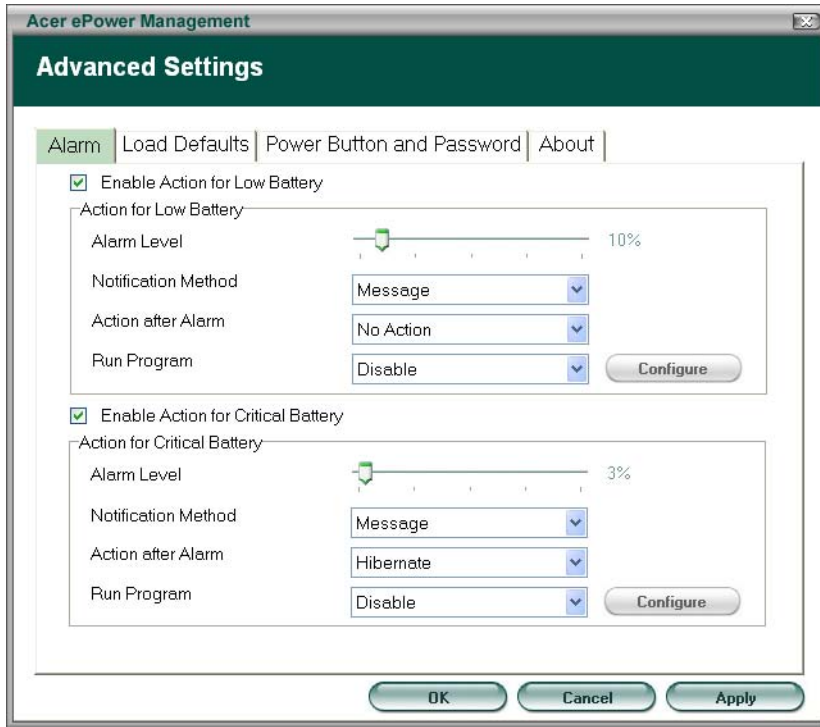

Acer ePresentation Management

Acer ePresentation Management lets you select from two of the most common projector resolutions: XGA and SVGA.

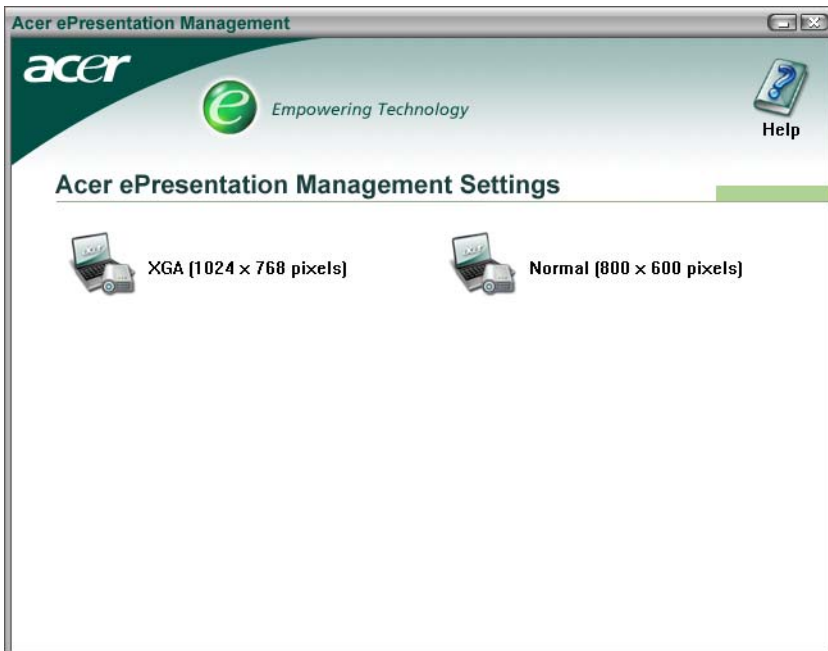

Hardware Specifications and Configurations

System Board Major Chip

Item	Controller
System core logic	Intel® 915GM/915PM Express chipsets+ICH6-M
Memory controller	Integrated in Intel® 915GM
Audio controller	RealTek ALC833(ALC260) HD audio interface (Audio amplifier: Maxiam MAX9755)
PCMCIA controller for socket	TI PCI1510A
Video controller	Integrated in Intel® 915GM for UMA models ATI X1300 RADEON® for discrete models
Power and Keyboard controller	KBC NS97551/541V
Wireless controller (mini PCI)	Intel (The controller is on the Wireless LAN card. Please look at the wireless LAN card for controller details).

Processor

Item	Specification
CPU type	Intel® Pentium® M 730/740/750/760/770/780 processor (2MB L2 cache, 1.60/1.73/1.86/2/2.13/2.26 GHz, 533 MHz FSB) Intel® Pentium® M 725 processor (2MB L2 Cache, 1.60 GHz, 400 MHz FSB) Intel® Celeron® M processor 360/370/380 (1 MB L2 cache, 1.40/1.50/1.60 GHz, 400 MHz FSB)
CPU package	Intel socketable 478 pins Micro-FCPGA
CPU core voltage	Low speed: 0.8V High speed: 1.5V
CPU I/O voltage	1.2V

BIOS

Item	Specification
BIOS vendor	Pheonix BIOS
BIOS Version	
BIOS ROM type	Flash ROM, SST39VF040
BIOS ROM size	512Kbyte
BIOS package	32 Pin PLCC-lead
Supported protocols	ACPI 2.0 (if available, at least 1.0b), SMBIOS 2.3, PCI 2.2, Boot Block, PXE 2.0, Mobile PC2001, Hard Disk Password, INT 13h Extensions, PCI Bus Power Management interface Specification, El Torito-Bootable CD-ROM Format Specification V1.0, Simple Boot Flag 1.0

Second Level Cache

Item	Specification
Cache controller	Built-in CPU
Cache size	2MB for Intel® Pentium® M processor 1MB for Intel® Celeron® M processor
1st level cache control	Always Enabled

Second Level Cache

Item	Specification
2nd level cache control	Always Enabled
Cache scheme control	Fixed-in write back

System Memory

Item	Specification
Memory controller	built-in CPU
Onboard memory size	0MB
DIMM socket number	2 Sockets
Supports memory size per socket	256MB(min)/1024MB(max)
Supports maximum memory size	2GB with 2 SODIMM support
Supports DIMM type	DDRII
Supports DIMM Speed	533MHz
Supports DIMM voltage	1.8 V/0.9V
Supports DIMM package	200-pin so-DIMM
Memory module combinations	You can install memory modules in any combinations as long as they match the above specifications .

Memory Combinations

Slot 1	Slot 2	Total Memory
0MB	256MB	256MB
0MB	512MB	512MB
0MB	1024MB	1024MB
256MB	0MB	256MB
256MB	256MB	512MB
256MB	512MB	768MB
256MB	1024MB	1280MB
512MB	0MB	512MB
512MB	256MB	768MB
512MB	512MB	1024MB
512MB	1024MB	1536MB
1024MB	0MB	1024MB
1024MB	256MB	1280MB
1024MB	512MB	1536MB
1024MB	1024MB	2048MB (2G)

Above table lists some system memory configurations. You may combine DIMMs with various capacities to form other combinations.

LAN Interface

Item	Specification
Chipset	RealTek 8100CL
Supports LAN protocol	10/100
LAN connector type	RJ45
LAN connector location	Right side

Modem Interface

Item	Specification
Chipset	CS1037 Internal Agere Scorpio chipset (Scorpio+CSP1037B)
Fax modem data baud rate (bps)	14.4K
Data modem data baud rate (bps)	56K
Supports modem protocol	V.92MDC
Modem connector type	RJ11
Modem connector location	Right side

Wireless Module 802.11b/g (optional device)

Item	Specification
Chipset	
Data throughput	11M~54M bps
Protocol	802.11 b+g
Interface	Mini-PCI type II

Floppy Disk Drive Interface

Item	Specification		
Vendor & model name	There is no FDD module for this product		
Floppy Disk Specifications			
Media recognition	2DD (720KB)	2HD (1.2 MB, 3 mode)	2HD (1.44MB)
Sectors/track	9	15	18
Tracks	80	80	80
Data transfer rate (Kbit/s)	1 MB	1.6 MB	2 MB
Rotational speed (RPM)	300	360	300
Read/write heads	2		
Encoding method	MFM		
Power Requirement			
Input Voltage (V)	+5V		

Hard Disk Drive Interface

Item			
Vendor & Model Name	HGST MORAGA IC25N060ATMR04-0 08K0634 Seagate N2 ST960821A TOSHIBA PLUTO MK6025GAS	HGST MORAGA IC25N080ATMR04-0 08K635 Seagate N2 ST9808210A TOSHIBA PLUTO MK6025GAS	TOSHIBA PLUTO MK1031GAS SEAGATE N2 ST9100822A
Capacity (MB)	60000	80000	100000
Bytes per sector	512	512	512
Logical heads	16	16	16
Logical sectors	63	63	63
Drive Format			
Logical cylinders	16383	16383	16383

Hard Disk Drive Interface

Item			
Physical read/write heads	3/3/4	4/3/2	4
Disks	2/2/4	2/2/4	2
Spindle speed (RPM)	4200RPM	4200RPM	4200RPM
Performance Specifications			
Buffer size	8MBytes (8192kbytes)	8MBytes (8192kbytes)	8MBytes
Interface	ATA-6	ATA/ATAPI-6	ATA/ATAPI-6
Data transfer, rate (host-buffer, Mbytes/s)	100 MB/Sec	100 MB/Sec	100 MB/Sec
DC Power Requirements			
Voltage tolerance	5 +/- 5%	5 +/- 5%	5 +/- 5%

Combo Drive Interface

Item	Specification	Remark
Vendor & model name	DVD/CDRW TOSHIBA TS-L462A	
General Specification		
Interface	Enhanced IDE (ATAPI)	
Disc Diameter	8cm/12cm	
Loading Type	Drawer Type	
Drive Mounting	Horizontal/Vertical	
Read/Write	Read Speed: Max. 24X(3,600 KB/sec) for CD-ROM Max. 24X(3,600 KB/sec) for CD-RW Write Speed: Max. 24X(3,600 KB/sec) for CD-R Max. 10X(1,500 KB/sec) for CD-RW Max. 24X(3,600 KB/sec) for US-RW	CAV 24X CAV 24X P-CAV 24X/20X/16X ; CLV 10X/8X/4X CLV 10X/4X P-CAV 24X/16X
Mounting Orientation	Horizontal/Vertical	All angles
Buffer Under Run	2MB	
Power consumption	DC +5v/1.2A	
Interface	Enhanced IDE(ATAPI) compatible	
Media compatibility	CD: 120mm CD-ROM (Read Only) 80mm CD 800/700/650/550MB CD-Recordable (Read & Write) 700/650MB CD-Rewritable (Read & Write) 700/650MB High Speed CD-Rewritable (Read & Write) DVD: 5/9/10/18 DVD-Single/Dual (PTP, OTP) 3.9/4.7G DVD-R (Read Only) 4.7GDVD+R (Read Only) DVD±RW (Read only) 80mm DVD	

Combo Drive Interface

Item	Specification	Remark
Format compatibility	<p>CD CD-DA (Red Book) - Standard Audio CD & CD-TEXT CD-ROM (Yellow Book Mode1 & 2) - Standard Data CD-ROM XA (Mode2 Form1 & 2) - Photo CD, Multi-Session CD-I /FMV (Green Book, Mode2 Form1 & 2, Ready, Bridge) CD-Extra/ CD-Plus (Blue Book) - Audio & Text/Video Video-CD (White Book) - MPEG1 Video</p> <p>DVD DVD-ROM (Book 1.02), DVD-Video (Book 1.1) DVD-R (Book 1.0, 3.9G) DVD-R (Book 2.0, 4.7G) - General & Authoring DVD+R (Version 1.0) DVD±RW Play DVD-AUDIO except the case that required CPPM (Content protection for prerecorded Media) Write Method</p>	
Loading mechanism	Load: Manual Release: (a) Electrical Release (Release Button) (b) Release by ATAPI command (c) Emergency Release	
Power Requirement		
Input Voltage	DC +5V+/- 5% (operation) DC +5V+/- 8% (start up)	

DVD-RW Interface

Item	Specification
Vendor & model name	TOSHIBA TS-L532A
Performance Specification	
Transfer rate (KB/sec)	
(1) Read DVD-ROM	MAX 8X CAV (MAX 10800kB/s)
DVD-R	MAX 4X CAV (MAX 5400kB/s)
CD-ROM	MAX 24X CAV (MAX 3600kB/s)
(2) Write CD-R	4X, 8X (CLV), MAX. 24X(ZCLV)
CD-RW	4X (CLV)
HS-RW	4X, 8X, 10X (CLV)
US-RW	8X, 10X(CL), MAX. 16X (ZCLV)
(3) ATAPI Interface	
PIO mode	16.6MB/s: PIO mode4
DMA mode	16.6MB/s: Multi word mode2
Ultra DMA mode	33.3MB/s: Ultra DMA mode2
Buffer Memory	2MB
Interface	Enhanced IDE(ATAPI) compatible
Applicable disc format	Read: copy-protected DVD discs, CD-ROM, CD audio, DVD-ROM and DVD-RAM, DVD-R/-RW, DVD+R/+RW and CD-R/-RW, DVD-ROM, DVD-R/+R, DVD-R/+R, DVD-RW/+RW, 4.38GB DVD-RAM, CD-DA discs, CD-ROM discs, CD-R discs, CD-RW discs Write: CD-R, CD-RW, high-speed CD-RW, Ultra-speed CD-RW, DVD-R, DVD-RW, DVD+R, DVD+RW

DVD-RW Interface

Item	Specification
Loading mechanism	Load: Manual Release: (a) Electrical Release (Release Button) (b) Release by ATAPI command (c) Emergency Release
Power Requirement	
Input Voltage	5 V +/- 5 % (Operating)

Audio Interface

Item	Specification
Audio Controller	Realtek ALC260 (Audio amplifier: Maxim MAX9755)
Audio onboard or optional	Built-in
Mono or Stereo	Stereo
Resolution	18 bit stereo full duplex
Compatibility	HD audio Interface; S/PDIF output for PCM or AC-3 content
Sampling rate	1Hz resolution VSR (Variable Sampling Rate)
Internal microphone	Yes
Internal speaker / Quantity	Yes
Supports PnP DMA channel	DMA channel 0 DMA channel 1
Supports PnP IRQ	IRQ10, IRQ11

Video Interface

Item	Specification
Vendor & Model Name	built-in Intel [®] 915GM
Video memory size	up to 128MB for Aspire 3000/5000 up to 64MB for Aspire 3500
Chip voltage	Core / 2.5V, 1.5V,
Supports ZV (Zoomed Video) port	NO
Graph interface	4X AGP (Accelerated Graphic Port) Bus
Maximum resolution LCD	1600X1200 (UXGA)
Maximum resolution CRT	2048X1536@60HZ

Video Resolutions Mode

Monitor Resolution	Hz
2D Display Mode	
640x480	120
800x600	120
1024x768	120
1152X864	120
1280X1024	120
1600x1200	85
1920x1080*16:9	75
1920x1200	75
1920x1440	75

Video Resolutions Mode

Monitor Resolution	Hz
2048x1536	60

Resolution, colors and maximum refresh rate (Hz) in 256, 65K or 16.7M colors.

NOTE: 16:9 aspect ratio monitors are supported on 1920x1080 and 848x480 on Windows(R)XP, Windows(R) 2000 and Windows(R)ME. The complete list of resolutions depends on the driver version and operating system. **NOTE:** resolutions are limited by the performance of the attached monitor.

USB Port

Item	Specification
USB Compliancy Level	2.0
OHCI	USB 2.0
Number of USB port	3
Location	Two on the right side; one on the front side
Serial port function control	Enable/Disable by BIOS Setup

PCMCIA Port

Item	Specification
PCMCIA controller	TI PCI1510A
Supports card type	Type II (No Type III)
Number of slots	One type II
Access location	Right side
Supports ZV (Zoomed Video) port	NO
Supports 32 bit CardBus	Yes (IRQ17)

Keyboard

Item	Specification
Keyboard controller	KBC NS97551
Keyboard vendor	Darfon
Total number of keypads	88-/89-key
Windows keys	Yes
Internal & external keyboard work simultaneously	Yes

Battery

Item	Specification
Vendor & model name	SANYO PANASONIC PANASONIC (RoHS) SANYO LI-ION 4UR18650F-2-QC141 SIMPPLIO SONY
Battery Type	Lithium-ION
Pack capacity	4400mAh
Nominal voltage	14.8V
Number of battery cell	8

Battery

Item	Specification
Package configuration	4S2P for Sanyo and Panasonic 4S1P for Sanyo QC141, SIMPPLO and SONY
Package voltage	41.8V / 9.6V

LCD

Item	Specification	
Vendor & model name	AU B154EW01-08	QDI QD15TL02-03
Screen Diagonal (mm)	15.4inch	15.4inch
Active Area (mm)	331.2(H)x207.0(V)	331.2(H)x207.0(V)
Display resolution (pixels)	WXGA (1280x800)	WXGA (1280x800)
Pixel Pitch	0.2588(H)x0.2588(H)mm	0.2588(H)x0.2588(H)mm
Pixel Arrangement	RGB vertical stripe	RGB vertical stripe
Display Mode	Normally white	Normally white
Surface Treatment	Not show	glossy, hardness 2H
Typical White Luminance (cd/m ²) also called Brightness	180	160
Luminance Uniformity	not show	1.4(max)
Contrast Ratio	400	400
Response Time (Optical Rise Time/Fall Time)msec	16	25(5ms for rise+20 ms for decay)
Nominal Input Voltage VDD	not show	not show
Typical Power Consumption (watt)	6.5 (max)	4.38 (for lamp)
Weight	585	585
Physical Size(mm)	344(W)x222(H)x6.5(D)	344(W)x222(H)x6.5(D)
Support Color	Native 262K colours	262K colours
Viewing Angle (degree) Horizontal: Right/Left Vertical: Upper/Lower	40/40 10/30	45/45 15/35
Temperature Range(° C) Operating Storage (shipping)	0 to 50 -20 to 60	0 to 50 -20 to 60

AC Adapter

Item	Specification
Vendor & model name	LITE-ON PA-1650-02QR LI SHIN SLS0335A19A57LF DELTA SADP-65KB
Input Requirements	
Maximum input AC current	3.42A
Inrush current	50A @ 115Vac 100A @ 230Vac
Nominal frequency (Hz)	50-60
Frequency variation range (Hz)	47-63
Input voltage range (Vrms)	90V AC-264V AC
Inrush current	The maximum inrush current will be less than 50A and 100A when the adapter is connected to 115Vac and 230Vac respectively.

AC Adapter

Item	Specification
Efficiency	It should provide an efficiency of 83% minimum, when measured at maximum load under 115Vac.
Output Ratings (CV mode)	
DC output voltage	19V
Noise + Ripple	300mVp-pmax (20 MHz bandwidth)
Load	0(min) 3.16A(max)
Output Ratings (CC mode)	
DC output voltage	19V +/-1.0V for CV mode
Constant current mode	3.6 +/- 0.3A
Dynamic Output Characteristics	
Turn-on delay time	3 sec (@ 115Vac)
Hold up time	5ms (@115Vac, Full load)
Over Voltage Protection (OVP)	24V
Short circuit protection	3.9A max can be protected and output can be shorted without damage
Electrostatic discharge (ESD)	15KV (at air discharge) 8KV (at contact discharge)
Dielectric Withstand Voltage	
Primary to secondary	3000Vac
Leakage current	0.25 mA max. (@ 254Vac, 60Hz)
Regulatory Requirements	<p>Safety Requirements:</p> <ol style="list-style-type: none"> 1.The subject product rated 100-120V 60Hz must be listed under UL 1950 and certified with SCA Standard C22.2 No.950. 2.The subject product rated 200-240V 50Hz must comply with low voltage directive 73/23EEC. <p>EMI Requirements:</p> <ol style="list-style-type: none"> 1.The subject product rated 100-120V 60Hz must meet the EMI requirements of FCC part 15, Subpart B for Class B Digital Device and get FCC Certification before marketing into USA and Canada. 2.The subject product rated 200-240V 50Hz must meet the EMC Directive 89/336/EEC. 3.The subject product rated 100-120V must meet the VCCI-2 EMI requirements.

Power Management

ACPI Mode	Power Management
Mech. Off (G3)	All devices in the system are turned off completely.
Soft Off (G2/S5)	OS initiated shutdown. All devices in the system are turned off completely.
Working (G0/S0)	Individual devices such as the CPU and hard disk may be power managed in this state.
S3 Sleeping State	CPU set power down VGA suspend PCMCIA suspend Audio Power Down Hard Disk Power Down CD-ROM Power Down Super I/O Low Power mode
S4 Sleeping State	Also called Hibernate state. System saves all system state and data onto disk prior to power off the whole system.

Environmental Requirements

Item	Specification
Temperature	
Operating	+0~+35 °C
Non-operating	-20~+65 °C
Package storage	-20~+65 °C
Humidity	
Operating	10% to 90% RH, non-condensing
Non-operating	10% to 90% RH, non-condensing (Unpacked)
Non-operating	10% to 90% RH, non-condensing (Storage package)
Vibration	
Operating (unpacked)	Operation vibration: 1.0G ,X,Y,Zaxis, 30 minutes/axis
Non-operating (unpacked)	5~27.1Hz: 0.6G 27.1~50Hz: 0.04mm (peak to peak) 50~500Hz: 2.0G
Non-operating (packed)	5~62.6Hz: 0.51mm (peak to peak) 62.6~500Hz: 4.0G

Mechanical Specification

Item	Specification
Dimensions	364(W) x 279(D) x 33.9/38.9 (H)mm 14.3 3X 10.98x 1.33/1.53 inches
Weight	6.4 lbs (2.91kg) for 15" XGA LCD model 6.5 lbs (2.94kg) for 15.4" WXGA LCD model
I/O Ports	Three USB 2.0 ports Ethernet (RJ-45) port Modem (RJ-11) port External display (VGA) port Microphone-in jack Line-in jack Headphones/speaker/line-out jack Type II PC Card slot DC-in jack for AC adaptor
Drive Bays	One
Indicators	LED indicator for keyboard hot key: Caps Lock, Scroll Lock, Number lock LED indicator for function indicator: System power-on, HDD/ODD, Wireless on/off, Arcade LED mode, DC-in, Battery/Charging indicator
Switch	Power

System Utilities

BIOS Setup Utility

The BIOS Setup Utility is a hardware configuration program built into your computer's BIOS (Basic Input/Output System).

Your computer is already properly configured and optimized, and you do not need to run this utility. However, if you encounter configuration problems, you may need to run Setup. Please also refer to Chapter 4 Troubleshooting when problem arises.

To activate the BIOS Utility, press **F2** during POST (when "Press <F2> to enter Setup" message is prompted on the bottom of screen).

Press **F2** to enter setup. The default parameter of F12 Boot Menu is set to "disabled". If you want to change boot device without entering BIOS Setup Utility, please set the parameter to "enabled".

Press <F12> during POST to enter multi-boot menu. In this menu, user can change boot device without entering BIOS SETUP Utility.

The screenshot displays the PhoenixBIOS Setup Utility interface. At the top, the title bar reads "PhoenixBIOS Setup Utility". Below it is a navigation menu with options: "Info.", "Main", "Security", "Boot", and "Exit". The "Info." option is currently selected. The main display area shows the following system information:

```

CPU Type : Intel (R) Pentium (R) processor 1.73GHz
CPU Speed : 1733MHz
HDD Model Name: TOSHIBA MK1031GAS
HDD Serial Number : 751U0320S
ATAPI Device : HL-DT-ST DVD-RW GWA-4082N
System BIOS Version : 2A02
VGA BIOS Version : Alviso 1219
KBC Version : 1A16
Serial Number : LXT123456705290116EF00
Asset Tag Number : N/A
Produce Name : Aspire 1640
Manufacturer Name: Acer
UUID : xxxxxxxxxxxxxxxxxxxxxxxxxxxxxxxxxxxxxxxx
  
```

At the bottom of the screen, a legend defines the keyboard shortcuts:

```

F1 Help      ↑↓ Select Item      F5/F6 Change Values      F9 Setup Defaults
Esc Exit     ←→ Select Menu     Enter Select  ▶ Sub-Menu  F10 Save and Exit
  
```

Navigating the BIOS Utility

There are six menu options: Info., Main, System Devices, Security, Boot, and Exit.

Follow these instructions:

- To choose a menu, use the cursor left/right keys (← →).
- To choose a parameter, use the cursor up/down keys (↑ ↓).
- To change the value of a parameter, press F5 or F6.
- A plus sign (+) indicates the item has sub-items. Press ENTER to expand this item.
- Press ESC while you are in any of the menu options to go to the Exit menu.
- In any menu, you can load default settings by pressing F9. You can also press F10 to save any changes made and exit the BIOS Setup Utility.

NOTE: You can change the value of a parameter if it is enclosed in square brackets. Navigation keys for a particular menu are shown on the bottom of the screen. Help for parameters are found in the Item Specific Help part of the screen. Read this carefully when making changes to parameter values. Please note that system information vary in models.

Information

PhoenixBIOS Setup Utility

Info.
Main
Security
Boot
Exit

```

CPU Type :           Intel (R) Pentium (R) processor 1.73GHz
CPU Speed :          1733MHz
HDD Model Name:      TOSHIBA MK1031GAS
HDD Serial Number :  751U0320S
ATAPI Device :       HL-DT-ST DVD-RW GWA-4082N
System BIOS Version : 2A02
VGA BIOS Version :   Alviso 1219
KBC Version :        1A16
Serial Number :      LXT123456705290116EF00
Asset Tag Number :   N/A
Produce Name         Aspire 1640
Manufacturer Name:   Acer
UUID :               xxxxxxxxxxxxxxxxxxxxxxxxxxxxxxxxxxxxxxxx
                    
```

F1 Help
↑↓ Select Item
F5/F6 Change Values
F9 Setup Defaults

Esc Exit
←→ Select Menu
Enter Select ▶ Sub-Menu
F10 Save and Exit

NOTE: The system information is subject to different models.

Parameter	Description
HDD Model Name	This field shows the model name of HDD installed on primary IDE master.
HDD Serial Number	This field displays the serial number of HDD installed on primary IDE master.
ATAPI Device	This field displays the model name of devices installed on secondary IDE master. The hard disk drive or optical drive model name is automatically detected by the system.
System BIOS Version	This field displays the BIOS version of the system.
VGA BIOS Version	This field displays the VGA BIOS version of this system.
KBC Version	This field displays the KBC version of this system.
ATAPI Serial Number	This field shows the serial number of devices installed on secondary IDE master.
Serial Number	This field displays the serial number of this unit.
Asset Tag Number	An Asset Tag with 32 bytes will be stored in EEPROM. Default value is set as "0000000000000000" (in binary code).

Parameter	Description
UUID Number	This will be visible only when there is an internal LAN device present. UUID means Universally Unique ID, a method for computing object identifiers (OIDs). It uses the serial number in the local Ethernet card combined with the date and time to generate a 128 bit (16bytes) number. For Acer product, this field displays UUID number. A UUID string will be stored in the secured data area which is an alphanumeric string of maximum 16 bytes in length.

Main

The Main screen displays a summary of your computer hardware information, and also includes basic setup parameters. It allows the user to specify standard IBM PC AT system parameters.

PhoenixBIOS Setup Utility				
Information	Main	Security	Boot	Exit
				Item Specific Help
System Time:	[05:45:48]			
System Date:	[08/30/2005]			
System Memory:	640 KB	Shows system base memory size		
Extended Memory:	1040 MB	Shows extended memory size		
Video Memory	[128MB]	VGA memory size		
Quiet Boot:	[Enabled]			
Power On Display:	[Both]			
Network Boot	[Enabled]			
F12 Boot Menu	[Disabled]			
D2D Recovery	[Enabled]			
<Tab>, <Shift-Tab>, or <Enter> selects field.				
F1 Help	↑↓ Select Item	F5/F6 Change Values	F9 Setup Defaults	
Esc Exit	←→ Select Menu	Enter Select	▶ Sub-Menu	F10 Save and Exit

NOTE: The screen above is for reference only. Actual values may differ.

The table below describes the parameters in this screen. Settings in **boldface** are the default and suggested parameter settings.

Parameter	Description	Format/Option
System Time	Sets the system time. The hours are displayed with 24-hour format.	Format: HH:MM:SS (hour:minute:second) System Time
System Date	Sets the system date.	Format MM/DD/YYYY (month/day/year) System Date
System Memory	This field reports the memory size of the system. Memory size is fixed to 640MB	
Extended Memory	This field reports the memory size of the extended memory in the system. Extended Memory size=Total memory size-1MB	
VGA Memory	Shows the VGA memory size. VGA Memory size=64/128MB	
Quiet Boot	Determines if Customer Logo will be displayed or not; shows Summary Screen is disabled or enabled. Enabled: Customer Logo is displayed, and Summary Screen is disabled. Disabled: Customer Logo is not displayed, and Summary Screen is enabled.	Option: Enabled or Disabled
Power on display	Auto: During power process, the system will detect if any display device is connected on external video port. If any external display device is connected, the power on display will be in CRT (or projector) only mode. Otherwise it will be in LCD only mode. Both: Simultaneously enable both the integrated LCD screen and the system's external video port (for an external CRT or projector).	Option: Both or Auto
Network Boot	Enables, disables the system boot from LAN (remote server).	Option: Enabled or Disabled
F12 Boot Menu	Enables, disables Boot Menu during POST.	Option: Disabled or Enabled
D2D Recovery	Enables, disables D2D Recovery function. The function allows the user to create a hidden partition on hard disc drive to store operation system and restore the system to factory defaults.	Option: Enabled or Disabled

NOTE: The sub-items under each device will not be shown if the device control is set to disable or auto. This is because the user is not allowed to control the settings in these cases.

Security

The Security screen contains parameters that help safeguard and protect your computer from unauthorized use.

PhoenixBIOS Setup Utility				
Information	Main	Security	Boot	Exit
				Item Specific Help
Supervisor Password Is :		Clear		
User Password Is :		Clear		
HDD Password Is :		Clear		
HDD Master ID :		15422442		
Set Supervisor Password		[Enter]		
Set User Password		[Enter]		
Set HDD Password		[Enter]		
Password on Boot		[Disabled]		
				Supervisor Password controls accesses of the whole setup utility. It can be used to boot up when Password on boot is enabled.
F1 Help	↑ ↓ Select Item	F5/F6 Change Values	F9 Setup Defaults	
Esc Exit	← → Select Menu	Enter Select ▶ Sub-Menu	F10 Save and Exit	

The table below describes the parameters in this screen. Settings in **boldface** are the default and suggested parameter settings.

Parameter	Description	Option
User Password Is	Shows the setting of the user password.	Clear or Set
Supervisor Password Is	Shows the setting of the Supervisor password. Please note that Supervisor Password controls access to the entire Setup. The Supervisor Password can be used to boot up when Password on boot is set to enabled.	Clear or Set
HDD Password Is	Shows the setting of the HDD password.	Clear or Set
Set User Password	Press Enter to set the user password. When user password is set, this password protects the BIOS Setup Utility from unauthorized access. The user can enter Setup menu only and does not have right to change the value of parameters.	
Set Supervisor Password	Press Enter to set the supervisor password. When set, this password protects the BIOS Setup Utility from unauthorized access. The user can not either enter the Setup menu nor change the value of parameters.	
Set HDD Password	Press Enter to set the HDD password.	
Primary Harddisk Security	This feature is available to user when Supervisor password is set. Password can be written on HDD only when Supervisor password or user password is set and password on HDD is set to enabled. Supervisor Password is written to HDD only when Supervisor password is being set. User password is written to HDD when both passwords are set. When both Supervisor and user password are present, both passwords can unlock the HDD.	Disabled or Enabled
Password on Boot	Defines whether a password is required or not while the events defined in this group happened. The following sub-options are all requires the Supervisor password for changes and should be grayed out if the user password was used to enter setup.	Disabled or Enabled

NOTE: When you are prompted to enter a password, you have three tries before the system halts. Don't forget your password. If you forget your password, you may have to return your notebook computer to your dealer to reset it.

NOTE: The User Password can change the following items in BIOS: System Date, System Time and Power on Display on Main menu, System Devices menu and Set User Password function on Security menu. Meanwhile, the Supervisor Password can change ALL settings in BIOS.

Setting a Password



Follow these steps as you set the user or the supervisor password:

1. Use the **↑** and **↓** keys to highlight the Set Supervisor Password parameter and press the **ENTER** key. The Set Supervisor Password box appears:

Set Supervisor Password		
Enter New Password	[]
Confirm New Password	[]



2. Type a password in the “Enter New Password” field. The password length can not exceeds 8 alphanumeric characters (A-Z, a-z, 0-9, not case sensitive). Retype the password in the “Confirm New Password” field.

IMPORTANT: Be very careful when typing your password because the characters do not appear on the screen.



3. Press  .
After setting the password, the computer sets the User Password parameter to “Set”.
4. If desired, you can opt to enable the Password on boot parameter.
5. When you are done, press  to save the changes and exit the BIOS Setup Utility.

Removing a Password



Follow these steps:

1. Use the  and  keys to highlight the Set Supervisor Password parameter and press the  key. The Set Password box appears:

Set Supervisor Password		
Enter current password	[]
Enter New Password	[]
Confirm New Password	[]

2. Type the current password in the Enter Current Password field and press  .
3. Press  twice **without** typing anything in the Enter New Password and Confirm New Password fields. The computer then sets the Supervisor Password parameter to “Clear”.
4. When you have changed the settings, press  to save the changes and exit the BIOS Setup Utility.

Changing a Password

1. Use the  and  keys to highlight the Set Supervisor Password parameter and press the  key. The Set Password box appears:

Set Supervisor Password		
Enter current password	[]
Enter New Password	[]
Confirm New Password	[]

2. Type the current password in the Enter Current Password field and press  .

-
3. Type a password in the Enter New Password field. Retype the password in the Confirm New Password field.
 4. Press **ENTER**. After setting the password, the computer sets the User Password parameter to "Set".
 5. If desired, you can enable the Password on boot parameter.
 6. When you are done, press **F10** to save the changes and exit the BIOS Setup Utility.

If the verification is OK, the screen will display as following.

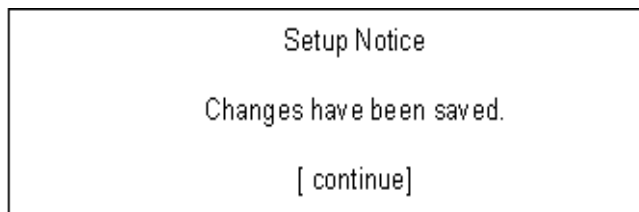

The password setting is complete after the user presses **F10**.

If the current password entered does not match the actual current password, the screen will show you the Setup Warning.

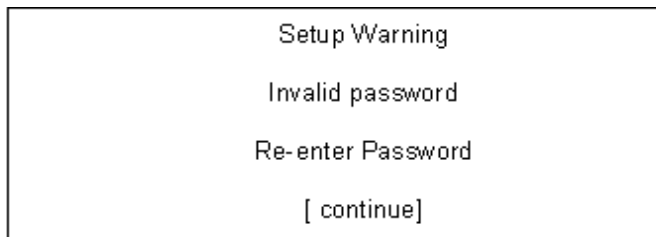

If the new password and confirm new password strings do not match, the screen will display the following message.

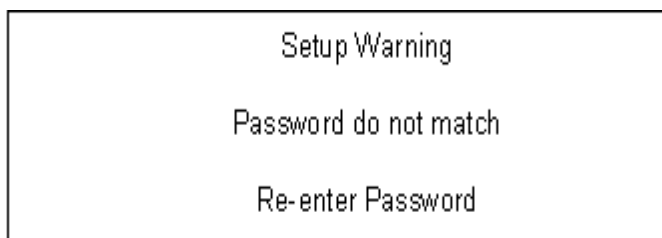

Boot

This menu allows the user to decide the order of boot devices to load the operating system. Bootable devices includes the distette drive in module bay, the onboard hard disk drive and the CD-ROM in module bay.

PhoenixBIOS Setup Utility					
Info.	Main	Advanced	Security	Boot	Exit
CD-ROM/DVD Drive Floppy Devices +Hard Drive Network Boot				Item Specific Help	
				+ and - indicate device categories. Use <Enter> to expand/collapses. Boot order is top-down using only the top device in each category. Use <F6> and <F5> to move highlighted item up and down.	
F1 Help	↑↓ Select Item	F5/F6 Change Values	F9 Setup Defaults		
Esc Exit	←→ Select Menu	Enter Select	▶ Sub-Menu	F10 Save and Exit	

Exit

The Exit screen contains parameters that help safeguard and protect your computer from unauthorized use.

PhoenixBIOS Setup Utility					
Info.	Main	Advanced	Security	Boot	Exit
Exit Saving Changes Exit Discarding Changes Load Setup Defaults Discard Changes Save Changes					Item Specific Help Exit System Setup and save your changes to CMOS.
F1 Help	↑↓ Select Item	F5/F6 Change Values	F9 Setup Defaults		
Esc Exit	←→ Select Menu	Enter Select ▶ Sub-Menu	F10 Save and Exit		

The table below describes the parameters in this screen.

Parameter	Description
Exit Saving Changes	Exit System Setup and save your changes to CMOS.
Exit Discarding Changes	Exit utility without saving setup data to CMOS.
Load Setup Default	Load default values for all SETUP item.
Discard Changes	Load previous values from CMOS for all SETUP items.
Save Changes	Save Setup Data to CMOS.

BIOS Flash Utility

The BIOS flash memory update is required for the following conditions:

- New versions of system programs
- New features or options
- Restore a BIOS when it becomes corrupted.

Use the Phlash utility to update the system BIOS flash ROM.

NOTE: If you do not have a crisis recovery diskette at hand, then you should create a **Crisis Recovery Diskette** before you use the Phlash utility.

NOTE: Do not install memory-related drivers (XMS, EMS, DPMS) when you use the Phlash.

NOTE: Please use the AC adaptor power supply when you run the Phlash utility. If the battery pack does not contain enough power to finish BIOS flash, you may not boot the system because the BIOS is not completely loaded.

Create Crisis Recovery Diskette

1. Rename BIOS file of this product to BIOS.wph
2. Copy BIOS.wph file to crisis folder and overwrite the original BIOS.wph file.
3. Insert a blank floppy diskette to floppy drive.
4. Run cs.bat and follow its instructions to create crisis recovery diskette.

Recover BIOS from Crisis Recovery Diskette

1. Insert the crisis recovery diskette to the floppy drive.
2. Use AC adaptor power supply.
3. Press Fn and ESC key together for more than two seconds when you power on the system.
4. The system will read the files inside the floppy diskette without backlight.
5. After one to three minutes, the system will automatically reboot. Please do not shut down the system or remove the power supply.
6. After step 1 to 5, you should be able to recover BIOS already. Then you can see the LCD screen with the backlight is on.

Machine Disassembly and Replacement

This chapter contains step-by-step procedures on how to disassemble the notebook computer for maintenance and troubleshooting.

To disassemble the computer, you need the following tools:

- Wrist grounding strap and conductive mat for preventing electrostatic discharge
- Flat-bladed screw driver
- Phillips screw driver
- Tweezers
- Plastic Flat-bladed screw driver
- Hexed Screw Driver

NOTE: The screws for the different components vary in size. During the disassembly process, group the screws with the corresponding components to avoid mismatch when putting back the components.

General Information

Before You Begin

Before proceeding with the disassembly procedure, make sure that you do the following:

1. Turn off the power to the system and all peripherals.
2. Unplug the AC adapter and all power and signal cables from the system

NOTE: Aspire 9100 series product uses mylar or tape to fasten the FFC/FPC/connectors/cable, you may need to tear the tape or mylar before you disconnect different FFC/FPC/connectors.

Disassembly Procedure Flowchart

The flowchart on the succeeding page gives you a graphic representation on the entire disassembly sequence and instructs you on the components that need to be removed during servicing. For example, if you want to remove the main board, you must first remove the keyboard, then disassemble the inside assembly frame in that order.

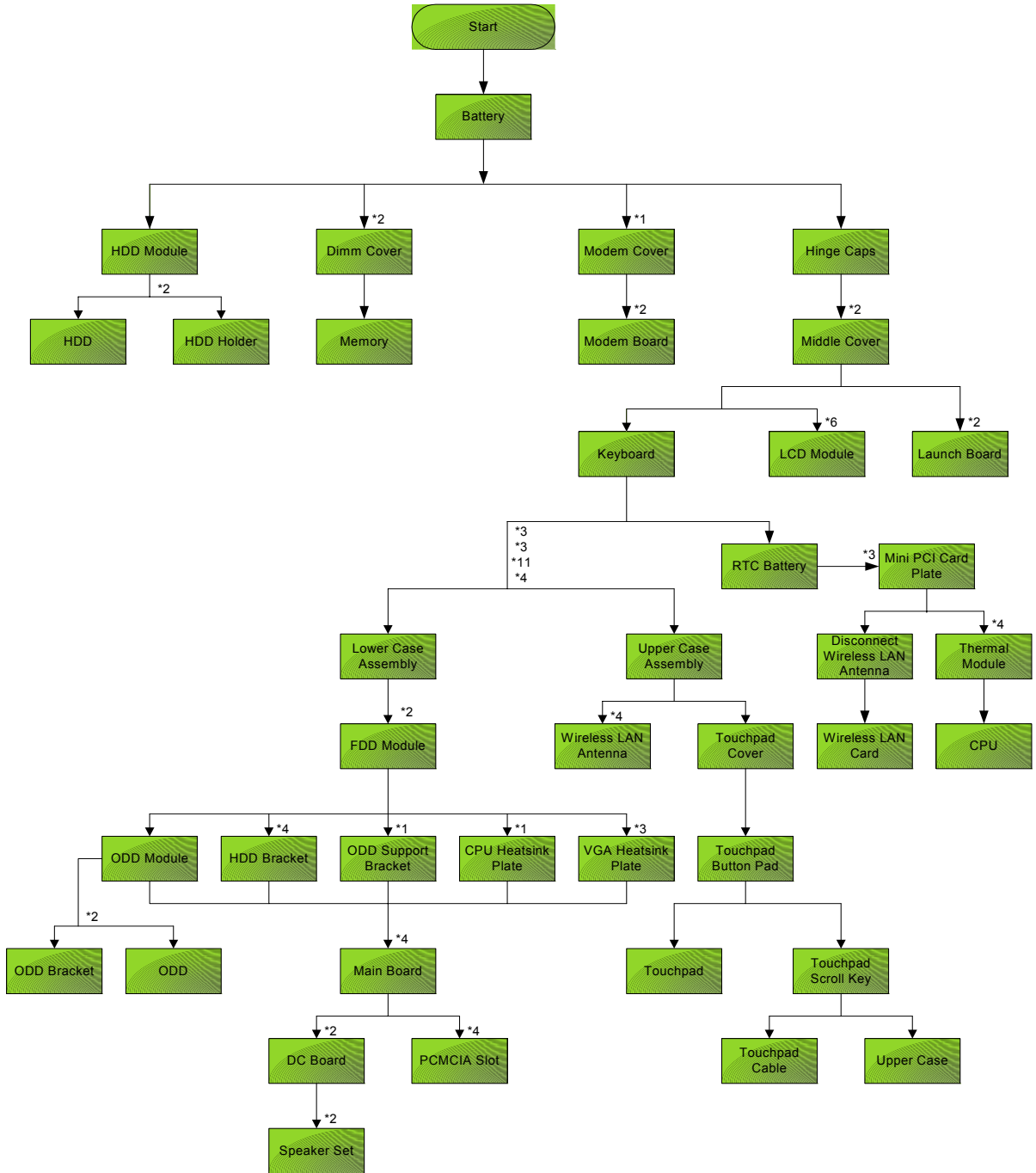

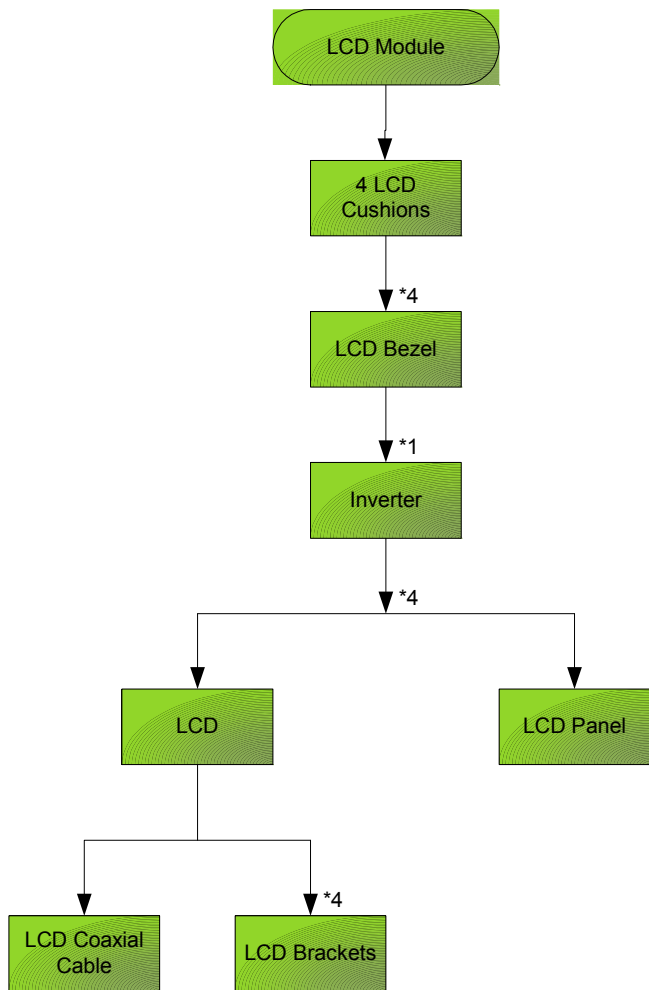

Screw List

Item	Description
A	SCREW F040 9 5.0X5.0 9.5X(IO) R00
B	SCREW M2.0X0.4P+3FP ZK(NL)
C	SCREW M2.5 K 5/2 X0.85 4 ZK(NL)
D	SCREW M2.5X0.45+10K NIL
E	SCREW M2.5X0.45+8K ZBL
F	SCREW M2.5X0.45P+3F NI
G	SCREW M3.0X0.8P+3K NL

Removing the Battery

1. Unlatch the battery latch then remove the battery.



Removing the Hard Disc Drive Module

1. See “Removing the Battery” on page 56.
2. Remove the screw securing the hard disk drive (HDD) cover.
3. Then remove the HDD cover.

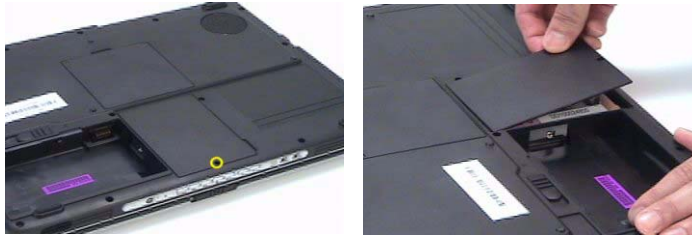

4. Pull the HDD module backwards as shown.
5. Remove the HDD module.

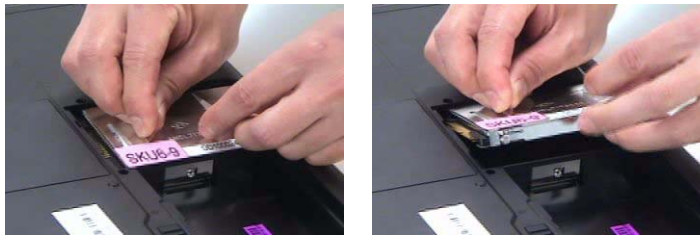

Disassembling the Hard Disc Drive Module

1. Remove two screw securing the HDD bracket.
2. Remove the other two screw on the other side.
3. Take out the HDD from the HDD bracket.



Removing the Optical Disc Drive Module

1. See “Removing the Battery” on page 56.
2. See “Removing the Hard Disc Drive Module” on page 57.
3. Remove the screw securing the optical disc drive (ODD) module.
4. Push the ODD module outwards with a flat headed screw driver.
5. Then remove the ODD module.



Disassembling the Optical Disc Drive Module

1. Remove two screws securing the ODD bracket.
2. Then remove the ODD bracket.



Removing the Memory

1. See “Removing the Battery” on page 56.
2. Remove the two screws securing the DIMM cover then remove the DIMM cover.
3. Pop out the memory.
4. Then remove the memory from the DIMM socket.



Removing the LCD Module

Removing the Middle Cover

1. See “Removing the Battery” on page 56.
2. Open the notebook as image shows.
3. Detach the middle cover carefully then remove it.



Removing the Keyboard

1. See “Removing the Battery” on page 56.
2. See “Removing the Middle Cover” on page 60.
3. Remove the four screws securing the keyboard.
4. Turn the keyboard over as shown.
5. Disconnect the keyboard cable then remove the keyboard.

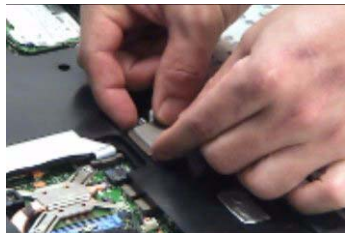

Removing the Fan, the CPU Thermal Module and the CPU

1. See “Removing the Battery” on page 56.
2. See “Removing the Middle Cover” on page 60.
3. See “Removing the Keyboard” on page 60.
4. Remove the three screws securing the system fan.
5. Disconnect the fan cable.
6. Then detach the fan from the main unit.

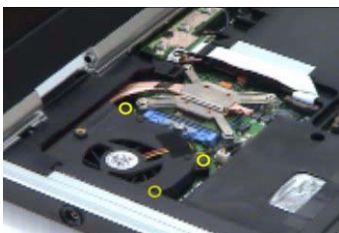

7. Remove the four screws securing the CPU thermal module.
8. Then remove the CPU thermal module.

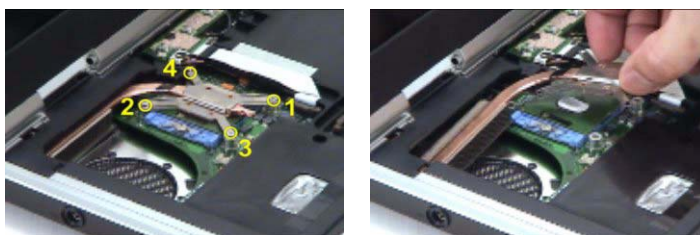

NOTE: Please remove the screws in the order that the image indicates. Start from 4, 3, 2 then 1. When you reassemble the CPU thermal module, secure the screws as the order: 1, 2, 3 then 4. This can help you average the force to each screw, therefore the CPU module can be secured well.

9. Release the CPU lock with a flat headed screw driver.
10. Then detach the CPU from the socket carefully.

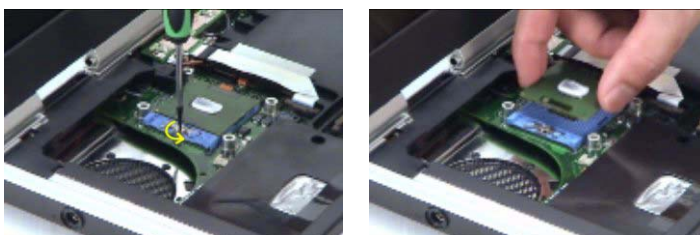

Removing the Wireless LAN Card

1. See “Removing the Battery” on page 56.
2. See “Removing the Middle Cover” on page 60.
3. Pop out the wireless LAN card.
4. Disconnect the main and the auxiliary antennae.
5. Then remove the wireless LAN card from the main unit.



Removing the LCD Module

1. See “Removing the Battery” on page 56.
2. See “Removing the Middle Cover” on page 60.
3. See “Removing the Keyboard” on page 60.
4. Disconnect the inverter cable with a flat headed screw driver.
5. Take out the LVDS cable then disconnect the LVDS cable.

6. Tear off the tape securing the wireless LAN antennae then release the antennae.

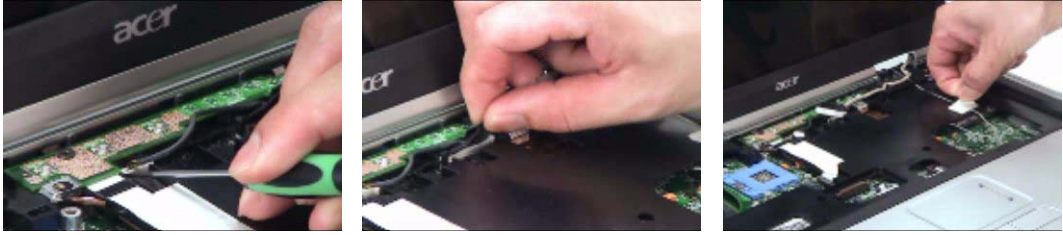

7. Remove the two screws securing the LCD module on the rear side.
8. Remove the two screws securing the LCD module on the bottom.
9. Then detach the LCD module carefully.



Disassembling the LCD Module

Removing the LCD Bezel

1. See “Removing the Battery” on page 56.
2. See “Removing the Middle Cover” on page 60.
3. See “Removing the Keyboard” on page 60.
4. See “Removing the Fan, the CPU Thermal Module and the CPU” on page 60.
5. See “Removing the Wireless LAN Card” on page 61.
6. See “Removing the LCD Module” on page 61.
7. Detach the two rubber pads and the two screw pads.
8. Remove the four screws securing the LCD bezel.
9. Detach the LCD bezel carefully.



10. Remove the nine screws securing the LCD to the LCD panel.
11. Take out the LCD assembly from the LCD panel.
12. Disconnect the LCD inverter cable.



13. Disconnect the LCD inverter board.
14. Turn over the LCD.
15. Disconnect the LCD cable.



16. Remove the four screws securing the right LCD bracket, then remove the right bracket.
17. Remove the four screws securing the left LCD bracket, then remove the left bracket.

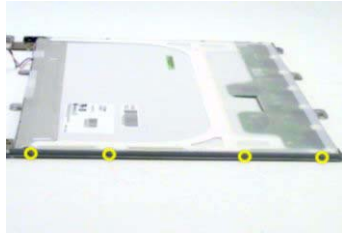
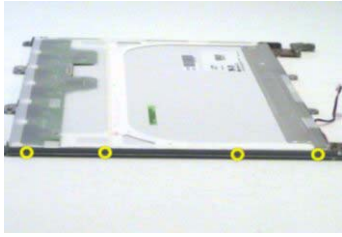

Disassembling the Main Unit

Removing the Upper Case Assembly

1. See “Removing the Battery” on page 56..
2. See “Removing the Hard Disc Drive Module” on page 57.
3. See “Removing the Optical Disc Drive Module” on page 58.
4. See “Removing the Memory” on page 59.
5. See “Removing the LCD Module” on page 60.
6. Remove the fifteen screws securing the lower case assembly and the upper case assembly on the bottom.
7. Remove the three screws securing the upper case assembly.

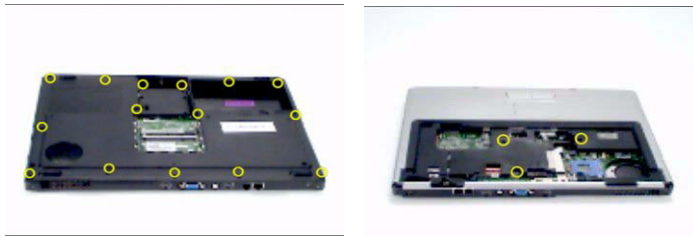

8. Disconnect the touchpad cable.
9. Disconnect the power board cable.
10. Then detach the upper case assembly.



Removing the Power Board

1. See “Removing the Battery” on page 56.
2. See “Removing the Hard Disc Drive Module” on page 57.
3. See “Removing the Optical Disc Drive Module” on page 58.
4. See “Removing the Memory” on page 59.
5. See “Removing the LCD Module” on page 60.
6. Remove the two screws securing the power board.
7. Tear off the tape holding the power board cable then remove the power board.

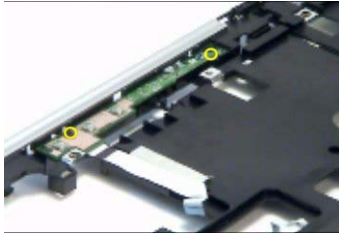

Removing the Touchpad Bracket, the Touchpad Board and the Touchpad

1. See “Removing the Battery” on page 56.
2. See “Removing the Middle Cover” on page 60.
3. See “Removing the Keyboard” on page 60.
4. See “Removing the Power Board” on page 65.
5. See “Removing the Upper Case Assembly” on page 65.
6. Pull back the tape covering the touchpad FFC.
7. Disconnect the touchpad FFC the remove it.

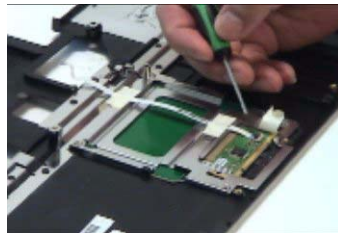
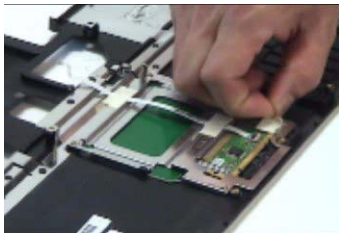

8. Remove the four screws securing the touchpad bracket.
9. Slide the touchpad bracket back as shown.
10. Then remove the touchpad bracket.

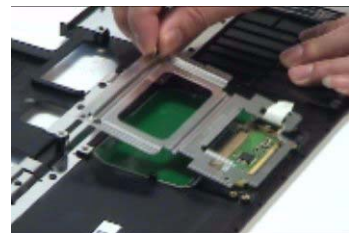
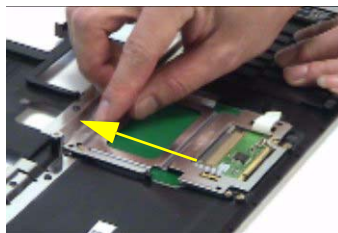
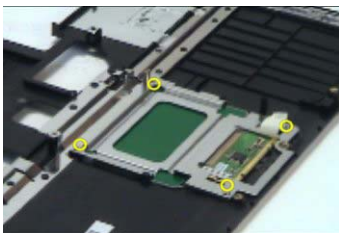

11. Use a flat headed screw driver to detach the touchpad board.
12. Then detach the touchpad carefully.

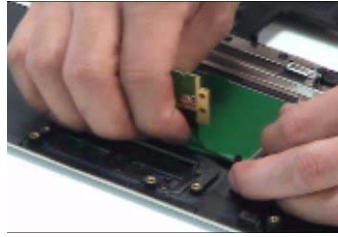
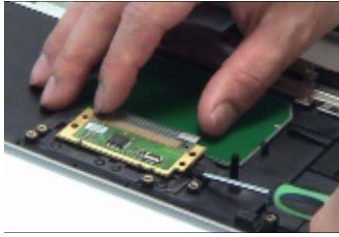

Removing the Speaker Set

1. See “Removing the Battery” on page 56.
2. See “Removing the Middle Cover” on page 60.
3. See “Removing the Keyboard” on page 60.
4. See “Removing the Power Board” on page 65.
5. See “Removing the Upper Case Assembly” on page 65.
6. Disconnect the SW DJ board cable.
7. Disconnect the CIR receiver cable.
8. Then disconnect the audio board FFC cable.

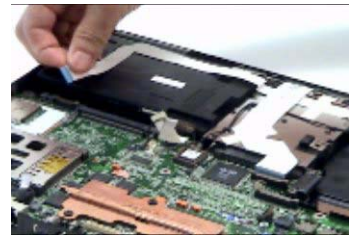
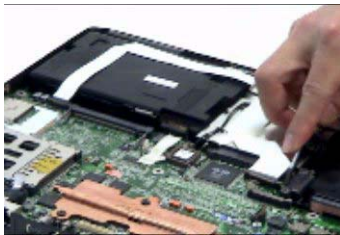

9. Disconnect the speaker set cable.
10. Then detach the speaker set from the lower case.

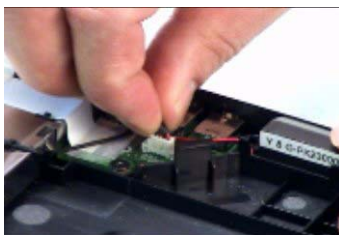

Removing the SW DJ Board Assembly

1. See “Removing the Battery” on page 56.
2. See “Removing the Middle Cover” on page 60.
3. See “Removing the Keyboard” on page 60.
4. See “Removing the Power Board” on page 65.
5. See “Removing the Upper Case Assembly” on page 65.
6. See “Removing the Speaker Set” on page 67.
7. Remove the two screws securing the SW DJ board assembly.

8. Remove the SW DJ board assembly from the lower case.

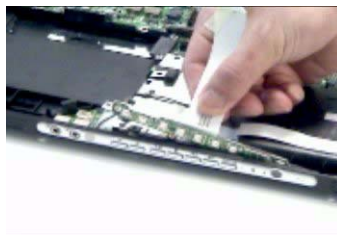
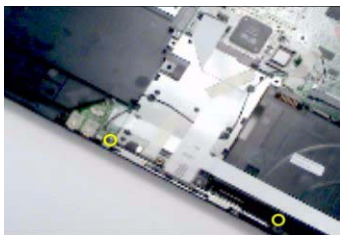

9. Remove the two screws securing the SW DJ board and SW DJ board bracket.
10. Then remove the SW DJ board.



Removing the Audio Board

1. See “Removing the Battery” on page 56.
2. See “Removing the Middle Cover” on page 60.
3. See “Removing the Keyboard” on page 60.
4. See “Removing the Power Board” on page 65.
5. See “Removing the Upper Case Assembly” on page 65.
6. See “Removing the Speaker Set” on page 67.
7. See “Removing the SW DJ Board Assembly” on page 67.
8. Remove the screw securing the audio board.
9. Detach the audio board FFC.
10. Release the CIR receiver cable.
11. Then detach the audio board.



Removing the VGA Thermal Module

1. See “Removing the Battery” on page 56.
2. See “Removing the Middle Cover” on page 60.
3. See “Removing the Keyboard” on page 60.

4. See “Removing the Power Board” on page 65.
5. See “Removing the Upper Case Assembly” on page 65.
6. Remove the three screws securing the VGA thermal module.
7. Then detach the VGA thermal module.

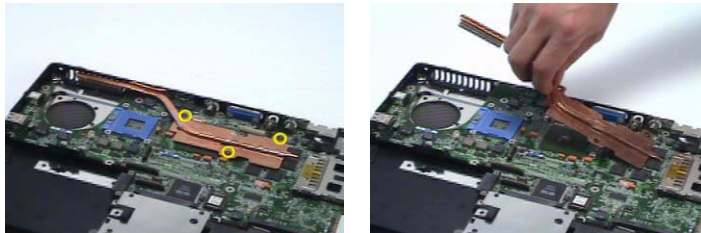

Removing the Modem Board

1. See “Removing the Battery” on page 56.
2. See “Removing the Middle Cover” on page 60.
3. See “Removing the Keyboard” on page 60.
4. See “Removing the Power Board” on page 65.
5. See “Removing the Upper Case Assembly” on page 65.
6. Remove the two screws securing the modem board.
7. Disconnect the modem board connector.
8. Disconnect the modem board cable then remove the board.



Removing the Main Board

1. See “Removing the Battery” on page 56.
2. See “Removing the Middle Cover” on page 60.
3. See “Removing the Keyboard” on page 60.
4. See “Removing the Power Board” on page 65.
5. See “Removing the Upper Case Assembly” on page 65.
6. See “Removing the Speaker Set” on page 67.
7. See “Removing the SW DJ Board Assembly” on page 67.
8. See “Removing the Audio Board” on page 68.
9. See “Removing the VGA Thermal Module” on page 68.
10. See “Removing the Modem Board” on page 69.
11. Remove the two nut screws securing the main board.
12. Press the PCMCIA card button.

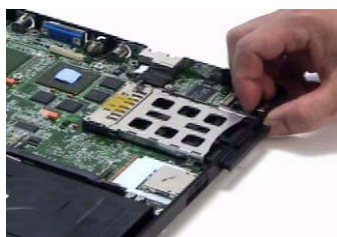

13. Remove the dummy card.
14. Remove the two screws securing the main board to the lower case.
15. Then detach the main board from the lower case carefully.



Removing the Control Board

1. See "Removing the Battery" on page 56.
2. See "Removing the Middle Cover" on page 60.
3. See "Removing the Keyboard" on page 60.
4. See "Removing the Power Board" on page 65.
5. See "Removing the Upper Case Assembly" on page 65.
6. See "Removing the Speaker Set" on page 67.
7. See "Removing the SW DJ Board Assembly" on page 67.
8. See "Removing the Audio Board" on page 68.
9. See "Removing the VGA Thermal Module" on page 68.
10. See "Removing the Modem Board" on page 69.
11. See "Removing the Main Board" on page 69.
12. Turn over the main board as shown.
13. Disconnect the control board antenna.
14. Pop out the control board then remove it.

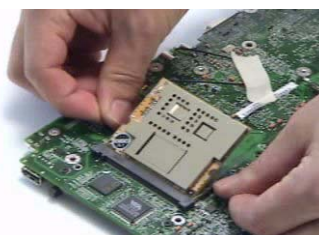

Troubleshooting

Use the following procedure as a guide for computer problems.

NOTE: The diagnostic tests are intended to test only Acer products. Non-Acer products, prototype cards, or modified options can give false errors and invalid system responses.

1. Obtain the failing symptoms in as much detail as possible.
2. Verify the symptoms by attempting to re-create the failure by running the diagnostic test or by repeating the same operation.
3. Use the following table with the verified symptom to determine which page to go to.

Symptoms (Verified)	Go To
Power failure. (The power indicator does not go on or stay on.)	"Power System Check" on page 74.
POST does not complete. No beep or error codes are indicated.	"Power-On Self-Test (POST) Error Message" on page 77 "Undetermined Problems" on page 89
POST detects an error and displayed messages on screen.	"Error Message List" on page 78
Other symptoms (i.e. LCD display problems or others).	"Power-On Self-Test (POST) Error Message" on page 77
Symptoms cannot be re-created (intermittent problems).	Use the customer-reported symptoms and go to "Power-On Self-Test (POST) Error Message" on page 77 "Intermittent Problems" on page 88 "Undetermined Problems" on page 89

System Check Procedures

External Diskette Drive Check

Do the following to isolate the problem to a controller, driver, or diskette. A write-enabled, diagnostic diskette is required.

NOTE: Make sure that the diskette does not have more than one label attached to it. Multiple labels can cause damage to the drive or cause the drive to fail.

Do the following to select the test device.

1. Boot from the diagnostics diskette and start the diagnostics program.
2. See if FDD Test is passed as the program runs to FDD Test.
3. Follow the instructions in the message window.

If an error occurs with the internal diskette drive, reconnect the diskette connector on the system board.

If the error still remains:

1. Reconnect the external diskette drive/DVD-ROM module.
2. Replace the external diskette drive/CD-ROM module.
3. Replace the main board.

External CD-ROM Drive Check

Do the following to isolate the problem to a controller, drive, or CD-ROM. Make sure that the CD-ROM does not have any label attached to it. The label can cause damage to the drive or can cause the drive to fail.

Do the following to select the test device:

1. Boot from the diagnostics diskette and start the diagnostics program.
2. See if CD-ROM Test is passed when the program runs to CD-ROM Test.
3. Follow the instructions in the message window.

If an error occurs, reconnect the connector on the System board. If the error still remains:

1. Reconnect the external diskette drive/CD-ROM module.
2. Replace the external diskette drive/CD-ROM module.
3. Replace the main board.

Keyboard or Auxiliary Input Device Check

Remove the external keyboard if the internal keyboard is to be tested.

If the internal keyboard does not work or an unexpected character appears, make sure that the flexible cable extending from the keyboard is correctly seated in the connector on the system board.

If the keyboard cable connection is correct, run the Keyboard Test.

If the tests detect a keyboard problem, do the following one at a time to correct the problem. Do not replace a non-defective FRU:

1. Reconnect the keyboard cables.
2. Replace the keyboard.
3. Replace the main board.

The following auxiliary input devices are supported by this computer:

- Numeric keypad
- External keyboard

If any of these devices do not work, reconnect the cable connector and repeat the failing operation.

Memory check

Memory errors might stop system operations, show error messages on the screen, or hang the system.

1. Boot from the diagnostics diskette and start the doagmpstotics program (please refer to main board).
2. Go to the diagnostic memory in the test items.
3. Press F2 in the test items.
4. Follow the instructions in the message window.

NOTE: Make sure that the DIMM is fully installed into the connector. A loose connection can cause an error.

Power System Check

To verify the symptom of the problem, power on the computer using each of the following power sources:

1. Remove the battery pack.
2. Connect the power adapter and check that power is supplied.
3. Disconnect the power adapter and install the charged battery pack; then check that power is supplied by the battery pack.

If you suspect a power problem, see the appropriate power supply check in the following list:

- “Check the Power Adapter” on page 75
- “Check the Battery Pack” on page 76

Check the Power Adapter

Unplug the power adapter cable from the computer and measure the output voltage at the plug of the power adapter cable. See the following figure

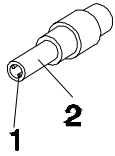

Pin 1: +19 to +20.5V
Pin 2: 0V, Ground

1. If the voltage is not correct, replace the power adapter.
2. If the voltage is within the range, do the following:
 - Replace the System board.
 - If the problem is not corrected, see “Undetermined Problems” on page 89.
 - If the voltage is not correct, go to the next step.

NOTE: An audible noise from the power adapter does not always indicate a defect.

3. If the power-on indicator does not light up, check the power cord of the power adapter for correct continuity and installation.
4. If the operational charge does not work, see “Check the Battery Pack” on page 76.

Check the Battery Pack

To check the battery pack, do the following:

From Software:

1. Check out the Power Management in control Panel
2. In Power Meter, confirm that if the parameters shown in the screen for Current Power Source and Total Battery Power Remaining are correct.
3. Repeat the steps 1 and 2, for both battery and adapter.
4. This helps you identify first the problem is on recharging or discharging.

From Hardware:

1. Power off the computer.
2. Remove the battery pack and measure the voltage between battery terminals 1(+) and 6(ground).
3. If the voltage is still less than 7.5 Vdc after recharging, replace the battery.

To check the battery charge operation, use a discharged battery pack or a battery pack that has less than 50% of the total power remaining when installed in the computer.

If the battery status indicator does not light up, remove the battery pack and let it return to room temperature. Re-install the battery pack.

If the charge indicator still does not light up, replace the battery pack. If the charge indicator still does not light up, replace the DC/DC charger board.

Touchpad Check

If the touchpad doesn't work, do the following actions one at a time to correct the problem. Do not replace a non-defective FRU:

1. Reconnect the touchpad cables.
2. Replace the touchpad.
3. Replace the system board.

After you use the touchpad, the pointer drifts on the screen for a short time. This self-acting pointer movement can occur when a slight, steady pressure is applied to the touchpad pointer. This symptom is not a hardware problem. No service actions are necessary if the pointer movement stops in a short period of time.

Power-On Self-Test (POST) Error Message

The POST error message index lists the error message and their possible causes. The most likely cause is listed first.

NOTE: Perform the FRU replacement or actions in the sequence shown in FRU/Action column, if the FRU replacement does not solve the problem, put the original part back in the computer. Do not replace a non-defective FRU.

This index can also help you determine the next possible FRU to be replaced when servicing a computer.

If the symptom is not listed, see “Undetermined Problems” on page 89.

The following lists the error messages that the BIOS displays on the screen and the error symptoms classified by function.

NOTE: Most of the error messages occur during POST. Some of them display information about a hardware device, e.g., the amount of memory installed. Others may indicate a problem with a device, such as the way it has been configured.

NOTE: If the system fails after you make changes in the BIOS Setup Utility menus, reset the computer, enter Setup and install Setup defaults or correct the error.

Index of Error Messages

Error Code List

Error Codes	Error Messages
006	Equipment Configuration Error Causes: 1. CPU BIOS Update Code Mismatch 2. IDE Primary Channel Master Drive Error (The causes will be shown before "Equipment Configuration Error")
010	Memory Error at xxxx:xxx:xxxh (R:xxxh, W:xxxh)
070	Real Time Clock Error
071	CMOS Battery Bad
072	CMOS Checksum Error
110	System disabled. Incorrect password is specified.
<No error code>	Battery critical LOW In this situation BIOS will issue 4 short beeps then shut down system, no message will show.
<No error code>	Thermal critical High In this situation BIOS will shut down system, not show message.

Error Message List

Error Messages	FRU/Action in Sequence
Failure Fixed Disk	Reconnect hard disk drive connector. "Load Default Settings" in BIOS Setup Utility. Hard disk drive System board
Stuck Key	see "Keyboard or Auxiliary Input Device Check" on page 73.
Keyboard error	see "Keyboard or Auxiliary Input Device Check" on page 73.
Keyboard Controller Failed	see "Keyboard or Auxiliary Input Device Check" on page 73.
Keyboard locked - Unlock key switch	Unlock external keyboard
Monitor type does not match CMOS - Run Setup	Run "Load Default Settings" in BIOS Setup Utility.
Shadow RAM Failed at offset: nnnn	BIOS ROM System board
System RAM Failed at offset: nnnn	DIMM System board
Extended RAM Failed at offset: nnnn	DIMM System board
System battery is dead - Replace and run Setup	Replace RTC battery and Run BIOS Setup Utility to reconfigure system time, then reboot system.
System CMOS checksum bad - Default configuration used	RTC battery Run BIOS Setup Utility to reconfigure system time, then reboot system.
System timer error	RTC battery Run BIOS Setup Utility to reconfigure system time, then reboot system. System board

Error Message List

Error Messages	FRU/Action in Sequence
Real time clock error	RTC battery Run BIOS Setup Utility to reconfigure system time, then reboot system. System board
Previous boot incomplete - Default configuration used	Run "Load Default Settings" in BIOS Setup Utility. RTC battery System board
Memory size found by POST differed from CMOS	Run "Load Default Settings" in BIOS Setup Utility. DIMM System board
Diskette drive A error	Check the drive is defined with the proper diskette type in BIOS Setup Utility See "External Diskette Drive Check" on page 73.
Incorrect Drive A type - run SETUP	Check the drive is defined with the proper diskette type in BIOS Setup Utility
System cache error - Cache disabled	System board
CPU ID:	System board
DMA Test Failed	DIMM System board
Software NMI Failed	DIMM System board
Fail-Safe Timer NMI Failed	DIMM System board
Device Address Conflict	Run "Load Default Settings" in BIOS Setup Utility. RTC battery System board
Allocation Error for device	Run "Load Default Settings" in BIOS Setup Utility. RTC battery System board
Failing Bits: nnnn	DIMM BIOS ROM System board
Fixed Disk n	None
Invalid System Configuration Data	BIOS ROM System board
I/O device IRQ conflict	Run "Load Default Settings" in BIOS Setup Utility. RTC battery System board
Operating system not found	Enter Setup and see if fixed disk and drive A: are properly identified. Diskette drive Hard disk drive System board

Error Message List

No beep Error Messages	FRU/Action in Sequence
No beep, power-on indicator turns off and LCD is blank.	Power source (battery pack and power adapter). See "Power System Check" on page 74. Ensure every connector is connected tightly and correctly. Reconnect the DIMM. LED board. System board.
No beep, power-on indicator turns on and LCD is blank.	Power source (battery pack and power adapter). See "Power System Check" on page 74. Reconnect the LCD connector Hard disk drive LCD inverter ID LCD cable LCD Inverter LCD System board
No beep, power-on indicator turns on and LCD is blank. But you can see POST on an external CRT.	Reconnect the LCD connectors. LCD inverter ID LCD cable LCD inverter LCD System board
No beep, power-on indicator turns on and a blinking cursor shown on LCD during POST.	Ensure every connector is connected tightly and correctly. System board
No beep during POST but system runs correctly.	Speaker System board

Phoenix BIOS Beep Codes

Code	Beeps	POST Routine Description
02h		Verify Real Mode
03h		Disable Non-Maskable Interrupt (NMI)
04h		Get CPU type
06h		Initialize system hardware
08h		Initialize chipset with initial POST values
09h		Set IN POST flag
0Ah		Initialize CPU registers
0Bh		Enable CPU cache
0Ch		Initialize caches to initial POST values
0Eh		Initialize I/O component
0Fh		Initialize the local bus IDE
10h		Initialize Power Management
11h		Load alternate registers with initial POST values
12h		Restore CPU control word during warm boot
13h		Initialize PCI Bus Mastering devices
14h		Initialize keyboard controller
16h	1-2-2-3	BIOS ROM checksum
17h		Initialize cache before memory autosize
18h		8254 timer initialization
1Ah		8237 DMA controller initialization
1Ch		Reset Programmable Interrupt Controller
20h	1-3-1-1	Test DRAM refresh
22h	1-3-1-3	Test 8742 Keyboard Controller
24h		Set ES segment register to 4 GB
26h		Enable A20 line
28h		Autosize DRAM
29h		Initialize POST Memory Manager
2Ah		Clear 215 KB base RAM
2Ch	1-3-4-1	RAM failure on address line xxxx
2Eh	1-3-4-3	RAM failure on data bits xxxx of low byte of memory bus
2Fh		Enable cache before system BIOS shadow
30h	1-4-1-1	RAM failure on data bits xxxx of high byte of memory bus
32h		Test CPU bus-clock frequency
33h		Initialize Phoenix Dispatch Manager
36h		Warm start shut down
38h		Shadow system BIOS ROM
3Ah		Autosize cache
3Ch		Advanced configuration of chipset registers
3Dh		Load alternate registers with CMOS values
42h		Initialize interrupt vectors
45h		POST device initialization
46h	2-1-2-3	Check ROM copyright notice

Code	Beeps	POST Routine Description
48h		Check video configuration against CMOS
49h		Initialize PCI bus and devices
4Ah		Initialize all video adapters in system
4Bh		QuietBoot start (optional)
4Ch		Shadow video BIOS ROM
4Eh		Display BIOS copyright notice
50h		Display CPU type and speed
51h		Initialize EISA board
52h		Test keyboard
54h		Set key click if enabled
58h	2-2-3-1	Test for unexpected interrupts
59h		Initialize POST display service
5Ah		Display prompt "Press F2 to enter SETUP"
5Bh		Disable CPU cache
5Ch		Test RAM between 512 and 640 KB
60h		Test extended memory
62h		Test extended memory address lines
64h		Jump to User Patch1
66h		Configure advanced cache registers
67h		Initialize Multi Processor APIC
68h		Enable external and CPU caches
69h		Setup System Management Mode (SMM) area
6Ah		Display external L2 cache size
6Bh		Load custom defaults (optional)
6Ch		Display shadow-area message
6Eh		Display possible high address for UMB recovery
70h		Display error messages
72h		Check for configuration errors
76h		Check for keyboard errors
7Ch		Set up hardware interrupt vectors
7Eh		Initialize coprocessor if present
80h		Disable onboard Super I/O ports and IRQs
81h		Late POST device initialization
82h		Detect and install external RS232 ports
83h		Configure non-MCD IDE controllers
84h		Detect and install external parallel ports
85h		Initialize PC-compatible PnP ISA devices
86h		Re-initialize onboard I/O ports
87h		Configure Motherboard Configurable Devices (optional)
88h		Initialize BIOS Area
89h		Enable Non-Maskable Interrupts (NMIs)
8Ah		Initialize Extended BIOS Data Area
8Bh		Test and initialize PS/2 mouse
8Ch		Initialize floppy controller

Code	Beeps	POST Routine Description
8Fh		Determine number of ATA drives (optional)
90h		Initialize hard-disk controllers
91h		Initialize local-bus hard-disk controllers
92h		Jump to UserPatch2
93h		Build MPTABLE for multi-processor boards
95h		Install CD ROM for boot
96h		Clear huge ES segment register
97h		Fixup Multi Processor table
98h	1-2	Search for option ROMs. One long, two short beeps on checksum failure.
99h		Check for SMART drive (optional)
9Ah		Shadow option ROMs
9Ch		Set up Power Management
9Dh		Initialize security engine (optional)
9Eh		Enable hardware interrupts
9Fh		Determine number of ATA and SCSI drives
A0h		Set time of day
A2h		Check key lock
A4h		Initialize Typematic rate
A8h		Erase F2 prompt
AAh		Scan for F2 key stroke
ACh		Enter SETUP
A Eh		Clear Boot flag
B0h		Check for errors
B2h		POST done- prepare to boot operating system
B4h	1	One short beep before boot
B5h		Terminate QuietBoot (optional)
B6h		Check password (optional)
B9h		Prepare Boot
BAh		Initialize DMI parameters
BBh		Initialize PnP Option ROMs
BCh		Clear parity checkers
BDh		Display MultiBoot menu
BEh		Clear screen (optional)
BFh		Check virus and backup reminders
C0h		Try to boot with INT 19
C1h		Initialize POST Error Manager (PEM)
C2h		Initialize error logging
C3h		Initialize error display function
C4h		Initialize system error handler
C5h		PnPnd dual CMOS (optional)
C6h		Initialize notebook docking (optional)
C7h		Initialize notebook docking late
C8h		Force check (optional)
C9h		Extended checksum (optional)
D2h		Unknown interrupt

Code	Beeps	
E0h		Initialize the chipset
E1h		Initialize the bridge
E2h		Initialize the CPU
E3h		Initialize the system timer
E4h		Initialize system I/O
E5h		Check force recovery boot
E6h		Checksum BIOS ROM
E7h		Go to BIOS
E8h		Set Huge Segment
E9h		Initialize Multi Processor
EAh		Initialize OEM special code
EBh		Initialize PIC and DMA
ECh		Initialize Memory type
EDh		Initialize Memory size
EEh		Shadow Boot Block
EFh		System memory test
F0h		Initialize interrupt vectors
F1h		Initialize Run Time Clock
F2h		Initialize video
F3h		Initialize System Management Mode
F4h	1	Output one beep before boot
F5h		Boot to Mini DOS
F6h		Clear Huge Segment
F7h		Boot to Full DOS

Index of Symptom-to-FRU Error Message

LCD-Related Symptoms

Symptom / Error	Action in Sequence
LCD backlight doesn't work LCD is too dark LCD brightness cannot be adjusted LCD contrast cannot be adjusted	Enter BIOS Utility to execute "Load Setup Default Settings", then reboot system. Reconnect the LCD connectors. Keyboard (if contrast and brightness function key doesn't work). LCD inverter ID LCD cable LCD inverter LCD System board
Unreadable LCD screen Missing pels in characters Abnormal screen Wrong color displayed	Reconnect the LCD connector LCD inverter ID LCD cable LCD inverter LCD System board
LCD has extra horizontal or vertical lines displayed.	LCD inverter ID LCD inverter LCD cable LCD System board

Indicator-Related Symptoms

Symptom / Error	Action in Sequence
Indicator incorrectly remains off or on, but system runs correctly	Reconnect the inverter board Inverter board System board

Power-Related Symptoms

Symptom / Error	Action in Sequence
Power shuts down during operation	Power source (battery pack and power adapter). See "Power System Check" on page 74. Battery pack Power adapter Hard drive & battery connection board System board
The system doesn't power-on.	Power source (battery pack and power adapter). See "Power System Check" on page 74. Battery pack Power adapter Hard drive & battery connection board System board
The system doesn't power-off.	Power source (battery pack and power adapter). See "Power System Check" on page 74. Hold and press the power switch for more than 4 seconds. System board
Battery can't be charged	See "Check the Battery Pack" on page 76. Battery pack System board

PCMCIA-Related Symptoms

Symptom / Error	Action in Sequence
System cannot detect the PC Card (PCMCIA)	PCMCIA slot assembly System board
PCMCIA slot pin is damaged.	PCMCIA slot assembly

Memory-Related Symptoms

Symptom / Error	Action in Sequence
Memory count (size) appears different from actual size.	Enter BIOS Setup Utility to execute "Load Default Settings, then reboot system. DIMM System board

Speaker-Related Symptoms

Symptom / Error	Action in Sequence
In Windows, multimedia programs, no sound comes from the computer.	Audio driver Speaker System board
Internal speakers make noise or emit no sound.	Speaker System board

Power Management-Related Symptoms

Symptom / Error	Action in Sequence
The system will not enter hibernation	Keyboard (if control is from the keyboard) Hard disk drive System board
The system doesn't enter hibernation mode and four short beeps every minute.	See "S4 Sleeping State" on page 36. Press Fn+F4 and see if the computer enters hibernation mode. Touchpad Keyboard Hard disk connection board Hard disk drive System board
The system doesn't enter standby mode after closing the LCD	See "S4 Sleeping State" on page 36. LCD cover switch System board
The system doesn't resume from hibernation mode.	See "S4 Sleeping State" on page 36. Hard disk connection board Hard disk drive System board
The system doesn't resume from standby mode after opening the LCD.	See "S4 Sleeping State" on page 36. LCD cover switch System board
Battery fuel gauge in Windows doesn't go higher than 90%.	Remove battery pack and let it cool for 2 hours. Refresh battery (continue use battery until power off, then charge battery). Battery pack System board

Power Management-Related Symptoms

Symptom / Error	Action in Sequence
System hangs intermittently.	Reconnect hard disk/CD-ROM drives. Hard disk connection board System board

Peripheral-Related Symptoms

Symptom / Error	Action in Sequence
System configuration does not match the installed devices.	Enter BIOS Setup Utility to execute "Load Default Settings", then reboot system. Reconnect hard disk/CD-ROM/diskette drives.
External display does not work correctly.	Press Fn+F5, LCD/CRT/Both display switching System board
USB does not work correctly	System board
Print problems.	Ensure the "Parallel Port" in the "Onboard Devices Configuration" of BIOS Setup Utility is set to Enabled. Onboard Devices Configuration Run printer self-test. Printer driver Printer cable Printer System Board
Serial or parallel port device problems.	Ensure the "Serial Port" in the Devices Configuration" of BIOS Setup Utility is set to Enabled. Device driver Device cable Device System board

Keyboard/Touchpad-Related Symptoms

Symptom / Error	Action in Sequence
Keyboard (one or more keys) does not work.	Reconnect the keyboard cable. Keyboard System board
Touchpad does not work.	Reconnect touchpad cable. Touchpad board System board

Modem-Related Symptoms

Symptom / Error	Action in Sequence
Internal modem does not work correctly.	Modem phone port modem combo board System board

NOTE: If you cannot find a symptom or an error in this list and the problem remains, see "Undetermined Problems" on page 89.

Intermittent Problems

Intermittent system hang problems can be caused by a variety of reasons that have nothing to do with a hardware defect, such as: cosmic radiation, electrostatic discharge, or software errors. FRU replacement should be considered only when a recurring problem exists.

When analyzing an intermittent problem, do the following:

1. Run the advanced diagnostic test for the system board in loop mode at least 10 times.
2. If no error is detected, do not replace any FRU.
3. If any error is detected, replace the FRU. Rerun the test to verify that there are no more errors.

Undetermined Problems

The diagnostic problems does not identify which adapter or device failed, which installed devices are incorrect, whether a short circuit is suspected, or whether the system is inoperative.

Follow these procedures to isolate the failing FRU (do not isolate non-defective FRU).

NOTE: Verify that all attached devices are supported by the computer.

NOTE: Verify that the power supply being used at the time of the failure is operating correctly. (See "Power System Check" on page 74):

1. Power-off the computer.
2. Visually check them for damage. If any problems are found, replace the FRU.
3. Remove or disconnect all of the following devices:
 - Non-Acer devices
 - Printer, mouse, and other external devices
 - Battery pack
 - Hard disk drive
 - DIMM
 - CD-ROM/Diskette drive Module
 - PC Cards
4. Power-on the computer.
5. Determine if the problem has changed.
6. If the problem does not recur, reconnect the removed devices one at a time until you find the failing FRU.
7. If the problem remains, replace the following FRU one at a time. Do not replace a non-defective FRU:
 - System board
 - LCD assembly

Jumper and Connector Locations

Top View

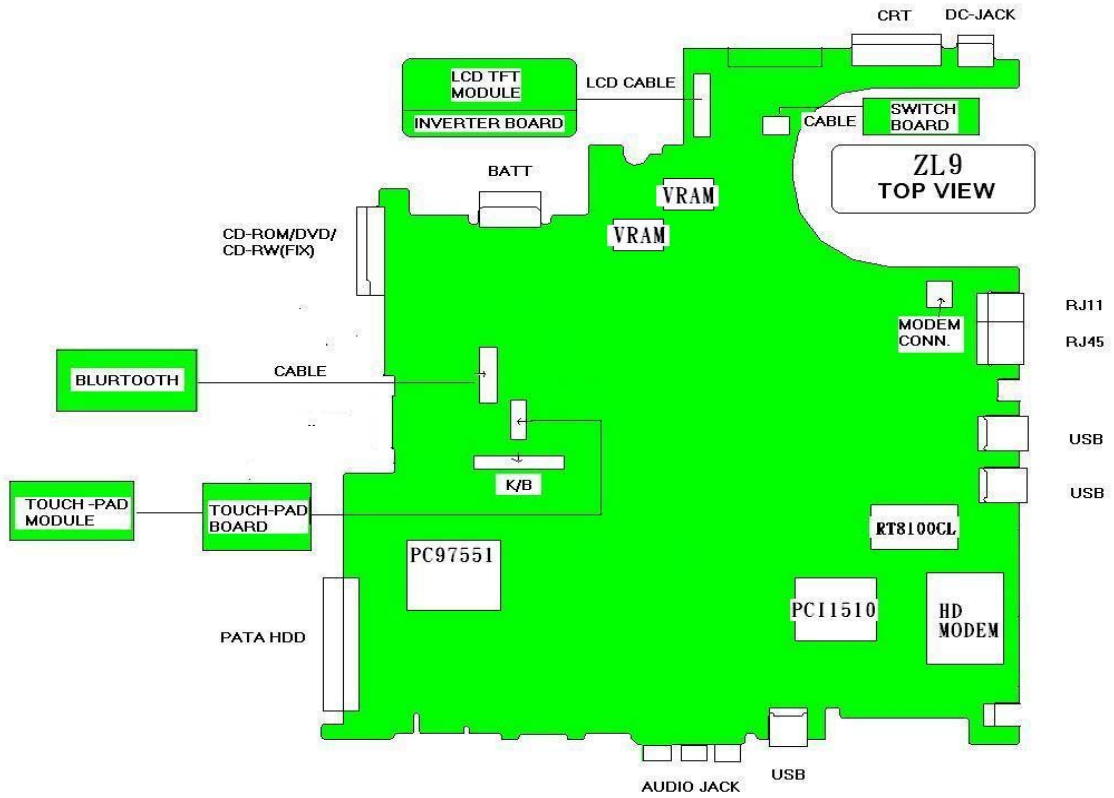

Bottom View

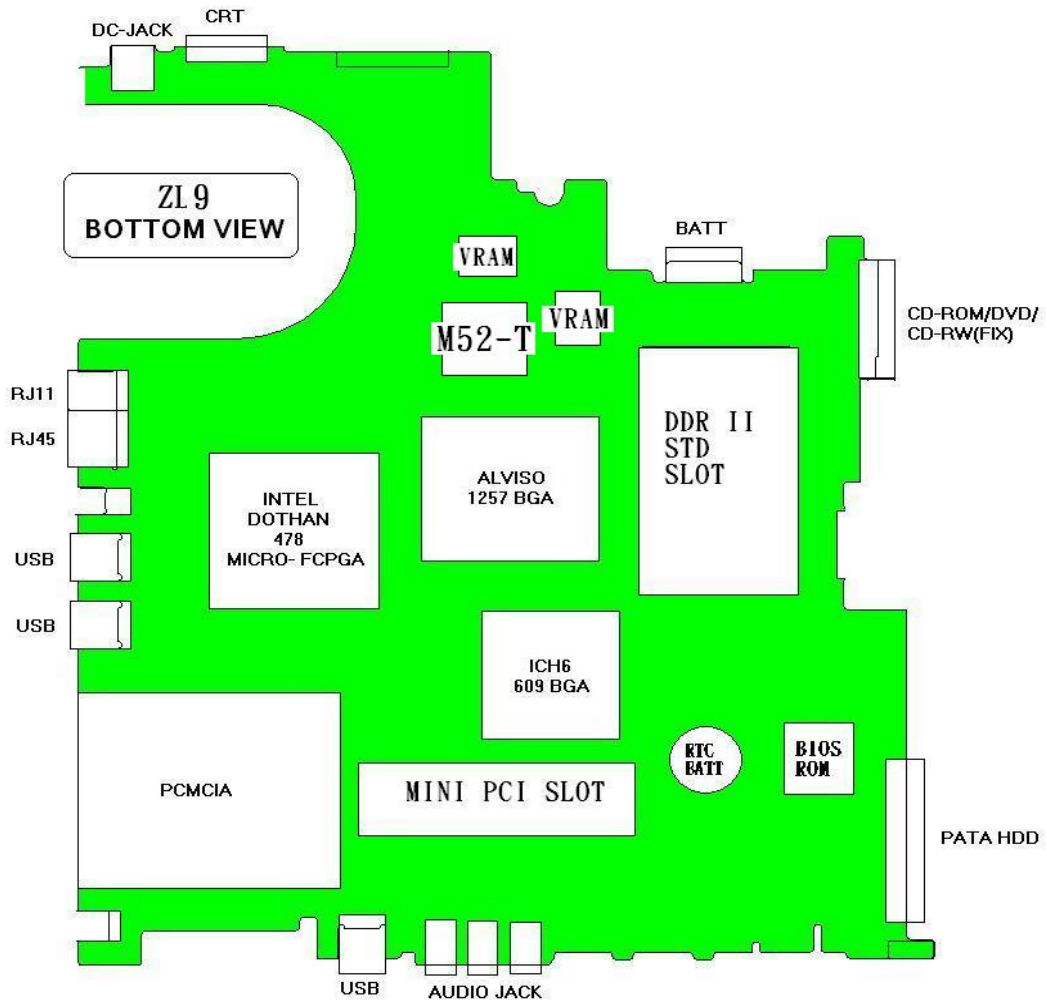

1	SW1	Lid Switch	2	CN1	LCD Connector
3	CN2	Launch Board Connector	4	CN3	Modem Connector
5	CN7	Keyboard Connector	6	CN4	Bluetooth Module Connector
7	CN5	Touchpad Board Connector	8	CN6	Internal Microphone Connector
9	U17	Clock Generator	10	U4	PCMCIA Connector
11	CN9	MDC Connector	12	CN11	Internal Speaker Connector
13	CN13	Power Jack	14	CN12	CRT Connector
15	CN14	Battery Connector	16	CN15	Optical Disk Drive Connector
17	CN17	RJ45 & RJ11 Connector	18	CN26	Wireless LAN Controller
19	U11	North Bridge	20	U13	CPU Socket
21	CN20	USB Connector	22	CN21	USB Connector
23	U19	BIOS ROM	24	U4	EC PC97551 (Power and I/O Connector)
25	CN22	RTC Battery	26	CN18	Memory Socket 1
27	U1	LAN Chipset RTL8100CL	28	CN19	Memory Socket 2

29	U18	South Bridge	30	CN24	PCMCIA Connector
31	CN25	HDD Connector	32	CN27	USB Connector
33	CN28	Line-out/SPEDIF Jack	34	CN29	Microphone Jack
35	CN30	Line-in Jack	36	SW3	WLAN Button
37	SW2	Bluetooth Button	38	LED2	Charger LED
39	LED1	Power LED	40	U22	Audio Codec
41	U10	Fan Connector			

FRU (Field Replaceable Unit) List

This chapter gives you the FRU (Field Replaceable Unit) listing in global configurations of TravelMate 4070/4080. Refer to this chapter whenever ordering for parts to repair or for RMA (Return Merchandise Authorization).

Please note that WHEN ORDERING FRU PARTS, you should check the most up-to-date information available on your regional web or channel. For whatever reasons a part number change is made, it will not be noted on the printed Service Guide. For ACER AUTHORIZED SERVICE PROVIDERS, your Acer office may have a DIFFERENT part number code from those given in the FRU list of this printed Service Guide. You MUST use the local FRU list provided by your regional Acer office to order FRU parts for repair and service of customer machines.

NOTE: To scrap or to return the defective parts, you should follow the local government ordinance or regulations on how to dispose it properly, or follow the rules set by your regional Acer office on how to return it.



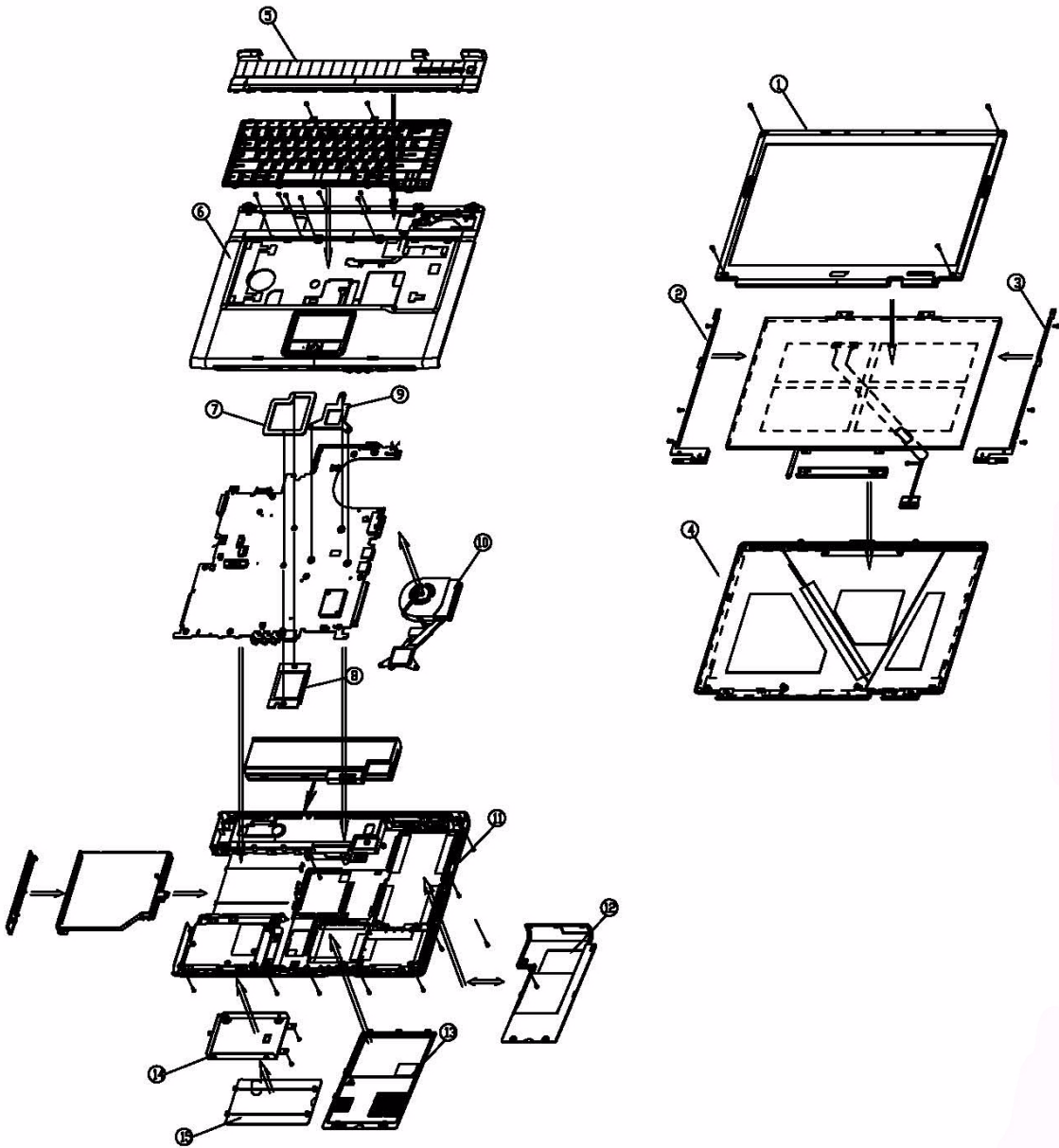



TravelMate 4070/4080 Exploded Diagram



TravelMate 4070/4080 FRU List

Adapter			
	NS	ADP 19V 3.42A PA-1650-02QR 90~264V LF	AP.06503.010
	NS	ADP 19V 3.42A SLS0335A19A57LF 90~264V EU	AP.06506.002
	NS	ADP 19V 3.42A SADP-65KB DBHF 90~264V LF	AP.06501.009
Battery			

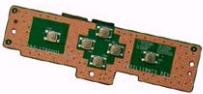





TravelMate 4070/4080 FRU List

	NS	BATTERY SANYO LI-ION 4S2P 4.4A 4UR18650F-2-QC140	BT.T5003.001
		BATTERY PANASONIC LI-ION 4S2P 4.4A CGR-B/8B5AE	BT.T5005.001
		BATTERY PANASONIC LI-ION 4S2P 4.4A ROHS	BT.00805.003
		BATTERY SIMPPLO PACK LI-ION 4S1P 2.0A	BT.00407.001
		BATTERY SANYO PACK LI-ION 4S1P 2.0A	BT.00403.004
		BATTERY SONY PACK LI-ION 4S1P 1.96A	BT.00404.004
Board			
	NS	MODEM 56K (MDC)T60M845.02 EU	54.TAKV7.001
	NS	BLUETOOTH MODULE W/ANTENNA	54.T48V7.001
	NS	W/L 802.11B/G(WM3B2200BGMW2)	KI.CAX01.008
	NS	LAUNCH BOARD	55.TAKV7.001
	NS	TOUCH PAD BOARD	55.TAKV7.002
Cable			
	NS	FFC CABLE - TP/B TO MB	50.T50V7.001

TravelMate 4070/4080 FRU List

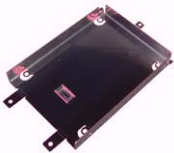
	NS	MODEM CABLE	50.A510V7.001
	NS	POWER CORD US (3 PIN)	27.A03V7.001
		POWER CORD PRC (3 PIN)	27.A03V7.003
		POWER CORD KOERA (Pin)	27.T23V7.006
		POWER CORD EU (3 PIN)	27.A03V7.002
		POWER CORD UK (3 PIN)	27.A03V7.004
		POWER CORD ITALIAN (3 PIN)	27.A03V7.005
		POWER CORD- SWISS	27.A03V7.007
		POWER CORD AU (3 PIN)	27.A03V7.008
		POWER CORD DANISH (3 PIN)	27.A03V7.006
		POWER CORD AF (3 PIN)	27.T48V7.001
Case/Cover/Bracket Assembly			
	5	MIDDEL COVER ERGO W/BUTTON - LIGHT GREEN SILVER	42.T50V7.101
	6	UPPER CASE W/TOUCHPAD, BRACKET, MIC, BLUETOOTH CABLE	60.T91V7.001
		UPPER CASE W/TOUCHPAD, BRACKET, MIC W/O BLUETOOTH CABLE	60.T91V7.002
	11	LOWER CASE W/SPEAKER	60.A51V7.002
	13	DIMM/WIRELESS COVER	42.A50V7.001
		HEATSINK COVER W/O DOCKING	42.A50V7.002

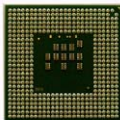
TravelMate 4070/4080 FRU List

	NS	3 IN 1 DUMMY COVER	42.T51V7.003
	15	HDD COVER	42.T63V7.004
	14	HDD BRACKET	33.T50V7.001
Communication Module			
	NS	WIRELESS LAN ANTENNA	50.T50V7.003
CPU/Processor			
	NS	AMD MOBILE SEMPRON 2800+ 25WD	KC.S2802.25D
		AMD MOBILE SEMPRON 3000+ 25WD	KC.S3002.25D
		AMD MOBILE TURION 64 ML28	KC.TML02.280
		AMD MOBILE TURION 64 ML30	KC.TML02.300
		AMD MOBILE TURION 64 ML32	KC.TML02.320
		AMD MOBILE TURION 64 ML34	KC.TML02.340
		AMD MOBILE TURION 64 ML37	KC.TML02.370
Optical Disk Drive Module			
	NS	DVD/CDRW COMBO MODULE 24X PHILIPS SCB5265 LF	6M.A65V7.004

TravelMate 4070/4080 FRU List

	NS	DVD/CDRW COMBO DRIVE 24X PHILIPS SCB5265 GB LF	KO.02403.007
	NS	OPTICAL DEVICE HOLDER-FIX	42.T51V7.003
	NS	DVD/CDRW BEZEL FOR G BASE	42.A65V7.003
		DVD/CDRW COMBO MODULE KME UJDA-770	6M.TAGV7.002
		DVD/CDRW COMBO DRIVE 24X KME UJDA-770	KO.02406.013
		OPTICAL DEVICE HOLDER-FIX	42.T51V7.003
		DVD/CDRW BEZEL FOR G BASE	42.A65V7.003
		DVD/CDRW COMBO MODULE LITE-ON SOSC-2483K LF	6M.ATKV7.001
		DVD/CDRW COMBO LITE-ON SOSC-2483K LF GB	KO.02409.011
		OPTICAL DEVICE HOLDER-FIX	42.T51V7.003
		DVD/CDRW BEZEL FOR G BASE	42.A65V7.003
		DVD/CDRW COMBO MODULE HLDS GCC-4244N LF	6M.ATKV7.002
		DVD/CDRW COMBO HLDS GCC-4244N GB LF	KO.0240A.004
		OPTICAL DEVICE HOLDER-FIX	42.T51V7.003
		DVD DUAL BEZEL G BASE	42.A65V7.003
		DVD DUAL MODULE PANASONIC UJ-840BAA2 G BASE	6M.A51V7.003
		DVD DUAL DRIVE PANASONIC UJ-840BAA2 D. LAYER G BASE	KU.00807.010
		OPTICAL DEVICE HOLDER-FIX	42.T51V7.003
		DVD DUAL BEZEL G BASE	42.A51V7.005
		DVD DUAL MODULE LITE-ON SOSW-833 DL G BASE	6M.T66V5.003

TravelMate 4070/4080 FRU List

		DVD DUAL DRIVE LIET-ON SOSW-833 DL G BASE	KU.00804.012
		OPTICAL DEVICE HOLDER-FIX	42.T51V7.003
		DVD DUAL BEZEL G BASE	42.A51V7.005
		DVD DUAL MODULE PIONEER DVR-K15RA F/W:1.05 G BASE	6M.ATKV7.003
		DVD DUAL DRIVEPIONEER DVR-K15RA D. LAYER F/W:1.05 G BASE	KU.00805.020
		OPTICAL DEVICE HOLDER-FIX	42.T51V7.003
		DVD DUAL BEZEL G BASE	42.A51V7.005
		DVD DUAL MODULE HLDS GWA-4082N G BASE	6M.ATKV7.004
		DVD DUAL DRIVE HLDS GWA-4082N G BASE	KU.0080D.016
		OPTICAL DEVICE HOLDER-FIX	42.T51V7.003
		DVD DUAL BEZEL G BASE	42.A51V7.005
HDD/Hard Disk Drive			
	NS	40G SEAGATE 2.5 IN. 4200RPM N2.1ST9402113A (ROHS), F/W 3.01	KH.04001.016
		40G TOSHIBA 2.5 IN. 4200RPM PLUTO MK4025GAS (ROHS) F/W KA100A	KH.04004.005
		40G HGST 2.5 IN. 4200RPM HAKONA-A F/W :A70G	KH.04007.013
		40G WD 2.5 IN. 5400RPM ML40 WD400UE-22HCT0 (ROHS)	KH.04008.025
		40G SAMSUNG 2.5 IN. 5400RPM M40MP0402H (ROHS) F/W YQ200-04	KH.0400B.003
		60G SEAGATE 2.5 IN. 4200RPM N2.2ST960812A F/W:3.04	KH.06001.003
		60G TOSHIBA 2.5 IN. 4200RPM PLUTO MK6025GAS (ROHS) F/W KA200	KH.06004.004
		60G HGST 2.5 IN. 4200RPM HAKONE-A F/W :A70G	KH.06007.009
		60G WD 2.5 IN. 5400RPM ML40 WD600UE-22HCT0 (ROHS)	KH.06008.002
		80G SEAGATE 2.5 IN. 4200RPM N2.2ST980829A F/W:3.04	KH.08001.013
		80G TOSHIBA 2.5 IN. 4200RPM PLUTO MK8025GAS (ROHS) F/W KA023	KH.08004.003



TravelMate 4070/4080 FRU List

		80G HGST 2.5 IN. 4200RPM HAKONE-A F/W:A70G	KH.08007.011
		80G WD 2.5 IN. 5400RPM ML40 WD800UE-22HCT0 (ROHS)	KH.08008.027
		100G TOSHIBA 2.5 IN. 4200RPM ARES MK1031GAS (ROHS) F/W AA204A	KH.10004.001
		100G HGST 2.5 IN. 4200RPM HAKONE-A F/W:A70G	KH.10007.002
Keyboard			
	NS	AS1680/AS1410 KEYBOARD DARFON US International	KB.A2707.001
		AS1680/AS1410 KEYBOARD DARFON Chinese	KB.A2707.002
		AS1680/AS1410 KEYBOARD DARFON Spanish	KB.A2707.003
		AS1680/AS1410 KEYBOARD DARFON Thai	KB.A2707.004
		AS1680/AS1410 KEYBOARD DARFON Brazilian Protugese	KB.A2707.005
		AS1680/AS1410 KEYBOARD DARFON Korea	KB.A2707.006
		AS1680/AS1410 KEYBOARD DARFON UK	KB.A2707.007
		AS1680/AS1410 KEYBOARD DARFON German	KB.A2707.008
		AS1680/AS1410 KEYBOARD DARFON Italian	KB.A2707.009
		AS1680/AS1410 KEYBOARD DARFON French	KB.A2707.010
		AS1680/AS1410 KEYBOARD DARFON Swiss/G	KB.A2707.011
		AS1680/AS1410 KEYBOARD DARFON Portuguese	KB.A2707.012
		AS1680/AS1410 KEYBOARD DARFON Arabic	KB.A2707.013
		AS1680/AS1410 KEYBOARD DARFON Belgium	KB.A2707.014
		AS1680/AS1410 KEYBOARD DARFON Sweden	KB.A2707.015
		AS1680/AS1410 KEYBOARD DARFON Czech	KB.A2707.016
		AS1680/AS1410 KEYBOARD DARFON Hungaian	KB.A2707.017
		AS1680/AS1410 KEYBOARD DARFON Norway	KB.A2707.018
		AS1680/AS1410 KEYBOARD DARFON Danish	KB.A2707.019
		AS1680/AS1410 KEYBOARD DARFON Turkish	KB.A2707.020

TravelMate 4070/4080 FRU List

		AS1680/AS1410 KEYBOARD DARFON Canadian French	KB.A2707.021
		AS1680/AS1410 KEYBOARD DARFON Japanese	KB.A2707.022
		AS1680/AS1410 KEYBOARD DARFON Greek	KB.A2707.023
		AS1680/AS1410 KEYBOARD DARFON Hebrew	KB.A2707.024
		AS1680/AS1410 KEYBOARD DARFON Russian	KB.A2707.025
LCD Module			
	NS	LCD 15.0 IN. MODULE SAMSUNG LTN150XB-L03-V LF	6M.ATKV7.011
	NS	LCD 15.0 IN. XGA SAMSUNG LTN150XB-L03-V LF	LK.15006.008
	NS	LCD INVERTER BOARD	19.TAKV7.001
	NS	LCD CABLE - 15 IN. XGA	50.T50V7.004
	NS	LCD BRACKET W/HINGE 15 IN. - L	33.T50V7.002

TravelMate 4070/4080 FRU List

	NS	LCD BRACKET W/HINGE 15 IN. - R	33.T50V7.003
	NS	LCD PANEL W/LOGO ANTENNA 14/15 IN.	60.T50V7.102
	NS	LCD BEZEL W/RUBBER PAD 15 IN.	60.T50V7.004
		LCD 15.0 IN. MODULE CMO N150X3-L07 LF	6M.ATKV7.012
		LCD 15.0 IN. XGA CMO N150X3-L07 REV C4 LF	LK.1500D.012
	NS	LCD INVERTER BOARD	19.TAKV7.001
	NS	LCD CABLE - 15 IN. XGA	50.T50V7.004
	NS	LCD BRACKET W/HINGE 15 IN. - L	33.T50V7.002
	NS	LCD BRACKET W/HINGE 15 IN. - R	33.T50V7.003
	NS	LCD PANEL W/LOGO ANTENNA 14/15 IN.	60.T50V7.102
	NS	LCD BEZEL W/RUBBER PAD 15 IN.	60.T50V7.004
		LCD 15.0 IN. MODULE LPL LP150X07-TLA2 LF	6M.ATKV7.013
		LCD 15.0 IN. XGA LPL LP150X07-TLA2 LF	LK.15008.019
	NS	LCD INVERTER BOARD	19.TAKV7.001
	NS	LCD CABLE - 15 IN. XGA	50.T50V7.004
	NS	LCD BRACKET W/HINGE 15 IN. - L	33.T50V7.002
	NS	LCD BRACKET W/HINGE 15 IN. - R	33.T50V7.003
	NS	LCD PANEL W/LOGO ANTENNA 14/15 IN.	60.T50V7.102
	NS	LCD BEZEL W/RUBBER PAD 15 IN.	60.T50V7.004
		LCD 15.0 IN. MODULE LPL LP150X07-TLA2 LF	6M.ATKV7.013



TravelMate 4070/4080 FRU List

		LCD 15.0 IN. XGA LPL LP150X07-TLA2 LF	LK.15008.019
		LCD INVERTER BOARD	19.TAKV7.001
		LCD CABLE - 15 IN. XGA	50.T50V7.004
		LCD BRACKET W/HINGE 15 IN. - L	33.T50V7.002
		LCD BRACKET W/HINGE 15 IN. - R	33.T50V7.003
		LCD PANEL W/LOGO ANTENNA 14/15 IN.	60.T50V7.102
		LCD BEZEL W/RUBBER PAD 15 IN.	60.T50V7.004
	NS	LCD MODULE 15.4 IN. WXGA CMO N15411-L09	6M.A51V7.013
	NS	LCD 15.4 IN. WXGA CMO N15411-L09	LK.1540D.002
	NS	LCD INVERTER BOARD	19.TAKV7.001
	NS	LCD CABLE - 15.4 IN. XGA	50.T50V7.006
	2	LCD BRACKET W/HINGE 15.4 IN. - L	33.T50V7.004
	3	LCD BRACKET W/HINGE 15.4 IN. - R	33.T50V7.005
	4	LCD PANEL W/LOGO ANTENNA 14/15 IN.	60.T50V7.102
	1	LCD BEZEL W/RUBBER PAD 15.4 IN.	60.T50V7.006
		LCD 15.4 MODULE SAMSUNG LTN154X3-L01-V104	6M.ATKV7.014
		LCD 15.4 WXGA SAMSUNG LTN154X3-L01-V104	LK.15406.009
		LCD INVERTER BOARD	19.TAKV7.001
		LCD CABLE - 15.4 IN. WXGA	50.T50V7.006
		LCD BRACKET W/HINGE 15.4 IN. - L	33.T50V7.004
		LCD BRACKET W/HINGE 15.4 IN. - R	33.T50V7.005
		LCD PANEL W/LOGO ANTENNA 15.4 IN.	60.T50V7.103
		LCD BEZEL W/RUBBER PAD 15.4 IN.	60.T50V7.006
		LCD 15.4 MODULE QDI QD15TL02-03 LF NON-GLARE	6M.ATKV7.015
		LCD 15.4 WXGA QDI QD15TL02-03 LF NON-GLARE	LK.15409.004
		LCD INVERTER BOARD	19.TAKV7.014
		LCD CABLE - 15.4 IN. WXGA	50.T50V7.006
		LCD BRACKET W/HINGE 15.4 IN. - L	33.T50V7.004
		LCD BRACKET W/HINGE 15.4 IN. - R	33.T50V7.005
		LCD PANEL W/LOGO ANTENNA 15.4 IN.	60.T50V7.103
		LCD BEZEL W/RUBBER PAD 15.4 IN.	60.T50V7.006
		LCD 15.4 IN. MODULE AU B154EW01 V8 LF NON-G	6M.ATKV7.016

TravelMate 4070/4080 FRU List

		LCD 15.4 IN. WXGA AU B154EW01 V8 LF NON-G	LK.15405.005
		LCD INVERTER BOARD	19.TAKV7.001
		LCD CABLE - 15.4 IN. WXGA	50.T50V7.006
		LCD BRACKET W/HINGE 15.4 IN. - L	33.T50V7.004
		LCD BRACKET W/HINGE 15.4 IN. - R	33.T50V7.005
		LCD PANEL W/LOGO ANTENNA 15.4 IN.	60.T50V7.103
		LCD BEZEL W/RUBBER PAD 15.4 IN.	60.T50V7.006
		LCD 15.0 IN. MODULE SAMSUNG LTN150XB-L03-V W/O WIRELESS	6M.ATKV7.021
		LCD 15.0 IN. XGA SAMSUNG LTN150XB-L03-V LF	LK.15006.008
		LCD INVERTER BOARD	19.TAKV7.001
		LCD CABLE - 15 IN. XGA	50.T50V7.004
		LCD BRACKET W/HINGE 15 IN. - L	33.T50V7.002
		LCD BRACKET W/HINGE 15 IN. - R	33.T50V7.003
		LCD PANEL W/LOGO W/O ANTENNA 14/15 IN.	60.T56V7.102
		LCD BEZEL W/RUBBER PAD 15 IN.	60.T50V7.004
		LCD 15.0 IN. MODULE CMO N150X3- L07 LF W/O WIRELESS	6M.ATKV7.022
		LCD 15.0 IN. XGA CMO N150X3-L07 REV C4 LF	LK.1500D.012
		LCD INVERTER BOARD	19.TAKV7.001
		LCD CABLE - 15 IN. XGA	50.T50V7.004
		LCD BRACKET W/HINGE 15 IN. - L	33.T50V7.002
		LCD BRACKET W/HINGE 15 IN. - R	33.T50V7.003
		LCD PANEL W/LOGO W/O ANTENNA 14/15 IN.	60.A56V7.102
		LCD BEZEL W/RUBBER PAD 15 IN.	60.T50V7.004
		LCD 15.0 IN. MODULE LPL LP150X07-TLA2 LF W/O WIRELESS	6M.ATKV7.023
		LCD 15.0 IN. XGA LPL LP150X07- TLA2 LF	LK.15008.019
		LCD INVERTER BOARD	19.TAKV7.001
		LCD CABLE - 15 IN. XGA	50.T50V7.004
		LCD BRACKET W/HINGE 15 IN. - L	33.T50V7.002
		LCD BRACKET W/HINGE 15 IN. - R	33.T50V7.003
		LCD PANEL W/LOGO W/O ANTENNA 14/15 IN.	60.A56V7.102
		LCD BEZEL W/RUBBER PAD 15 IN.	60.T50V7.004
		LCD 15.4 MODULE QDI QD15TL02- 03 LF NON-GLARE W/O WIRELESS	6M.ATKV7.025

TravelMate 4070/4080 FRU List

		LCD 15.4 WXGA QDI QD15TL02-03 LF NON-GLARE	LK.15409.004
		LCD INVERTER BOARD	19.TAKV7.001
		LCD CABLE - 15.4 IN. WXGA	50.T50V7.006
		LCD BRACKET W/HINGE 15.4 IN. - L	33.T50V7.004
		LCD BRACKET W/HINGE 15.4 IN. - R	33.T50V7.005
		LCD PANEL W/LOGO ANTENNA 15.4 IN.	60.T56V7.103
		LCD BEZEL W/RUBBER PAD 15.4 IN.	60.T50V7.006
		LCD 15.4 IN. MODULE AU B154EW01 V8 LF NON-G W/O WIRELESS	6M.ATKV7.026
		LCD 15.4 IN. WXGA AU B154EW01 V8 LF NON-G	LK.15405.005
		LCD INVERTER BOARD	19.TAKV7.001
		LCD CABLE - 15.4 IN. WXGA	50.T50V7.006
		LCD BRACKET W/HINGE 15.4 IN. - L	33.T50V7.004
		LCD BRACKET W/HINGE 15.4 IN. - R	33.T50V7.005
		LCD PANEL W/LOGO ANTENNA 15.4 IN.	60.T56V7.103
		LCD BEZEL W/RUBBER PAD 15.4 IN.	60.T50V7.006
Main Board			
	NS	MAINBOARD 915GM UMA W/ PCMCIA W/O CPU MEMORY	LB.TAK02.001
Memory			
	NS	MEMORY DDR333 256MB INFINEON HYS64D32020HDL-6-C (.11u)	KN.25602.012
		MEMORY DDR333 256MB NANYA NT256D64SH8COGM-6K	KN.25603.019
		MEMORY DDR333 256MB SAMSUNG M470L3224FT0-CB3	KN.2560B.008
		MEMORY DDR333 256MB HYNIX HYMD232M646D6-J	KN.2560G.001
		MEMORY DDR333 512MB INFINEON HYS64D64020HBDL-6-C (.11u)	KN.51202.025
		MEMORY DDR333 512MB SAMSUNG M470L6524BT0-CB3	KN.5120B.006
		MEMORY DDR333 256MB HYNIX HYMD564M646B6-J	KN.5120G.006
Speaker			

TravelMate 4070/4080 FRU List

	N/S	SPEAKER SET	23.T50V7.001
Heatsink			
	10	THERMAL MODULE	60.A51V7.005
Miscellaneous			
	NS	NAME PLATE - TM4060	1HYXZZZ24H9
	NS	RUBBER FOOT	1HYXZZZ24D6
	NS	LCD SCREW RUBBER PAD	47.T50V7.003
	NS	LCD BEZEL RUBBER PAD	47.T50V7.004
Screw			
	NS	SCREW M2.0X3.0-I-NI-NYLOK	86.A03V7.012
	NS	SCREW I2.5*3M-BNIH(M2.5L3)	86.T25V7.012
	NS	SCREW M2.5*4L-BZN-NYLOK	86.A03V7.006
	NS	SCREW M2.0X5-I-NI-NYLOK	86.T23V7.006
	NS	SCREW MM25060IL69	86.A08V7.004
	NS	SCREW M2.0*5-I(NI)(NYLOK)	86.T23V7.010
	NS	SCREW M2.0X2.5-I-NI-NYLOK	86.A03V7.007
	NS	SCREW I2*3M-NIHY (M2L3)	86.T25V7.008
	NS	SCREW M1.7*3.0-I (BK)	86.T50V7.001
	NS	SCREW I3*3.5M-NIH(M3L3.5)	86.A03V7.011

