

# **Aspire 7736/7736Z/7336 Series Aspire 7540 Series Service Guide**

Service guide files and updates are available on the ACER/CSD web; for more information, please refer to <http://csd.acer.com.tw>

PRINTED IN TAIWAN

---

# Revision History

Please refer to the table below for the updates made on Aspire 7736/7736Z/7336 and Aspire 7540 Series service guide.

Date	Chapter	Updates

---

## Copyright

Copyright © 2009 by Acer Incorporated. All rights reserved. No part of this publication may be reproduced, transmitted, transcribed, stored in a retrieval system, or translated into any language or computer language, in any form or by any means, electronic, mechanical, magnetic, optical, chemical, manual or otherwise, without the prior written permission of Acer Incorporated.

## Disclaimer

The information in this guide is subject to change without notice.

Acer Incorporated makes no representations or warranties, either expressed or implied, with respect to the contents hereof and specifically disclaims any warranties of merchantability or fitness for any particular purpose. Any Acer Incorporated software described in this manual is sold or licensed "as is". Should the programs prove defective following their purchase, the buyer (and not Acer Incorporated, its distributor, or its dealer) assumes the entire cost of all necessary servicing, repair, and any incidental or consequential damages resulting from any defect in the software.

Acer is a registered trademark of Acer Corporation.

Intel is a registered trademark of Intel Corporation.

Other brand and product names are trademarks and/or registered trademarks of their respective holders.

---

## Conventions

The following conventions are used in this manual:

<b>SCREEN MESSAGES</b>	Denotes actual messages that appear on screen.
<b>NOTE</b>	Gives bits and pieces of additional information related to the current topic.
<b>WARNING</b>	Alerts you to any damage that might result from doing or not doing specific actions.
<b>CAUTION</b>	Gives precautionary measures to avoid possible hardware or software problems.
<b>IMPORTANT</b>	Reminds you to do specific actions relevant to the accomplishment of procedures.

---

## Preface

Before using this information and the product it supports, please read the following general information.

1. This Service Guide provides you with all technical information relating to the BASIC CONFIGURATION decided for Acer's "global" product offering. To better fit local market requirements and enhance product competitiveness, your regional office MAY have decided to extend the functionality of a machine (e.g. add-on card, modem, or extra memory capability). These LOCALIZED FEATURES will NOT be covered in this generic service guide. In such cases, please contact your regional offices or the responsible personnel/channel to provide you with further technical details.
2. Please note WHEN ORDERING FRU PARTS, that you should check the most up-to-date information available on your regional web or channel. If, for whatever reason, a part number change is made, it will not be noted in the printed Service Guide. For ACER-AUTHORIZED SERVICE PROVIDERS, your Acer office may have a DIFFERENT part number code to those given in the FRU list of this printed Service Guide. You MUST use the list provided by your regional Acer office to order FRU parts for repair and service of customer machines.



<b>System Specifications</b>	<b>1</b>
Features	1
System Block Diagram	4
Your Acer Notebook tour	6
Right View	9
Indicators	10
Easy-Launch Buttons	11
Touchpad Basics (with fingerprint reader)	11
Touchpad basics (with two-click buttons)	12
Using the Keyboard	13
Lock Keys and numeric keypad	13
Windows Keys	14
Hot Keys	15
Special Key (only for certain models)	15
Windows Mobility Center	16
Using the System Utilities	17
Acer Bio-Protection (only for certain models)	17
Acer GridVista (dual-display compatible)	18
Hardware Specifications and Configurations	19
 <b>System Utilities</b>	 <b>27</b>
BIOS Setup Utility	27
Navigating the BIOS Utility	28
Information	29
Main	31
Security	33
Boot	37
Exit	38
BIOS Flash Utility	39
Remove HDD Password	40
 <b>Machine Disassembly and Replacement</b>	 <b>41</b>
Disassembly Requirements	41
General Information	42
Pre-disassembly Instructions	42
Disassembly Process	42
External Module Disassembly Process	43
External Modules Disassembly Flowchart	43
Removing the SD Dummy Card	44
Removing the Battery Pack	45
Removing the Back Cover	46
Removing the Hard Disk Drive Module	48
Removing the Wireless LAN Card	50
Removing the DIMM Module	51
Removing the Heatsink Module	52
Removing the CPU	54
Removing the Optical Drive Module	55
Main Unit Disassembly Process	57
Main Unit Disassembly Flowchart	57
Removing the Middle Cover	58
Removing the Keyboard	60
Removing the LCD Module	61
Separating the Upper Case from the Lower Case	63
Removing the Fingerprint/Button and Touchpad Boards	66

# Table of Contents

Removing the USB Board Module .....	69
Removing the Modem Board .....	71
Removing the Bluetooth Board .....	72
Removing the Microphone Module .....	74
Removing the Main Board .....	75
LCD Module Disassembly Process .....	77
LCD Module Disassembly Flowchart .....	77
Removing the LCD Bezel .....	78
Removing the LCD panel with the Brackets .....	79
Removing the LCD Brackets .....	81
Removing the Web Camera .....	81
Removing the FPC Cable .....	82
Removing the Antennas .....	84
<b>Troubleshooting</b> .....	<b>85</b>
System Check Procedures .....	86
External Diskette Drive Check .....	86
External Optical Disk Drive Check .....	86
Keyboard or Auxiliary Input Device Check .....	86
Memory Check .....	87
Power System Check .....	87
Touchpad Check .....	88
Power-On Self-Test (POST) Error Message .....	88
Index of Error Messages .....	89
Phoenix BIOS Beep Codes .....	93
Index of Symptom-to-FRU Error Message .....	97
Intermittent Problems .....	101
Undetermined Problems .....	102
<b>Connector Locations</b> .....	<b>103</b>
Main Board .....	103
Clearing Password Check and BIOS Recovery .....	105
Clearing Password Check .....	105
BIOS Recovery by Crisis Disk .....	107
<b>FRU (Field Replaceable Unit) List</b> .....	<b>111</b>
Aspire 7736/7736Z/7336 Series and Aspire 7540 Series Exploded Diagram .....	112
<b>Model Definition and Configuration</b> .....	<b>143</b>
Aspire 7736/7736Z/7336 Series .....	144
<b>Test Compatible Components</b> .....	<b>171</b>
Microsoft® Windows® Vista Environment Test .....	172
<b>Online Support Information</b> .....	<b>175</b>
<b>Index</b> .....	<b>177</b>



# System Specifications

---

## Features

Below is a brief summary of the computer's many features:

### Platform

For Aspire 7736/7736Z/7336 Series

- Intel® Centrino® 2 processor technology, featuring:
  - Intel® Core™ 2 Duo processor
  - Intel Celeron processor
  - Mobile Intel® PM45/GM45/GL40 Express Chipset\*
  - Intel® Wireless WiFi Link 5100/5300\*
- Intel® Pentium® mobile processor\*
- Mobile Intel® GM45/GL40 Express Chipset\*
- Acer InviLink™ Nplify™ 802.11b/g/Draft-N\*
- Acer InviLink™ 802.11b/g\*

For Aspire 7540 Series

- AMD Better By Design Program, featuring:
  - AMD Turion™ II Ultra dual-core processor\*
  - AMD Turion™ II dual-core processor\*
  - AMD Athlon™ 64 II dual-core processor\*
  - AMD M880G Chipset
  - Acer InviLink™ Nplify™ 802.11b/g/Draft-N\*
  - Acer InviLink™ 802.11b/g\*

### System Memory

- Dual-channel SDRAM support
- Up to 2 GB of DDR2 667 MHz memory, upgradeable to 4 GB using two soDIMM modules

### Display and graphics

- 16:9 aspect ratio
- 17.3" HD+ 1600 x 900

For Aspire 7736/7736Z/7336 Series

- Mobile Intel® GL40 Express Chipset
- Mobile Intel® GM45 Express Chipset\*
- NVIDIA® GeForce® G210M\*

For Aspire 7540 Series

- ATI Mobility Radeon™ HD 4570\*
- ATI Radeon™ HD 4200 Graphics\*

- 
- Screen resolution support  
For UMA models: 640x480, 720x480, 800x480, 800x600, 1024x480, 1024x600, 1024x768, 1152x864, 1280x600, 1280x720, 1280x768, 1600x900
  - For Discrete models: 800x600, 1024x768, 1152x862, 1280x720, 1280x768, 1280\*800, 1360\*768, 1600x900

## Storage subsystem

- 2.5" hard disk drive
- Optical drive options:
  - Blu-ray Disc™/DVD-Super Multi double-layer drive\*
  - DVD-Super Multi double-layer drive\*
- Multi-in-1 card reader

## Special keys and controls

- 103-/104-/107-key keyboard
- Touchpad pointing device

## Audio

- Dolby®-optimized surround sound system with two built-in stereo speakers
- True 5.1-channel surround sound output
- High-definition audio support
- S/PDIF (Sony/Philips Digital Interface) support for digital speakers
- MS-Sound compatible
- Built-in microphone

## Communication

- Integrated Acer Crystal Eye webcam\*
- WLAN:
  - Intel® Wireless WiFi Link 5100/5300 (For Aspire 7736/7736Z/7336 Series)
  - Acer InviLink™ Nplify™ 802.11b/g/Draft-N\*
  - Acer InviLink™ 802.11b/g\*
- WPAN: Bluetooth® 2.1+Enhanced Data Rate (EDR)\*
- LAN: Gigabit Ethernet; Wake-on-LAN ready
- Modem: 56K ITU V.92; Wake-on-Ring ready

## I/O Ports

- Acer Bio-Protection fingerprint reader\* (For Aspire 7736/7736Z/7336 Series)
- Multi-in-1 card reader (SD/MMC/MS/MS PRO/xD)
- USB 2.0 port
- HDMI™ port with HDCP support
- External display (VGA) port
- Headphones/speaker/line-out jack with S/PDIF support
- Microphone-in jack
- Line-in jack
- Ethernet (RJ-45) port

- 
- Modem (RJ-11) port
  - DC-in jack for AC adapter

## Environment

- Temperature:
  - Operating: 5 °C to 35 °C
  - Non-operating: -20 °C to 65 °C
- Humidity (non-condensing):
  - Operating: 20% to 80%
  - Non-operating: 20% to 80%

## Dimension and weight

- Dimension: 411 (W) x 274 (D) x 40/45.0 (H) mm
- Weight: <3.3kg

**NOTE:** 1. "\*" means only for certain models".

2. The specifications listed above are for reference only. The exact configuration of your PC depends on the model purchased.

# System Block Diagram

For Aspire 7736/7736Z/7336 Series:

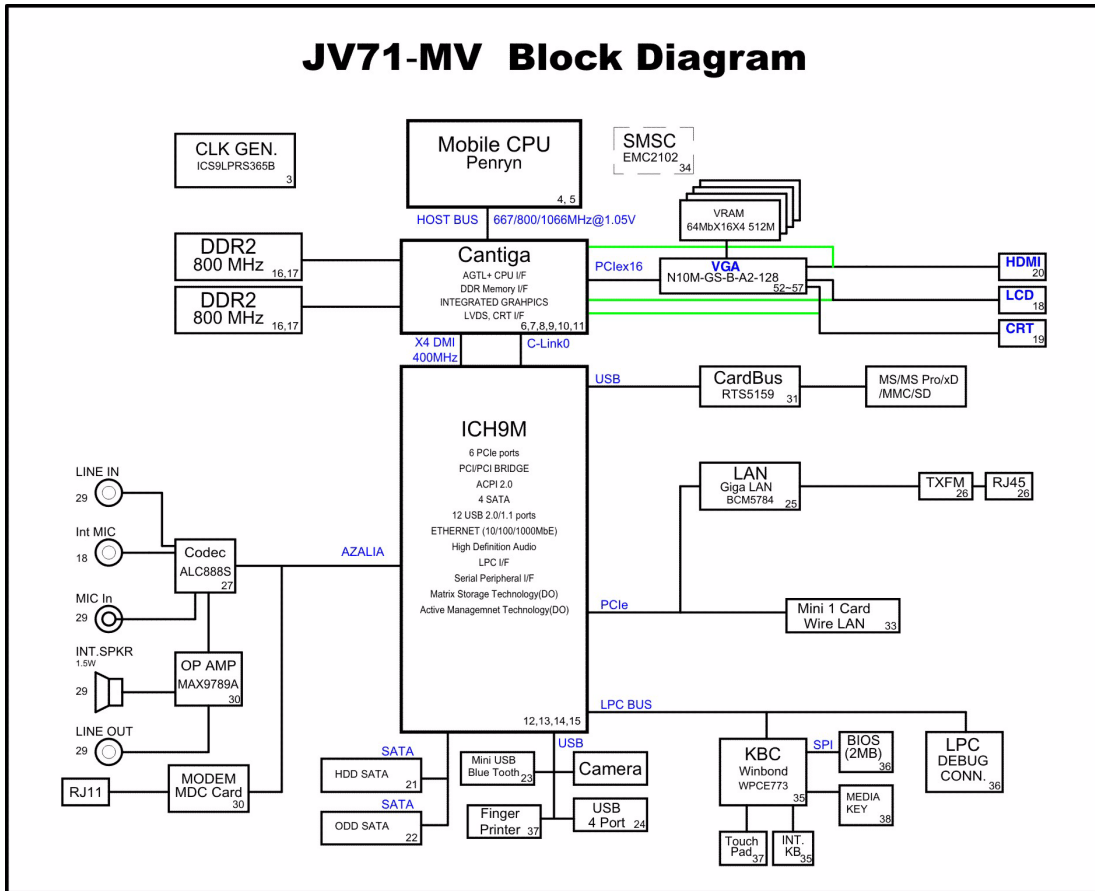

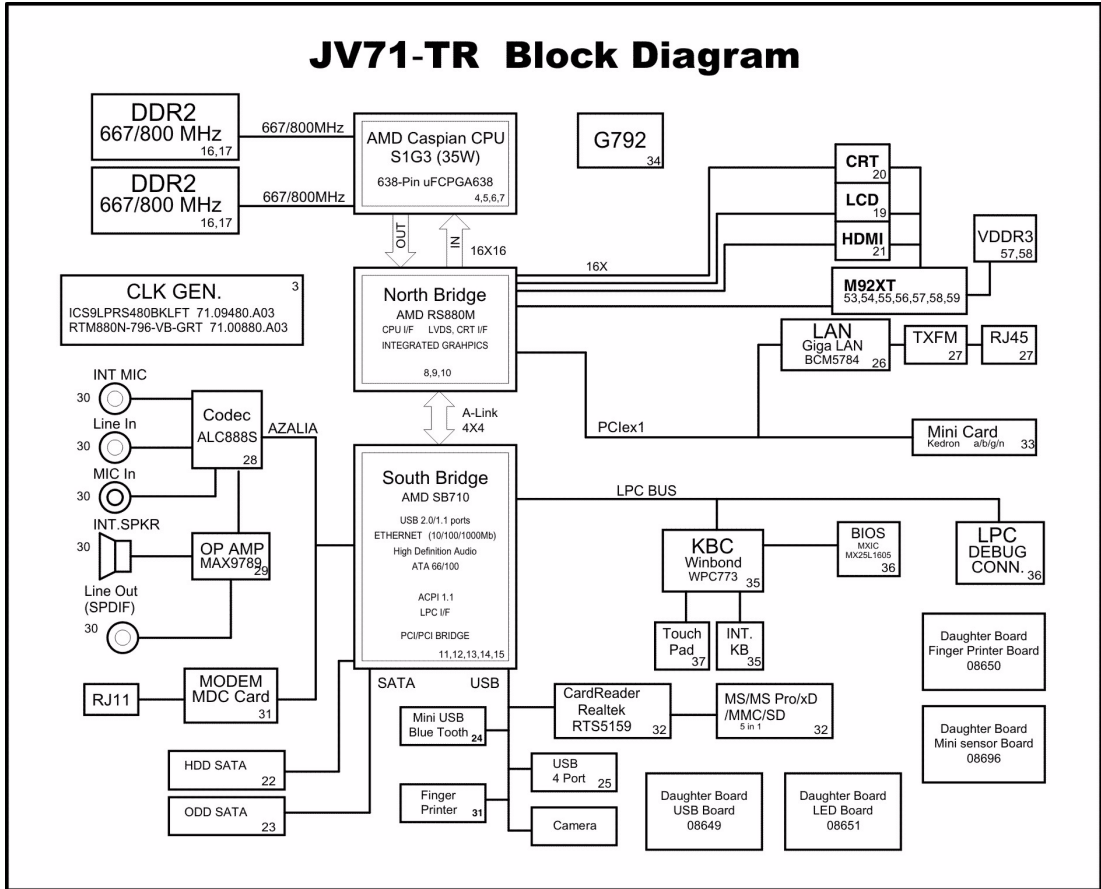











# Your Acer Notebook tour

After knowing your computer features, let us show you around your new computer.

## Front View



#	Icon	Item	Description
1		Acer Crystal Eye webcam	Web camera for video communication. (only for certain models)
2		Display screen	Also called Liquid-Crystal Display (LCD), displays computer output (Configuration may vary by models).
3	⏻	Power button	Turns the computer on and off.

#	Icon	Item	Description
4		Wireless LAN communication button/indicator	Enables/disables the wireless LAN function. Indicates the status of wireless LAN communication.
		Bluetooth communication button/indicator	Enables/disables the Bluetooth function. Indicates the status of Bluetooth communication. (only for certain models)
		Backup key	Launches Acer Backup Management for three-step data backup.
		HDD	Indicates when the hard disk drive is active.
		Num Lock	Lights up when Num Lock is activated.
		Caps Lock	Lights up when Caps Lock is activated.
5		Keyboard	For entering data into your computer.
6		Touchpad	Touch-sensitive pointing device which functions like a computer mouse.
7		Power <sup>1</sup>	Indicates the computer's power status.
		Battery <sup>1</sup>	Indicates the computer's battery status. <b>1. Charging:</b> The light shows amber when the battery is charging. <b>2. Fully charged:</b> The light shows blue when in AC mode.
8		Click buttons (left and right)	The left and right buttons function like the left and right mouse buttons.
9		Palmrest	Comfortable support area for your hands when you use the computer.
10		Touchpad toggle	Turns the internal touchpad on and off.
11		Microphone	Internal microphone for sound recording.
12		Acer PowerSmart key	Puts your computer into power-saving mode.
13		Speakers	Left and right speakers deliver stereo audio output.







## Closed Front View

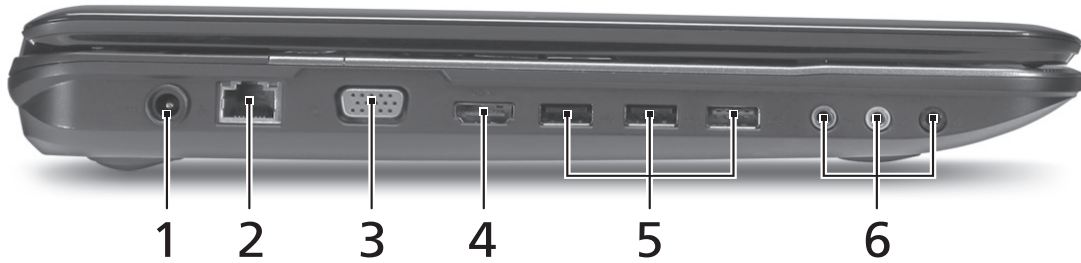

#	Icon	Item	Description
1		Multi-in-1 card reader	Accepts Secure Digital (SD), MultiMediaCard (MMC), Memory Stick (MS), Memory Stick PRO (MS PRO), xD-Picture Card (xD). <b>Note:</b> Push to remove/install the card. Only one card can operate at any given time.

## Left View





#	Icon	Item	Description
1		DC-in jack	Connects to an AC adapter.
2		Ethernet (RJ-45) port	Connects to an Ethernet 10/100/1000-based network.
3		External display (VGA) port	Connects to a display device (e.g., external monitor, LCD projector).
4	HDMI	HDMI port	Supports high definition digital video connections.
5		USB 2.0 port	Connect to USB 2.0 devices (e.g., USB mouse, USB camera).
6		Line-in jack	Accepts audio line-in devices (e.g., audio CD player, stereo walkman, mp3 player)
		Microphone jack	Accepts inputs from external microphones.
		Headphones/speaker/line-out jack with SPDIF support	Connects to audio line-out devices (e.g., speakers, headphones).

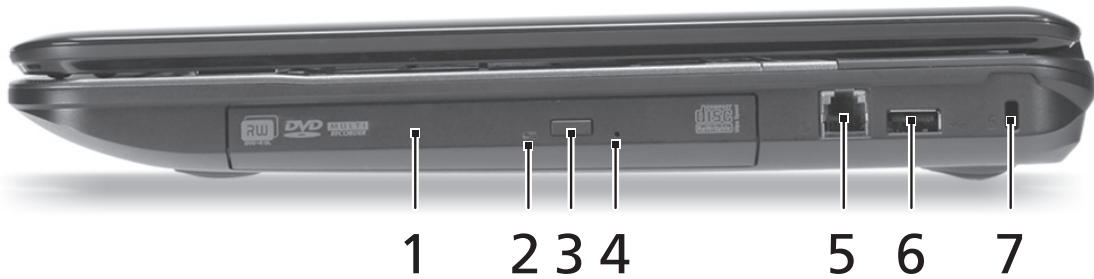

## Right View



#	Icon	Item	Description
1		Optical drive	Internal optical drive; accepts CDs or DVDs.
2		Optical disk access indicator	Lights up when the optical drive is active.
3		Optical drive eject button	Ejects the optical disk from the drive.
4		Emergency eject hole	Ejects the optical drive tray when the computer is turned off. <b>Note:</b> Insert a paper clip to the emergency eject hole to eject the optical drive tray when the computer is off.
5		Modem (RJ-11) port	Connects to a phone line.
6		USB 2.0 port	Connect to USB 2.0 devices (e.g., USB mouse, USB camera).
7		Kensington lock slot	Connects to a Kensington-compatible computer security lock.





## Rear View

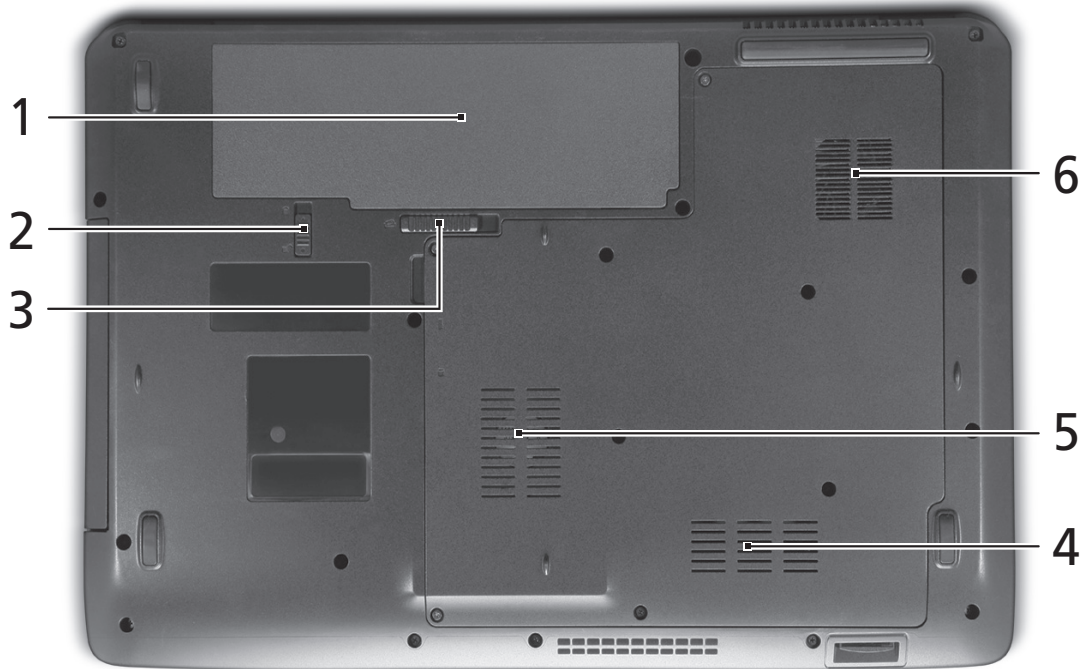

#	Item	Description
1	Ventilation slots	Enable the computer to stay cool, even after prolonged use.



## Bottom View



#	Icon	Item	Description
1		Battery bay	Houses the computer's battery pack.
2		Batter Lock	Locks the battery in position.
3		Battery release latch	Releases the battery for removal.
4		Memory compartment	Houses the computer's main memory.
5		Hard disk bay	Houses the computer's hard disk (secured with screws).
6		Ventilation slots and cooling fan	Enable the computer to stay cool, even after prolonged use. <b>Note:</b> Do not cover or obstruct the opening of the fan.

## Indicators



The computer has several easy-to-read status indicators.

Icon	Function	Description
	Power	Indicates the computer's power status.
	Battery	Indicates the computer's battery status. <b>1. Charging:</b> The light shows amber when the battery is charging. <b>2. Fully charged:</b> The light shows blue when in AC mode.

**NOTE:** **1. Charging:** The light shows amber when the battery is charging. **2. Fully charged:** The light shows green when in AC mode.

## Easy-Launch Buttons

Located on the left of the keyboard are the application buttons. These buttons are called easy-launch buttons. They are: WLAN, Bluetooth and Backup.

Icon	Function	Description
	Wireless LAN communication button/indicator	Enables/disables the wireless LAN function. Indicates the status of wireless LAN communication.
	Bluetooth communication button/indicator	Enables/disables the Bluetooth function. Indicates the status of Bluetooth communication. (only for certain models)
	Backup key	Launches Acer Backup Management for three-step data backup.

## Touchpad Basics (with fingerprint reader)

The following items show you how to use the touchpad with Acer Bio-Protection fingerprint reader.

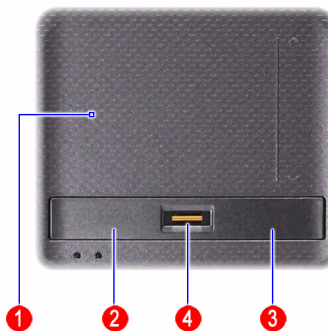

- Move your finger across the touchpad (2) to move the cursor.
- Press the left (1) and right (4) buttons located beneath the touchpad to perform selection and execution functions. These two buttons are similar to the left and right buttons on a mouse. Tapping on the touchpad is the same as clicking the left button.
- Use Acer Bio-Protection fingerprint reader (3) supporting Acer FingerNav 4-way control function (only for certain models) to scroll up or down and move left or right a page. This fingerprint reader or button mimics your cursor pressing on the right scroll bar of Windows applications.

Function	Left button (1)	Right button (4)	Main touchpad (2)	Center button (3)
Execute	Quickly click twice.		Tap twice (at the same speed as double-clicking a mouse button).	
Select	Click once.		Tap once.	
Drag	Click and hold, then use finger on the touchpad to drag the cursor.		Tap twice (at the same speed as double-clicking a mouse button); rest your finger on the touchpad on the second tap and drag the cursor.	
Access context menu		Click once.		

Function	Left button (1)	Right button (4)	Main touchpad (2)	Center button (3)
Scroll				Swipe up/down/left/right using Acer FingerNav 4-way control function (Manufacturing option).

## Touchpad basics (with two-click buttons)

The following items show you how to use the touchpad with two-click buttons.

- Move your finger across the touchpad **(1)** to move the cursor.
- Press the left **(2)** and right **(3)** buttons located beneath the touchpad to perform selection and execution functions. These two buttons are similar to the left and right buttons on a mouse. Tapping on the touchpad is the same as clicking the left button.

Function	Left button (2)	Right button (3)	Main touchpad (1)
Execute	Quickly click twice.		Tap twice (at the same speed as double-clicking a mouse button).
Select	Click once.		Tap once.
Drag	Click and hold, then use finger on the touchpad to drag the cursor.		Tap twice (at the same speed as double-clicking a mouse button); rest your finger on the touchpad on the second tap and drag the cursor.
Access context menu		Click once.	

**NOTE:** Illustrations are for reference only. The exact configuration of your PC depends on the model purchased.

**NOTE:** When using the touchpad, keep it — and your fingers — dry and clean. The touchpad is sensitive to finger movement; hence, the lighter the touch, the better the response. Tapping harder will not increase the touchpad's responsiveness.

**NOTE:** By default, vertical and horizontal scrolling is enabled on your touchpad. It can be disabled under Mouse settings in Windows Control Panel.

---

# Using the Keyboard

The keyboard has full-sized keys and an embedded numeric keypad, separate cursor, lock, Windows, function and special keys.

## Lock Keys and numeric keypad

The keyboard has three lock keys which you can toggle on and off.



















Lock key	Description
Caps Lock	When Caps Lock is on, all alphabetic characters typed are in uppercase.
Num Lock	When Num Lock is on, the numeric keypad is in numeric mode. The keys function as a calculator (complete with the arithmetic operators +, -, *, and /). Use this mode when you need to do a lot of numeric data entry. A better solution would be to connect an external keypad.
Scroll Lock <Fn> + <F12>	When Scroll Lock is on, the screen moves one line up or down when you press the up or down arrow keys respectively. Scroll Lock does not work with some applications.

The keyboard has a numeric keypad with cursor-control keys.

Desired access	Num Lock on	Num Lock off
Number keys on embedded keypad	Type numbers in a normal manner.	
Cursor-control keys on embedded keypad	Hold <Shift> while using cursor-control keys.	Hold <Fn> while using cursor-control keys.
Main keyboard keys	Hold <Fn> while typing letters on embedded keypad.	Type the letters in a normal manner.

# Windows Keys

The keyboard has two keys that perform Windows-specific functions.











Key	Description
 Windows key	<p>Pressed alone, this key has the same effect as clicking on the Windows Start button; it launches the Start menu. It can also be used with other keys to provide a variety of functions:</p> <ul style="list-style-type: none"> <li>&lt;  &gt;: Open or close the Start menu</li> <li>&lt;  &gt; + &lt;D&gt;: Display the desktop</li> <li>&lt;  &gt; + &lt;E&gt;: Open Windows Explore</li> <li>&lt;  &gt; + &lt;F&gt;: Search for a file or folder</li> <li>&lt;  &gt; + &lt;G&gt;: Cycle through Sidebar gadgets</li> <li>&lt;  &gt; + &lt;L&gt;: Lock your computer (if you are connected to a network domain), or switch users (if you're not connected to a network domain)</li> <li>&lt;  &gt; + &lt;M&gt;: Minimizes all windows</li> <li>&lt;  &gt; + &lt;R&gt;: Open the Run dialog box</li> <li>&lt;  &gt; + &lt;T&gt;: Cycle through programs on the taskbar</li> <li>&lt;  &gt; + &lt;U&gt;: Open Ease of Access Center</li> <li>&lt;  &gt; + &lt;X&gt;: Open Windows Mobility Center</li> <li>&lt;  &gt; + &lt;BREAK&gt;: Display the System Properties dialog box</li> <li>&lt;  &gt; + &lt;SHIFT+M&gt;: Restore minimized windows to the desktop</li> <li>&lt;  &gt; + &lt;TAB&gt;: Cycle through programs on the taskbar by using Windows Flip 3-D</li> <li>&lt;  &gt; + &lt;SPACEBAR&gt;: Bring all gadgets to the front and select Windows Sidebar</li> <li>&lt;CTRL&gt; + &lt;  &gt; + &lt;F&gt;: Search for computers (if you are on a network)</li> <li>&lt;CTRL&gt; + &lt;  &gt; + &lt;TAB&gt;: Use the arrow keys to cycle through programs on the taskbar by using Windows Flip 3-D</li> </ul> <p><b>Note:</b> Depending on your edition of Windows Vista, some shortcuts may not function as described.</p>
 Application key	<p>This key has the same effect as clicking the right mouse button; it opens the application's context menu.</p>

---

## Hot Keys

The computer employs hotkeys or key combinations to access most of the computer's controls like screen brightness, volume output and the BIOS utility.

To activate hot keys, press and hold the <Fn> key before pressing the other key in the hotkey combination.

Hotkey	Icon	Function	Description
<Fn> + <F2>		System property	Starts System Property for displaying system information.
<Fn> + <F3>		Bluetooth	Enables/disables the Bluetooth function.
<Fn> + <F4>		Sleep	Puts the computer in Sleep mode.
<Fn> + <F5>		Display toggle	Switches display output between the display screen, external monitor (if connected) and both.
<Fn> + <F6>		Screen blank	Turns the display screen backlight off to save power. Press any key to return.
<Fn> + <F8>		Speaker toggle	Turns the speakers on and off.
<Fn> + <↑>		Brightness up	Increases the screen brightness.
<Fn> + <↓>		Brightness down	Decreases the screen brightness.
<Fn> + <↑>		Volume up	Increases the sound volume.
<Fn> + <↓>		Volume down	Decreases the sound volume.

## Special Key (only for certain models)

You can locate the Euro symbol and the US dollar sign at the upper-center and/or bottom-right of your keyboard.

### The Euro symbol

1. Open a text editor or word processor.
2. Either press <€> on the keyboard, or hold <Alt Gr> and then press the <5> key at the upper-center of the keyboard.

**NOTE:** Some fonts and software do not support the Euro symbol. Please refer to [www.microsoft.com/typography/faq/faq12.htm](http://www.microsoft.com/typography/faq/faq12.htm) for more information.

### The US dollar sign

1. Open a text editor or word processor.
2. Either press <\$> at the bottom-right of the keyboard, or hold <Shift> and then press the <4> key at the upper-center of the keyboard.

**NOTE:** This function varies according to the language settings.

# Windows Mobility Center

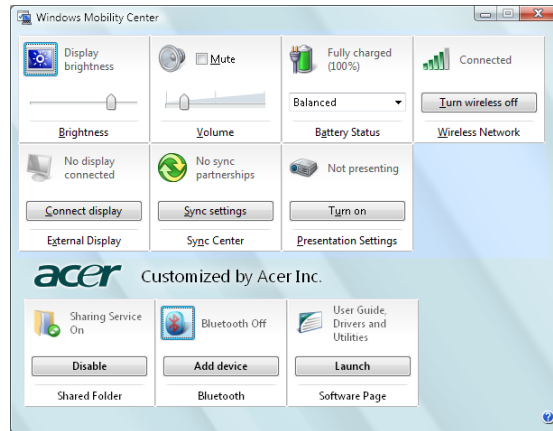

The Windows Mobility Center collects key mobile-related system settings in one easy-to-find place, so you can quickly configure your Acer system to fit the situation as you change locations, networks or activities. Settings include display brightness, volume, power plan, wireless networking on/off, external display settings, synchronization status and presentation settings.

Windows Mobility Center also includes Acer-specific settings like sharing folders overview/sharing service on or off, Bluetooth Add Device (if applicable), and a shortcut to the Acer user guide, drivers and utilities.

To launch Windows Mobility Center:

- q Use the shortcut key <img alt="Windows logo" data-bbox="278 438 308 458"/> + <X>.
- q Start Windows Mobility Center from the Control panel.
- q Start Windows Mobility Center from the Accessories program group in the Start menu.
- q Launch Windows Mobility Center by right-clicking  in the system tray and select **Windows Mobility Center**.



---

# Using the System Utilities

## Acer Bio-Protection (only for certain models)

Acer Bio-Protection Fingerprint Solution is a multi-purpose fingerprint software package integrated with the Microsoft Windows operating system. Utilizing the uniqueness of one's fingerprint features, Acer Bio-Protection Fingerprint Solution has incorporated protection against unauthorized access to your computer with centralized password management with Password Bank, easy music player launching with Acer MusicLaunch, secure Internet favorites via Acer MyLaunch, and fast application/website launching and login with Acer FingerLaunch, while Acer ProfileLaunch can launch up to three applications/websites from a single finger swipe.

Acer Bio-Protection Fingerprint Solution also allows you to navigate through web browsers and documents using Acer FingerNav. With Acer Bio-Protection Fingerprint Solution, you can now enjoy an extra layer of protection for your personal computer, as well as the convenience of accessing your daily tasks with a simple swipe of your finger!

For more information refer to the Acer Bio-Protection help files.

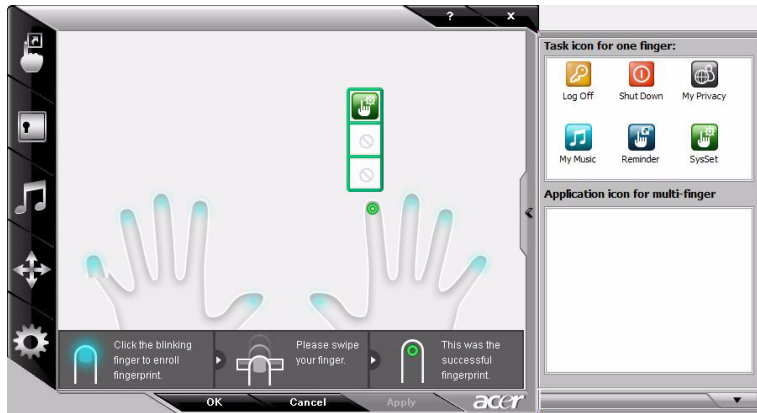

# Acer GridVista (dual-display compatible)

**NOTE:** This feature is only available on certain models.

To enable the dual monitor feature of the notebook, first ensure that the second monitor is connected, then select **Start, Control Panel, Display** and click on **Settings**. Select the secondary monitor (2) icon in the display box and then click the check box **Extend my windows desktop onto this monitor**. Finally, click **Apply** to confirm the new settings and click **OK** to complete the process.

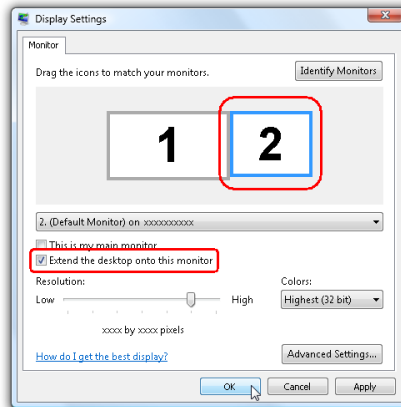

Acer GridVista is a handy utility that offers four pre-defined display settings so you can view multiple windows on the same screen. To access this function, please go to **Start>All Programs** and click on **Acer GridVista**. You may choose any one of the four display settings indicated below:

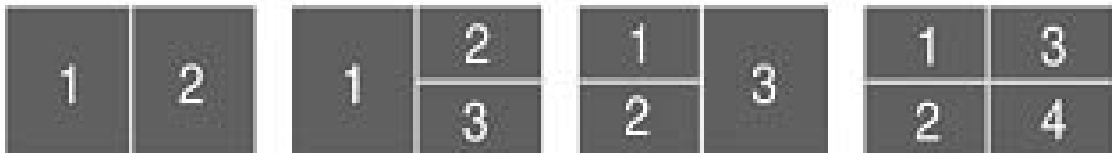

Double (vertical), Triple (primary at left), Triple (primary at right), or Quad Acer GridVista is dual-display compatible, allowing two displays to be partitioned independently.

Acer GridVista is dual-display compatible, allowing two displays to be partitioned independently.

AcerGridVista is simple to set up:

1. Run Acer GridVista and select your preferred screen configuration for each display from the task bar.
2. Drag and drop each window into the appropriate grid.
3. Enjoy the convenience of a well-organized desktop.

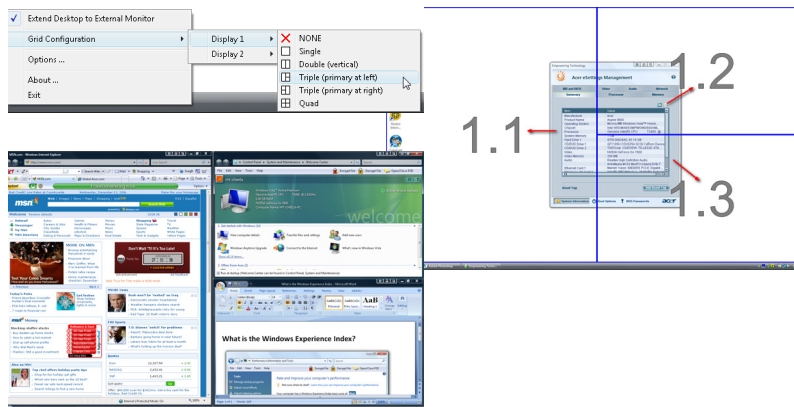

**NOTE:** Please ensure that the resolution setting of the second monitor is set to the manufacturer's recommended value.

# Hardware Specifications and Configurations

## Processor

Item	Specification
CPU type	Aspire 7736/7336 Series: Intel® Core™2 Duo P8800 PGA (2.66 GHz) Intel® Core™2 Duo T6500 PGA (2.1 GHz) Intel Celeron 900 PGA (2.2 GHz) Aspire 7736Z Series: Intel Pentium Dual-Core T4200 PGA (2.0 GHz) Aspire 7540 Series: AMD Turion II M520 2.3 GHz AMD Athlon II M320 2.1 GHz AMD Turion M620 2.5 GHz
Core logic	Aspire 7736/7736Z/7336 Series: Mobile Intel® PM45/GM45/GL40 Express Chipset Aspire 7540 Series: AMD M880G Chipset
CPU package	Aspire 7736/7736Z/7336 Series: 478-pin micro-FCPGA Aspire 7540 Series: Socket S1
CPU core voltage	Aspire 7736/7736Z/7336 Series: 1.0375V to 1.3V Aspire 7540 Series: 1.35V to 1.5V

## CPU Fan True Value Table

DTS(degree C)	Fan Speed (rpm)	Acoustic Level (dBA)
45-50	0-3000	29
55-66	0-3300	33
68-74	3300-3800	38
78-83	3800-4100	40
86-91	4100-4800	40

Throttling 50%: On= 99° C; OFF=93° C

OS shut down at 105° C; H/W shot down at 110° .C

## BIOS

Item	Specification
BIOS vendor	Phoenix
BIOS Version	Aspire 7736/7736Z/7336 Series: v1.16 Aspire 7540 Series: v1.07

## System Memory

Item	Specification
Memory controller	Built-in
Memory size	0MB (no on-board memory)
DIMM socket number	2 sockets
Supports memory size per socket	2048MB
Supports maximum memory size	4GB for 64bit OS (with two 2GB SODIMM)
Supports DIMM type	DDR 2 Synchronous DRAM
Supports DIMM Speed	667 MHz
Supports DIMM voltage	1.5V
Supports DIMM package	240-pin soDIMM

## System Memory

Item	Specification
Memory module combinations	You can install memory modules in any combinations as long as they match the above specifications.

## Memory Combinations

Slot 1	Slot 2	Total Memory
0MB	1024MB	1024MB
0MB	2048MB	2048MB
1024MB	0MB	1024MB
1024MB	1024MB	2048MB
1024MB	2048MB	3072MB
2048MB	0MB	2048MB
2048MB	1024MB	3072MB
2048MB	2048MB	4096MB
0MB	4096MB	4096MB
4096MB	0MB	4096MB

**NOTE:** Above table lists some system memory configurations. You may combine DIMMs with various capacities to form other combinations. On above table, the configuration of slot 1 and slot 2 could be reversed.

Item	Specification
LAN Chipset	Broadcom BCM5784
Supports LAN protocol	10/100/1000 Mbps
LAN connector type	RJ45
LAN connector location	Left side
Features	Integrated 10/100 BASE-T transceiver Wake on LAN support compliant with ACPI 1.0b/2.0/3.0 PCI v2.2

## Bluetooth Interface

Item	Specification
Chipset	Foxconn Bluetooth BRM 2046 BT2.1
Data throughput	723 bps (full speed data rate)
Protocol	Bluetooth 2.1
Interface	USB
Connector type	USB

## Wireless Module 802.11b/g/n

Item	Specification
Chipset	Aspire 7736 series: Lan Intel WLAN 512AN_HMWG Shirley Peak 5100 MM#895373; Lan Intel WLAN 512AN_MMWG Shirley Peak 5100 MM#895361 Aspire 7736Z Series: Foxconn Wirelss LAN Atheros HB95 1x1 BG (HM) Aspire 7336 series: QMI Wireless LAN Atheros HB93 1x2 BGN (HM) EM306 Aspire 7540 Series: QMI Wireless LAN Atheros HB93 1x2 BGN (HM) EM306; Foxconn Wirelss LAN Atheros HB95 1x1 BG (HM)
Data throughput	11~54 Mbps, up to 270 Mbps for Draft-N
Protocol	802.11b+g, Draft-N
Interface	PCI bus (mini PCI socket for wireless module)

## Hard Disk Drive

Item				
Vendor & Model Name	HGST 2.5" HTS545016B9A300 Panther B SATA LF F/W:C60F	HGST 2.5" HTS545025B9A300 Panther B SATA LF F/W:C60F WD 2.5" WD2500BEVT-22ZCT0 ML160 SATA LF F/W:11.01A11	HGST 2.5" HTS545032B9A300 Panther B SATA LF F/W:C60F	WD 2.5" WD5000BEVT-22ZAT0 ML250 SATA LF F/W:01.01A01
Capacity (MB)	160000	250000	320000	500000
Bytes per sector	512	512	512	512
Data heads	3/4	2	3	4
Drive Format				
Disks	2	2	2	2
Spindle speed (RPM)	5400 RPM	5400 RPM	5400 RPM	5400 RPM
Performance Specifications				
Buffer size	8MB	8MB	8MB	8MB
Interface	SATA	SATA	SATA	SATA
Max. media transfer rate (disk-buffer, Mbytes/s)	540	875 (Max. 3.0 Gbit/s Buffer-host data transfer)	875 (Max. 3.0 Gbit/s Buffer-host data transfer)	875 (Max. 3.0 Gbit/s Buffer-host data transfer)
DC Power Requirements				
Voltage tolerance	5V(DC) +/- 5%	5V(DC) +/- 5%	5V(DC) +/- 5%	5V(DC) +/- 5%

## Optical Disc Drive

Item	Specification	
Vendor & model name	HLDS Super-Multi DRIVE 12.7mm Tray DL 8X GT30N LF TOSHIBA Super-Multi DRIVE 12.7mm Tray DL 8X TS-L633C LF	
Performance Specification	With CD Diskette	With DVD Diskette
Transfer rate (KB/sec)	Sustained: Max 3.6Mbytes/sec	Sustained: Max 10.08Mbytes/sec
Buffer Memory	2MB	
Interface	SATA	

### Optical Disc Drive

Item	Specification
Applicable disc format	Applicable disc format CD: CD-DA, CD-ROM, CD-ROM XA, Photo CD (multi-session), Video CD, Cd-Extra (CD+), CD-text DVD: DVD-VIDEO, DVD-ROM, DVD-R (3.9GB, 4.7GB) DVD-R DL, DVD-RW, DVD-RAM, DVD+R, DVD+R DL, DVD+RW CD: CD-DA (Red Book) - Standard Audio CD & CD-TEXT CD-ROM (Yellow Book Mode1 & 2) - Standard Data CD-ROM XA (Mode2 Form1 & 2) - Photo CD, Multi-Session CD-I (Green Book, Mode2 Form1 & 2, Ready, Bridge) CD-Extra/ CD-Plus (Blue Book) - Audio & Text/Video Video-CD (White Book) - MPEG1 Video CD-R (Orange Book Part) CD-RW & HSRW (Orange Book Part Volume1 & Volume 2 Super Audio CD (SACD) Hybrid type US & US+ RW DVD: DVD-ROM (Book 1.02), DVD-Dual DVD-Video (Book 1.1) DVD-R (Book 1.0, 3.9G) DVD-R (Book 2.0, 4.7G) - General & Authoring DVD+R (Version 1.0) DVD+RW DVD-RW (Non CPRM & CPRM) DVD <sup>o</sup> R Dual
Loading mechanism	Load: Manual Release: (a) Electrical Release (Release Button) (b) Release by ATAPI command (c) Emergency Release
Power Requirement	
Input Voltage	5 V +/- 5% (Operating)

### Blu-Ray Disc Drive

Item	Specification		
Vendor & model name	HLDS BD COMBO DRIVE TRAY DL 4X CT10 LF SONY BD COMBO 12.7mm Tray DL 4X BC-5500S LF		
Performance Specification	With CD Disc	With DVD Disc	With Blu-ray Disc
Transfer rate (KB/sec)	Sustained: Max 3.6Mbytes/sec	Sustained: Max 10.08Mbytes/sec	Sustained: Max 11 Mbytes/sec
Buffer Memory	2MB		4.5 MB
Interface	SATA		

## Blu-Ray Disc Drive

Item	Specification
Applicable disc format	<p>Applicable disc format</p> <p>CD: CD-DA, CD-ROM, CD-ROM XA, Photo CD (multi-session), Video CD, Cd-Extra (CD+), CD-text</p> <p>DVD: DVD-VIDEO, DVD-ROM, DVD-R (3.9GB, 4.7GB) DVD-R DL, DVD-RW, DVD-RAM, DVD+R, DVD+R DL, DVD+RW</p> <p>CD:</p> <p>CD-DA (Red Book) - Standard Audio CD &amp; CD-TEXT</p> <p>CD-ROM (Yellow Book Mode1 &amp; 2) - Standard Data</p> <p>CD-ROM XA (Mode2 Form1 &amp; 2) - Photo CD, Multi-Session</p> <p>CD-I (Green Book, Mode2 Form1 &amp; 2, Ready, Bridge)</p> <p>CD-Extra/ CD-Plus (Blue Book) - Audio &amp; Text/Video</p> <p>Video-CD (White Book) - MPEG1 Video</p> <p>CD-R (Orange Book Part)</p> <p>CD-RW &amp; HSRW (Orange Book Part Volume1 &amp; Volume 2)</p> <p>Super Audio CD (SACD) Hybrid type</p> <p>US &amp; US+ RW</p> <p>DVD:</p> <p>DVD-ROM (Book 1.02), DVD-Dual</p> <p>DVD-Video (Book 1.1)</p> <p>DVD-R (Book 1.0, 3.9G)</p> <p>DVD-R (Book 2.0, 4.7G) - General &amp; Authoring</p> <p>DVD+R (Version 1.0)</p> <p>DVD+RW</p> <p>DVD-RW (Non CPRM &amp; CPRM)</p> <p>DVD+/-R Dual</p> <p>Blu-Ray:</p> <p>BD-R, BD-R DL, BD-RE, BD-RE DL</p>
Loading mechanism	<p>Load: Manual</p> <p>Release: (a) Electrical Release (Release Button)</p> <p>(b) Release by ATAPI command</p> <p>(c) Emergency Release</p>
Power Requirement	
Input Voltage	5 V +/- 5% (Operating)

## Audio Interface

Item	Specification
Audio Controller	Realtek ALC888S
Audio onboard or optional	Built-in
Mono or Stereo	Stereo
Resolution	18 bit stereo full duplex
Compatibility	HD audio Interface; S/PDIF output for PCM or AC-3 content
Sampling rate	1Hz resolution VSR (Variable Sampling Rate)
Internal microphone	Yes
Internal speaker / Quantity	Yes/2.1 (1.5 W speakers)

## Video Memory

Item	Specification
Chipset	Aspire 7736/7736Z/7336 Series: <ul style="list-style-type: none"> <li>• Mobile Intel® GL40 Express Chipset*</li> <li>• Mobile Intel® GM45 Express Chipset*</li> <li>• NVIDIA® GeForce® G210M*</li> </ul> Aspire 7540 Series: <ul style="list-style-type: none"> <li>• ATI Radeon™ HD 200 Graphics*</li> <li>• ATI Mobility Radeon™ HD 4570*</li> </ul>
Memory size	1024M DDR3

## USB

Item	Specification
Chipset	Aspire 7736/7736Z/7336 Series: ICH9M Aspire 7540 Series: AMD SB710
USB Compliancy Level	2.0
OHCI	USB 1.1 and USB 2.0 Host controller
Number of USB ports	5
Location	Three on the right side/two on the left side
Serial port function control	Enable/Disable by BIOS Setup

## System Board Major Chips

Item	Controller
Core logic	Aspire 7736/7736Z/7336 Series: Mobile Intel® GM45/ GL40/PM45 Aspire 7540 Series: ATI RS780MN
USB 2.0	Aspire 7736/7736Z/7336 Series: Intel ICH-9M Aspire 7540 Series: AMD SB710
Super I/O controller	N/A
MODEM	Aspire 7736/7736Z/7336 Series: Lite-On Conexant - Unizion 1.5_3.3v AUS RD02-D330; Foxconn Delphi-AM5 V2H 1.5_3.3v AUS T60M951; Aspire 7540 Series: Foxconn Delphi-AM5 V2H 1.5_3.3v AUS T60M951
Bluetooth	Aspire 7736/7736Z/7336 Series: Foxconn Bluetooth BRM 2046 BT2.1 (T60H928.33) Aspire 7540 Series: Foxconn BCM2046 V2.1 (T60H928.33)
Wireless 802.11 b/g/n	Aspire 7736/7736Z/7336 Series: Lan Intel WLAN 512AN_MMWG Shirley Peak 5100 MM#895373; Foxconn Wireless LAN Atheros HB95 1x1 BG (HM); Lan Intel WLAN 512AN_MMWG Shirley Peak 5100 MM#895361; QMI Wireless LAN Atheros HB93 1x2 BGN (HM) EM306 Aspire 7540 Series: QMI Wireless LAN Atheros HB93 1x2 BGN (HM) EM306; Foxconn Wireless LAN Atheros HB95 1x1 BG (HM);
Multi-in-1 Card Reader	Realtek RTS5159



### System Board Major Chips

Item	Controller
Audio Codec	Realtek ALC888s

### Keyboard

Item	Specification
Keyboard controller	Winbond WPCE773
Total number of keypads	103-/104-/107-key keyboard
Windows logo key	Yes
Internal & external keyboard work simultaneously	Plug USB keyboard to the USB port directly: Yes

### Battery

Item	Specification
Vendor	SONY/SANYO/PANASONIC/SIMPLO
Battery Type	Li-ion
Pack capacity	4400/4800mAh
Number of battery cell	6/8
Package configuration	3/4 cells in series, 2 series in parallel

### LCD 17.3" inch

Item	Specification
Vendor & model name	AUO/CMO/LPL
Screen Diagonal (mm)	17.3 inches
Display resolution (pixels)	17.3" WXGA+ Glare
Pixel Pitch	0.204 x 0.204
Pixel Arrangement	R.G.B. Vertical Stripe
Display Mode	Normally White
Typical White Luminance (NIT) also called Brightness	220
Luminance Uniformity	1.25 max.
Contrast Ratio	400 typical
Response Time msec	8
Nominal Input Voltage VDD	+3.3V
Viewing Angle (degree) Horizontal: Right/Left Vertical: Upper/Lower	45/45 15/35
Temperature Range(° C) Operating Storage (shipping)	0 to +50 -40 to +60

### AC Adaptor

Item	Specification
Input	100-240V~ 1.5A, 50-60Hz

---

## AC Adaptor

Item	Specification
Output	19V, 65W/90W

## System Power Management

ACPI mode	Power Management
Mech. Off (G3)	All devices in the system are turned off completely.
Soft Off (G2/S5)	OS initiated shutdown. All devices in the system are turned off completely.
Working (G0/S0)	Individual devices such as the CPU and hard disc may be power managed in this state.
Suspend to RAM (S3)	CPU set power down VGA Suspend PCMCIA Suspend Audio Power Down Hard Disk Power Down CD-ROM Power Down Super I/O Low Power mode
Save to Disk (S4)	Also called Hibernation Mode. System saves all system states and data onto the disc prior to power off the whole system.

# System Utilities

## BIOS Setup Utility

The BIOS Setup Utility is a hardware configuration program built into your computer's BIOS (Basic Input/Output System).

Your computer is already properly configured and optimized, and you do not need to run this utility. However, if you encounter configuration problems, you may need to run Setup. Please also refer to Chapter 4 Troubleshooting when problem arises.

To activate the BIOS Utility, press **F2** during POST (when "Press <F2> to enter Setup" message is prompted on the bottom of screen).

Press **F2** to enter setup. The default parameter of F12 Boot Menu is set to "disabled". If you want to change boot device without entering BIOS Setup Utility, please set the parameter to "enabled".

Press <F12> during POST to enter multi-boot menu. In this menu, user can change boot device without entering BIOS SETUP Utility.

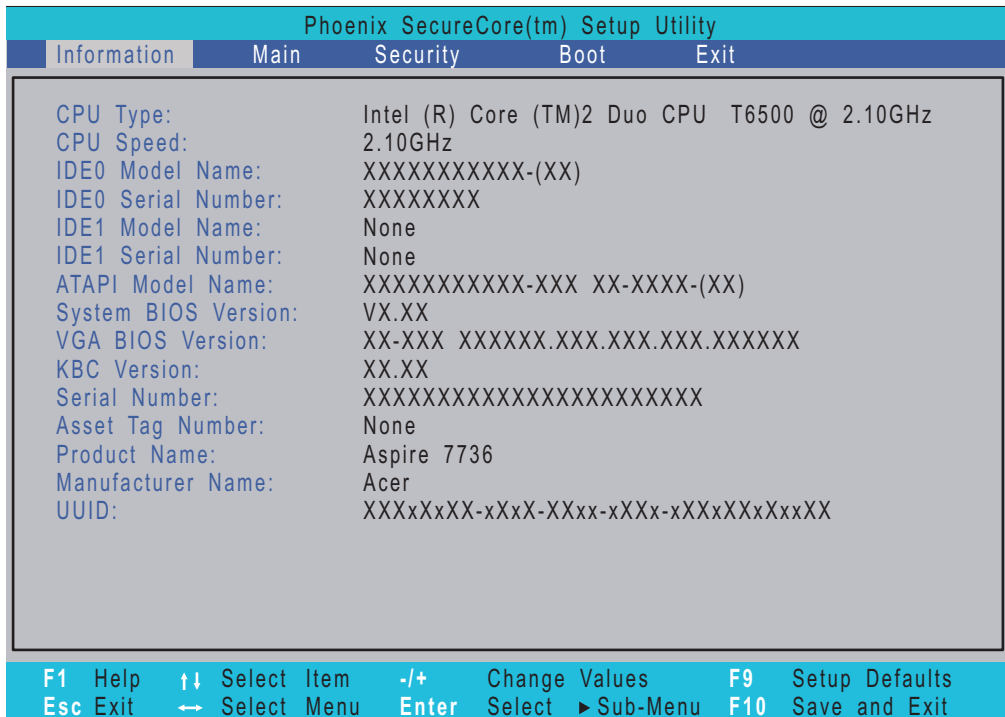

---

## Navigating the BIOS Utility

There are five menu options: Information, Main, Security, Boot, and Exit.

Follow these instructions:

- To choose a menu, use the left and right arrow keys.
- To choose an item, use the up and down arrow keys.
- To change the value of a parameter, press **F5** or **F6**.
- A plus sign (+) indicates the item has sub-items. Press **Enter** to expand this item.
- Press **Esc** while you are in any of the menu options to go to the Exit menu.
- In any menu, you can load default settings by pressing **F9**. You can also press **F10** to save any changes made and exit the BIOS Setup Utility.

**NOTE:** You can change the value of a parameter if it is enclosed in square brackets. Navigation keys for a particular menu are shown on the bottom of the screen. Help for parameters are found in the Item Specific Help part of the screen. Read this carefully when making changes to parameter values. **Please note that system information is subject to different models.**

# Information

The Information screen displays a summary of your computer hardware information.

Aspire 7736/7736Z/7336 Series:

Phoenix SecureCore(tm) Setup Utility				
Information	Main	Security	Boot	Exit
CPU Type:	Intel (R) Core (TM)2 Duo CPU T6500 @ 2.10GHz			
CPU Speed:	2.10GHz			
IDE0 Model Name:	XXXXXXXXXXXX-(XX)			
IDE0 Serial Number:	XXXXXXXXXX			
IDE1 Model Name:	None			
IDE1 Serial Number:	None			
ATAPI Model Name:	XXXXXXXXXXXX-XXX XX-XXXX-(XX)			
System BIOS Version:	VX.XX			
VGA BIOS Version:	XX-XXX XXXXXXX.XXX.XXX.XXX.XXXXXX			
KBC Version:	XX.XX			
Serial Number:	XXXXXXXXXXXXXXXXXXXXXXXXXXXX			
Asset Tag Number:	None			
Product Name:	Aspire 7736			
Manufacturer Name:	Acer			
UUID:	XXXxXxXX-xXxX-XXxx-xXXx-xXXxXXxXxxXX			
<b>F1</b> Help <b>↑↓</b> Select Item <b>-/+</b> Change Values <b>F9</b> Setup Defaults <b>Esc</b> Exit <b>←→</b> Select Menu <b>Enter</b> Select <b>▶</b> Sub-Menu <b>F10</b> Save and Exit				

Aspire 7540 Series:

Phoenix SecureCore(tm) Setup Utility				
Information	Main	Security	Boot	Exit
CPU Type:	AMD Turion (tm) II Dual-Core Mobile M520			
CPU Speed:	2.30GHz			
IDE0 Model Name:	XXXXXXXXXXXX-(XX)			
IDE0 Serial Number:	XXXXXXXXXX			
ATAPI Model Name:	XXXXXXXXXXXX-XXX XX-XXXX-(XX)			
System BIOS Version:	VX.XX			
VGA BIOS Version:	XX-XXX XXXXXXX.XXX.XXX.XXX.XXXXXX			
KBC Version:	XX.XX			
Serial Number:	XXXXXXXXXXXXXXXXXXXXXXXXXXXX			
Asset Tag Number:	None			
Product Name:	Aspire 7540			
Manufacturer Name:	Acer			
UUID:	XXXxXxXX-xXxX-XXxx-xXXx-xXXxXXxXxxXX			
<b>F1</b> Help <b>↑↓</b> Select Item <b>-/+</b> Change Values <b>F9</b> Setup Defaults <b>Esc</b> Exit <b>←→</b> Select Menu <b>Enter</b> Select <b>▶</b> Sub-Menu <b>F10</b> Save and Exit				

**NOTE:** The system information is subject to different models.

<b>Parameter</b>	<b>Description</b>
CPU Type	This field shows the CPU type and speed of the system.
CPU Speed	This field shows the speed of the CPU.
IDE0 Model Name	This field shows the model name of HDD installed on primary IDE master.
IDE0 Serial Number	This field displays the serial number of HDD installed on primary IDE master.
IDE1 Model Name	This field shows the model name of HDD installed on secondary IDE master.
IDE1 Serial Number	This field displays the serial number of HDD installed on secondary IDE master.
ATAPI Model Name	This field shows the model name of the Optical device installed in the system.
System BIOS Version	Displays system BIOS version.
VGA BIOS Version	This field displays the VGA firmware version of the system.
KBC Ver	This field shows the keyboard
Serial Number	This field displays the serial number of this unit.
Asset Tag Number	This field displays the asset tag number of the system.
Product Name	This field shows product name of the system.
Manufacturer Name	This field displays the manufacturer of this system.
UUID Number	Universally Unique Identifier (UUID) is an identifier standard used in software construction, standardized by the Open Software Foundation (OSF) as part of the Distributed Computing Environment (DCE).

# Main

The Main screen allows the user to set the system time and date as well as enable and disable boot option and recovery.

Aspire 7736/7736Z/7336 Series:

Phoenix SecureCore(tm) Setup Utility				
Information	Main	Security	Boot	Exit
System Time: [10:10:10] System Date: [03/30/2009]  System Memory: 640 KB Extended Memory: 957 MB Video Memory: 64 MB  Quiet Boot: [Enabled] Network Boot: [Enabled] F12 Boot Menu: [Disabled] D2D Recovery: [Enabled] SATAMode [AHCI]				Item Specific Help  <Tab>, <Shift-Tab>, or <Enter> selects field.
F1 Help	↑↓ Select Item	-/+ Change Values	F9 Setup Defaults	
Esc Exit	←→ Select Menu	Enter Select	▶ Sub-Menu	F10 Save and Exit

Aspire 7540 Series:

Phoenix SecureCore(tm) Setup Utility				
Information	Main	Security	Boot	Exit
System Time: [10:10:10] System Date: [03/31/2009]  Total Memory: 4096 KB Video Memory: 1024 MB  Quiet Boot: [Enabled] Network Boot: [Enabled] F12 Boot Menu: [Disabled] D2D Recovery: [Enabled] SATAMode [AHCI Mode]				Item Specific Help  <Tab>, <Shift-Tab>, or <Enter> selects field.
F1 Help	↑↓ Select Item	-/+ Change Values	F9 Setup Defaults	
Esc Exit	←→ Select Menu	Enter Select	▶ Sub-Menu	F10 Save and Exit

**NOTE:** The screen above is for your reference only. Actual values may differ.

The table below describes the parameters in this screen. Settings in **boldface** are the default and suggested parameter settings.

Parameter	Description	Format/Option
System Time	Sets the system time. The hours are displayed with 24-hour format.	Format: HH:MM:SS (hour:minute:second) System Time
System Date	Sets the system date.	Format MM/DD/YYYY (month/day/year) System Date
System Memory	This field reports the memory size of the system. Memory size is fixed to 640MB	
Total Memory	This field reports the total memory size of the system. For Aspire 8530 Series only.	
Extended Memory	This field reports the memory size of the extended memory in the system. Extended Memory size=Total memory size-1MB	
VGA Memory	Shows the VGA memory size.	
Quiet Boot	Determines if Customer Logo will be displayed or not; shows Summary Screen is disabled or enabled.  Enabled: Customer Logo is displayed, and Summary Screen is disabled.  Disabled: Customer Logo is not displayed, and Summary Screen is enabled.	Option: <b>Enabled</b> or Disabled
Network Boot	Enables, disables the system boot from LAN (remote server).	Option: <b>Enabled</b> or Disabled
F12 Boot Menu	Enables, disables Boot Menu during POST.	Option: <b>Disabled</b> or Enabled
D2D Recovery	Enables, disables D2D Recovery function. The function allows the user to create a hidden partition on hard disc drive to store operation system and restore the system to factory defaults.	Option: <b>Enabled</b> or Disabled
SATA Mode	Control the mode in which the SATA controller should operate.	Option: <b>AHCI</b> or IDE

**NOTE:** The sub-items under each device will not be shown if the device control is set to disable or auto. This is because the user is not allowed to control the settings in these cases.



# Security

The Security screen contains parameters that help safeguard and protect your computer from unauthorized use.

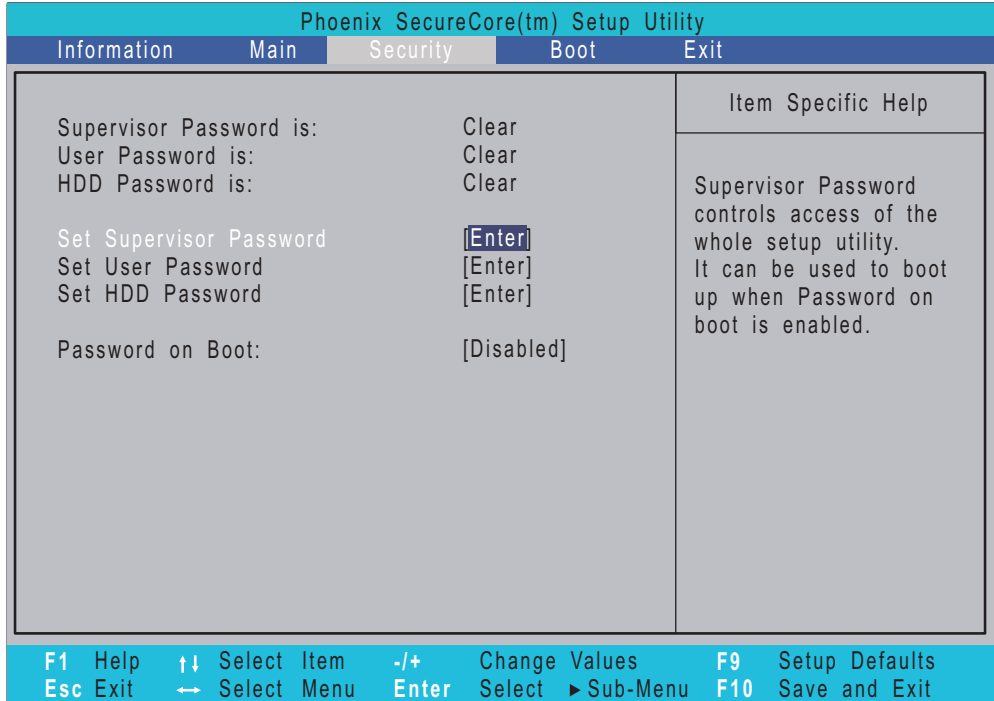

**NOTE:** Please refer to "Remove HDD/BIOS Password" section if you need to know how to remove HDD/BIOS Password.

The table below describes the parameters in this screen. Settings in **boldface** are the default and suggested parameter settings.

Parameter	Description	Option
Supervisor Password Is	Shows the setting of the Supervisor password	<b>Clear</b> or Set
User Password Is	Shows the setting of the user password.	<b>Clear</b> or Set
HDD Password Is	Shows the setting of the hard disk password.	<b>Clear</b> or Set
Set Supervisor Password	Press Enter to set the supervisor password. When set, this password protects the BIOS Setup Utility from unauthorized access. The user can not either enter the Setup menu nor change the value of parameters.	
Set User Password	Press Enter to set the user password. When user password is set, this password protects the BIOS Setup Utility from unauthorized access. The user can enter Setup menu only and does not have right to change the value of parameters.	
Set HDD Password	Enter HDD Password.	
Password on Boot	Defines whether a password is required or not while the events defined in this group happened. The following sub-options are all requires the Supervisor password for changes and should be grayed out if the user password was used to enter setup.	<b>Disabled</b> or Enabled

**NOTE:** When you are prompted to enter a password, you have three tries before the system halts. Don't forget your password. If you forget your password, you may have to return your notebook computer to your dealer to reset it.

## Setting a Password

Follow these steps as you set the user or the supervisor password:

1. Use the up/down keys to highlight the Set Supervisor Password parameter and press the Enter key. The Set Supervisor Password box appears:

Set Supervisor Password

Enter New Password [                    ]

Confirm New Password [                    ]

2. Type a password in the "Enter New Password" field. The password length can not exceeds 8 alphanumeric characters (A-Z, a-z, 0-9, not case sensitive). Retype the password in the "Confirm New Password" field.

**IMPORTANT:** Be very careful when typing your password because the characters do not appear on the screen.

3. Press Enter.  
After setting the password, the computer sets the User Password parameter to "Set".
4. If desired, you can opt to enable the Password on boot parameter.
5. When you are done, press F10 to save the changes and exit the BIOS Setup Utility.

## Removing a Password

Follow these steps:

1. Use the up/down keys to highlight the Set Supervisor Password parameter and press the Enter key. The Set Password box appears:

Set Supervisor Password		
Enter current password	[	]
Enter New Password	[	]
Confirm New Password	[	]

2. Type the current password in the Enter Current Password field and press Enter.
3. Press Enter twice **without** typing anything in the Enter New Password and Confirm New Password fields. The computer then sets the Supervisor Password parameter to "Clear".
4. When you have changed the settings, press F10 to save the changes and exit the BIOS Setup Utility.

## Changing a Password

1. Use the up/down keys to highlight the Set Supervisor Password parameter and press the Enter key. The Set Password box appears:

Set Supervisor Password		
Enter current password	[	]
Enter New Password	[	]
Confirm New Password	[	]

2. Type the current password in the Enter Current Password field and press Enter.
3. Type a password in the Enter New Password field. Retype the password in the Confirm New Password field.
4. Press Enter. After setting the password, the computer sets the User Password parameter to "Set".
5. If desired, you can enable the Password on boot parameter.
6. When you are done, press F10 to save the changes and exit the BIOS Setup Utility.

If the verification is OK, the screen will display as following.

Setup Notice	
Changes have been saved.	
[ continue]	

The password setting is complete after the user presses Enter.

If the current password entered does not match the actual current password, the screen will show you the Setup Warning.

---

Setup Warning  
Invalid password  
Re-enter Password  
[ continue]

If the new password and confirm new password strings do not match, the screen will display the following message.

Setup Warning  
Password do not match  
Re-enter Password

# Boot

This menu allows the user to decide the order of boot devices to load the operating system. Bootable devices includes the diskette drive in module bay, the onboard hard disk drive and the CD-ROM in module bay.

Phoenix SecureCore(tm) Setup Utility				
Information	Main	Security	Boot	Exit
Boot priority order:			Item Specific Help	
1: IDE0 HDD: XXXXXXXXXXXX-(XX)			Use <↑> or <↓> to select a device, then press <F6> to move it up the list, or <F5> to move it down the list. Press <Esc> to escape the menu.	
2: IDE1:				
3: CD/DVD: XXXXXXXXXXXX-XXX XX-XXXX-XX				
4: Network Boot: XXX vXX.X.X XXXX XXXX				
5: USB HDD:				
6: USB FDD:				
7: USB Key:				
8: USB CD/DVD ROM:				
F1 Help	↑↓ Select Item	-/+ Change Values	F9 Setup Defaults	
Esc Exit	←→ Select Menu	Enter Select	▶ Sub-Menu	F10 Save and Exit

# Exit

The Exit screen contains parameters that confirmed or discard the changes made to the parameters in the BIOS Setup Utility.

The table below describes the parameters in this screen.

Parameter	Description
Exit Saving Changes	Exit System Setup and save your changes to CMOS.
Exit Discarding Changes	Exit utility without saving setup data to CMOS.
Load Setup Default	Load default values for all SETUP item.
Discard Changes	Load previous values from CMOS for all SETUP items.
Save Changes	Save Setup Data to CMOS.

---

# BIOS Flash Utility

The BIOS flash memory update is required for the following conditions:

- New versions of system programs
- New features or options
- Restore a BIOS when it becomes corrupted.

Use the Flash utility to update the system BIOS flash ROM.

**NOTE:** If you do not have a crisis recovery disk at hand, then you should create a **Crisis Disk** (See “Steps for BIOS Recovery by Crisis Disk” on page 107) before you use the Flash utility.

**NOTE:** Do not install memory-related drivers (XMS, EMS, DPMI) when you use the Flash.

**NOTE:** Please connect the AC adapter power supply when you run the Flash utility. If the battery pack does not contain enough power to finish BIOS flash, you may not boot the system because the BIOS is not completely loaded.

Follow the steps below to run the Flash utility:

1. Rename the BIOS file as “XXXXXXX.FD”
2. Copy the “XXXXXXX.FD” file to a bootable USB device containing the Crisis Disk.
3. Turn off the system power.
4. Insert the USB device containing the renamed BIOS file and Crisis Disk to any USB port.
5. Make sure the AC adapter is connected to a power outlet and plugged in to the system.
6. Power on the system from an off state (i.e. cold boot) while holding down the Fn + ESC key.
7. After POST, release Fn + ESC key. The system should boot from the USB device and perform crisis recovery action.

---

# Remove HDD Password

This section teaches you how to remove HDD password:

## Remove HDD Password:

- If you key in the wrong HDD password thrice, “HDD password error code” will appear on the screen. See the image below.
- If you need to solve HDD password locked problem, you can run HDD\_PW.EXE
  1. Key in “hdd\_pw 15494 0”
  2. Select “2”
  3. Choose one of the uppercase strings
- Reboot the system and key in “OKJFN42” or “UVEIQ96” as your HDD user password.



# Machine Disassembly and Replacement

---

This chapter contains step-by-step procedures on how to disassemble the notebook computer for maintenance and troubleshooting.

## Disassembly Requirements

To disassemble the computer, you need the following tools:

- Wrist grounding strap and conductive mat for preventing electrostatic discharge
- Flat screwdriver
- Philips screwdriver
- Hex screwdriver
- Plastic flat screwdriver
- Plastic tweezers

**NOTE:** The screws for the different components vary in size. During the disassembly process, group the screws with the corresponding components to avoid mismatch when putting back the components.

---

# General Information

## Pre-disassembly Instructions

Before proceeding with the disassembly procedure, make sure that you do the following:

1. Turn off the power to the system and all peripherals.
2. Unplug the AC adapter and all power and signal cables from the system.



3. Place the system on a flat, stable surface.
4. Remove the battery pack.

## Disassembly Process

The disassembly process is divided into the following stages:

- External module disassembly
- Main unit disassembly
- LCD module disassembly

The flowcharts provided in the succeeding disassembly sections illustrate the entire disassembly sequence. Observe the order of the sequence to avoid damage to any of the hardware components. For example, if you want to remove the main board, you must first remove the keyboard, then disassemble the inside assembly frame in that order.

### Main Screw List

Item	Screw	Color	Part No.
A	M2.5 x L4	Black	86.00H59.734
B	M2 x L4	Silver	86.9A552.4R0
C	M2.5 x L6	Black	86.00E12.536
D	M2.5 x L10	Black	86.00F84.73A
E	M2.5 x L5	Black	86.00F87.735
F	M3 x L4	Silver	86.9A554.4R0
G	M2.5 x L3.5	Silver	86.9A536.3R5
H	M2 x L3	Silver	86.9A552.3R0

# External Module Disassembly Process

## External Modules Disassembly Flowchart

The flowchart below gives you a graphic representation on the entire disassembly sequence and instructs you on the components that need to be removed during servicing. For example, if you want to remove the main board, you must first remove the keyboard, then disassemble the inside assembly frame in that order.

### EXTERNAL MODULE DISASSEMBLY

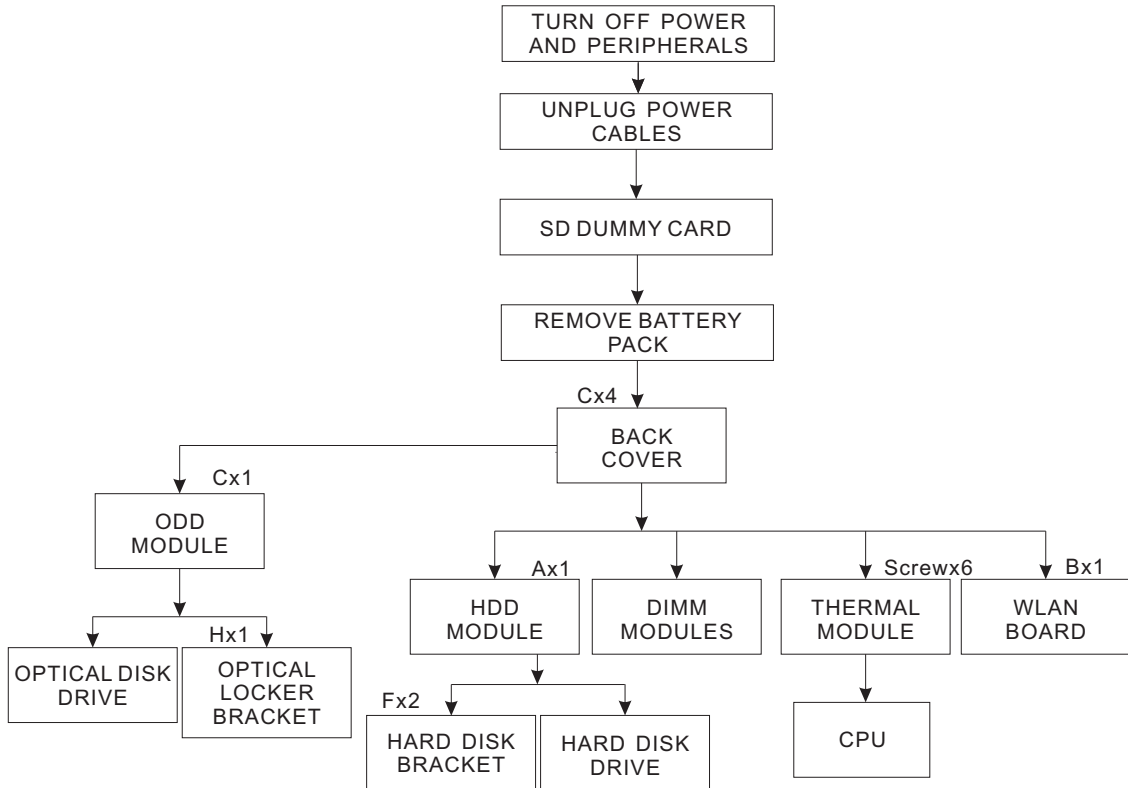

### Screw List

Item	Screw	Color	Part No.
A	M2.5 x L4	Black	86.00H59.734
B	M2 x L4	Silver	86.9A552.4R0
C	M2.5 x L6	Black	86.00E12.536
F	M3 x L4	Silver	86.9A554.4R0
G	M2.5 x L3.5	Silver	86.9A536.3R5
H	M2 x L3	Silver	86.9A552.3R0

---

## Removing the SD Dummy Card

1. Push the SD dummy card all the way in to eject it.



2. Pull it out from the slot.



---

## Removing the Battery Pack

1. See “Removing the SD Dummy Card” on page 44.
2. Turn the notebook over so the bottom is facing up.
3. Slide the battery lock/unlock latch to the unlock position.

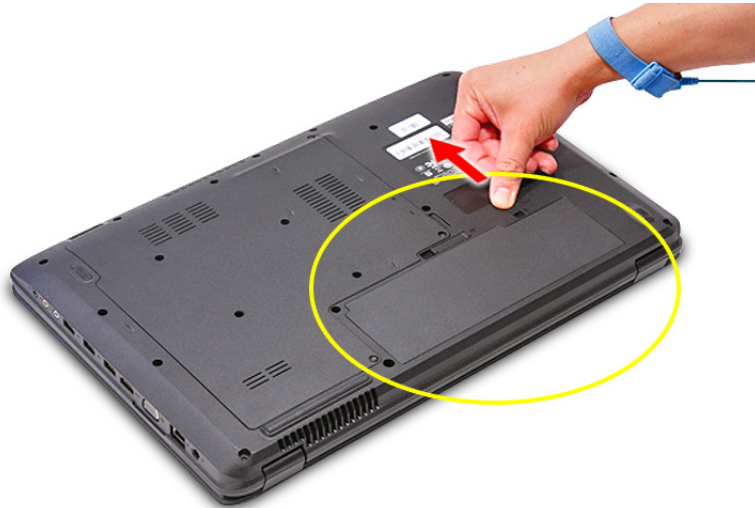

**Note:** Battery has been highlighted with the yellow circle as above image shows. Please detach the battery and follow local regulations for disposal.

4. Slide the battery release latch to the release position (a) to pop out the battery pack, then remove the battery pack from the main unit (b).

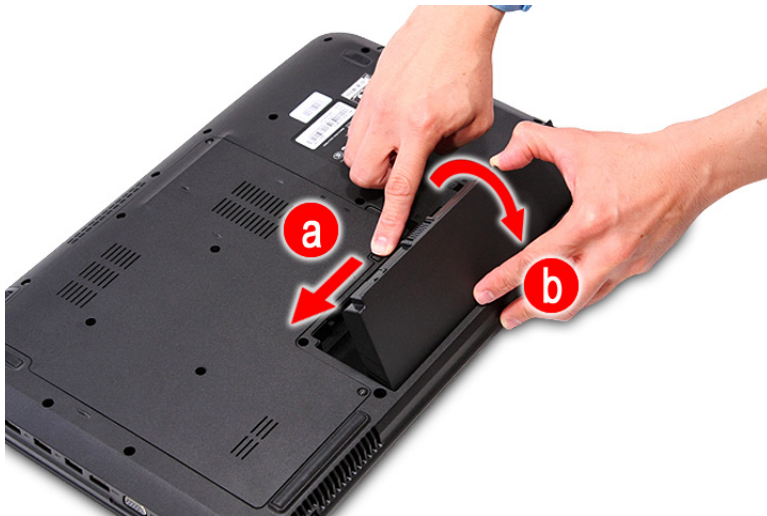

# Removing the Back Cover

- 1. See "Removing the SD Dummy Card" on page 44.
- 2. See "Removing the Battery Pack" on page 45.
- 3. Remove the four screws (C) on the back cover.



Size (Quantity)	Color	Torque	Part No.
M2.5 x L6 (4)	Black	3.0 kgf-cm	86.00E12.536

- 4. Remove the four captive screws on the back cover.

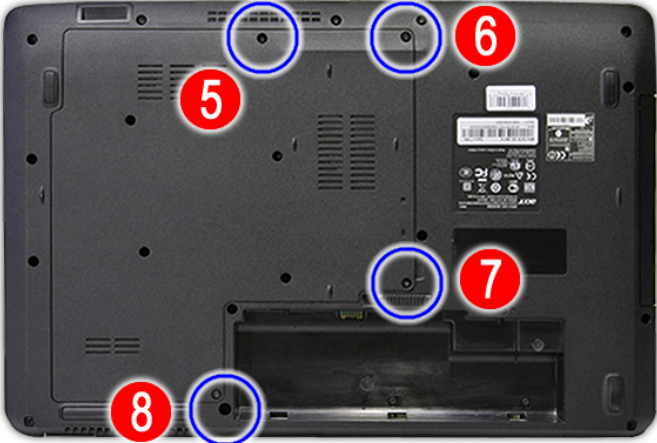

- 
5. Use a plastic screw driver to carefully pry open the back cover.



6. Carefully lift and remove the back cover.

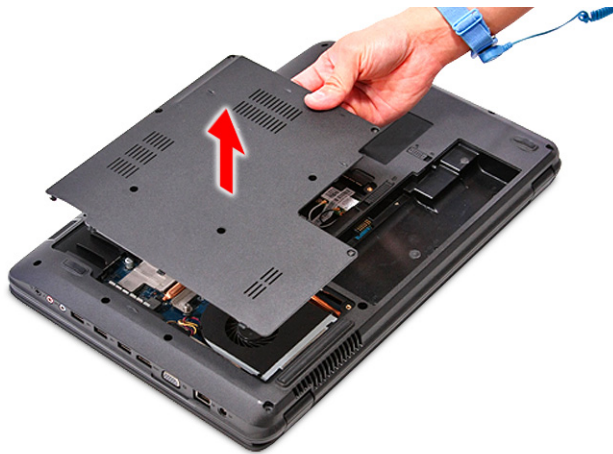

## Removing the Hard Disk Drive Module

1. See “Removing the SD Dummy Card” on page 44.
2. See “Removing the Battery Pack” on page 45.
3. See “Removing the Back Cover” on page 46.
4. Remove the one screw (A) securing the hard disk drive module to the system.



Size (Quantity)	Color	Torque	Part No.
M2.5 x L4 (1)	Black	3.0 kgf-cm	86.00H59.734

5. Pull the plastic tab in the direction indicated by the arrow to disengage the HDD module from the connector.





- Lift the HDD module and remove it from the HDD bay.



**NOTE:** To prevent damage to device, avoid pressing down on it or placing heavy objects on top of it.

- Remove the two screws (F) securing the hard disk to the bracket and remove the hard disk from the bracket.

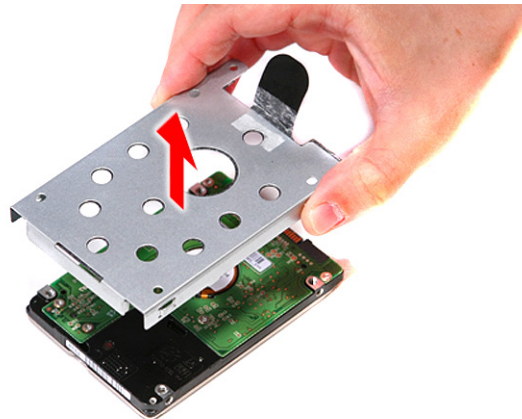
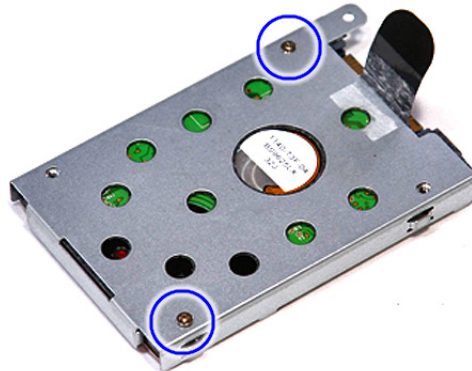

Size (Quantity)	Color	Torque	Part No.
M3 x L4 (2)	Silver	3.0 kgf-cm	86.9A554.4R0

## Removing the Wireless LAN Card

1. See “Removing the SD Dummy Card” on page 44.
2. See “Removing the Battery Pack” on page 45.
3. See “Removing the Back Cover” on page 46.
4. See “Removing the Hard Disk Drive Module” on page 48.
5. For 2-antenna WLAN card, detach the black cable from connector 1 and the white cable from connector 2 on the WLAN card.

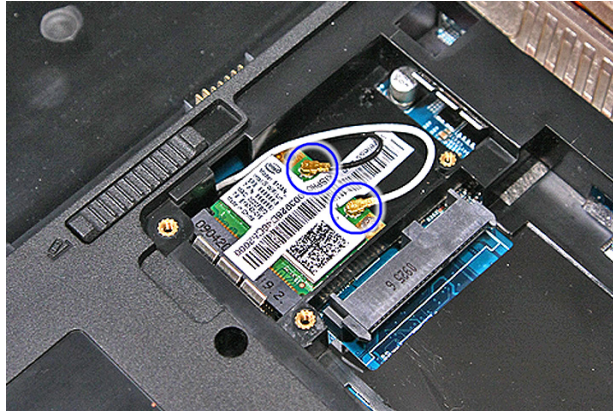

6. Remove the one screw (B) on the WLAN card and detach the card.



Size (Quantity)	Color	Torque	Part No.
M2 x L4 (1)	Silver	1.6 kgf-cm	86.9A552.4R0

7. Release the wireless LAN card from its connector and detach the card.



## Removing the DIMM Module

1. See “Removing the SD Dummy Card” on page 44.
2. See “Removing the Battery Pack” on page 45.
3. See “Removing the Back Cover” on page 46.
4. See “Removing the Hard Disk Drive Module” on page 48.
5. See “Removing the Wireless LAN Card” on page 50.
6. Push out the latches on both sides of the DIMM sockets to release the DIMMs.

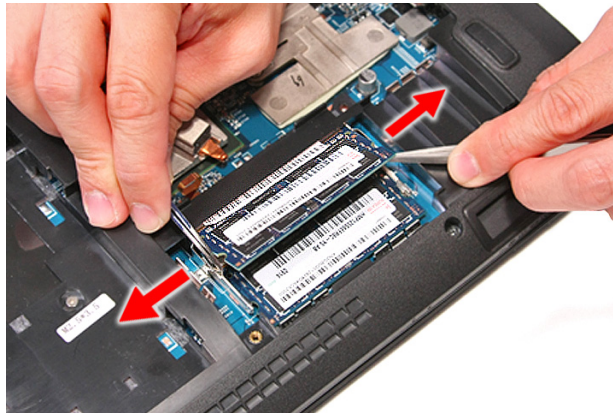

7. Remove the DIMM module(s).

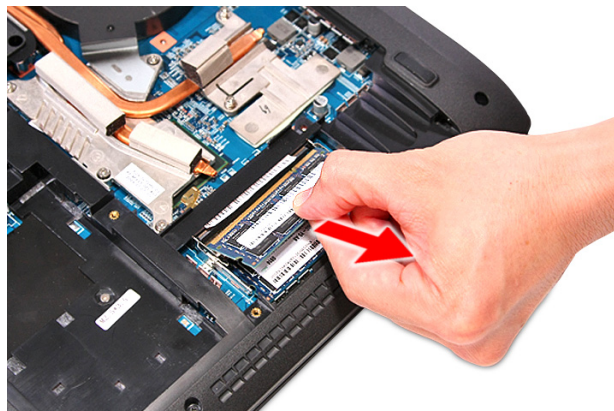

---

## Removing the Heatsink Module

**NOTE:** There are two version of heatsink module. For this section, we are going to use the Discrete model. The UMA version looks like the picture below:

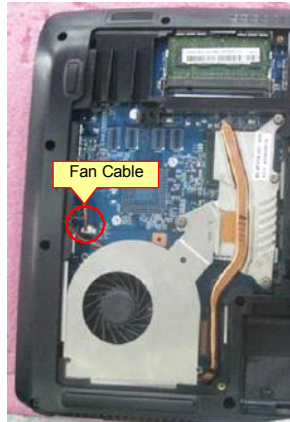

1. See "Removing the SD Dummy Card" on page 44.
2. See "Removing the Battery Pack" on page 45.
3. See "Removing the Back Cover" on page 46.
4. See "Removing the Hard Disk Drive Module" on page 48.
5. See "Removing the Wireless LAN Card" on page 50.
6. See "Removing the DIMM Module" on page 51.
7. Disconnect the fan cable connector from its connector on the main board.

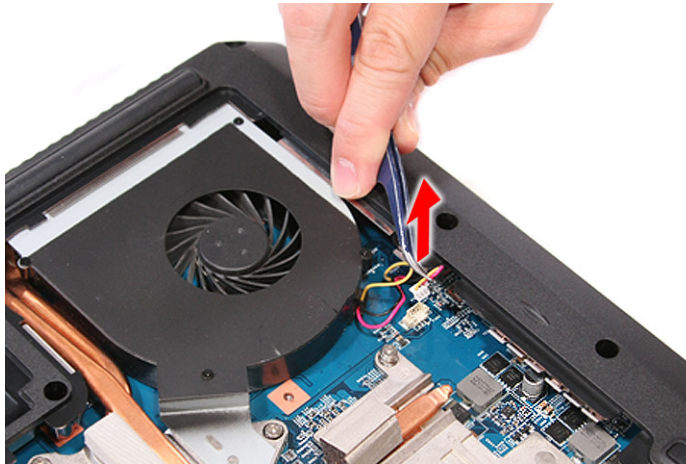

8. Loosen the six screws securing the heatsink module in the order shown.

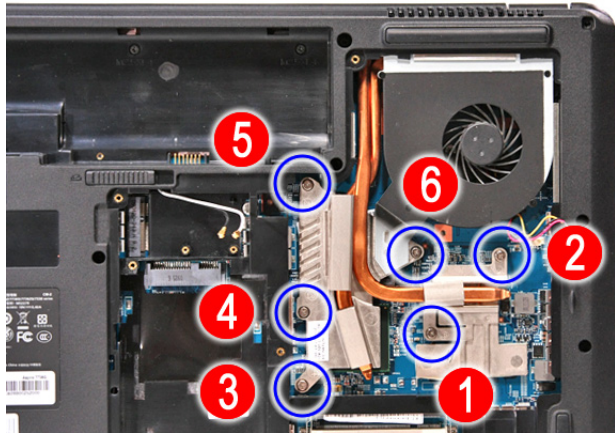

**NOTE:** For the UMA model, loosen the four screws securing the heatsink module in the order shown.

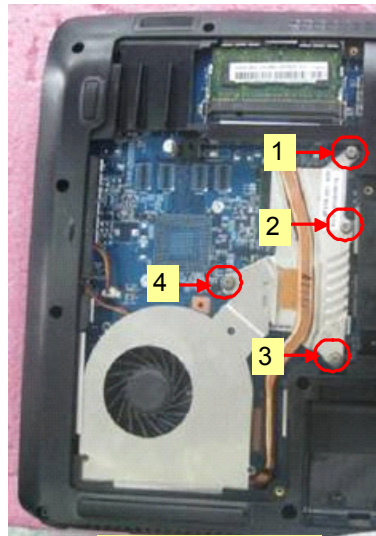

UMA

9. Carefully lift up the heatsink module.



---

## Removing the CPU

**NOTE:** Aspire 7736/7736Z/7336 Series uses the Intel® processor, while Aspire 7540 Series uses the AMD® processor. But the process in removing the CPU are the same for all the models.

1. See “Removing the SD Dummy Card” on page 44.
2. See “Removing the Battery Pack” on page 45.
3. See “Removing the Back Cover” on page 46.
4. See “Removing the Hard Disk Drive Module” on page 48.
5. See “Removing the Wireless LAN Card” on page 50.
6. See “Removing the DIMM Module” on page 51.
7. See “Removing the Heatsink Module” on page 52.
8. Using a flat screwdriver, turn the CPU socket latch counter-clockwise to release the CPU.

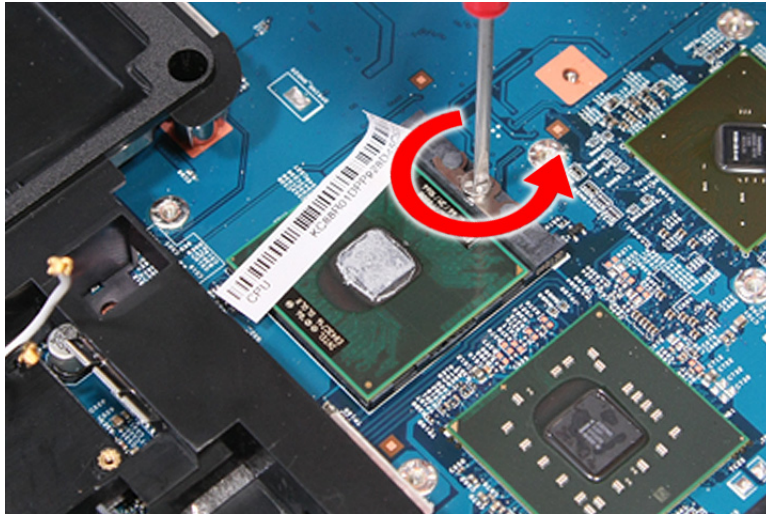

9. Lift up carefully to remove the CPU.

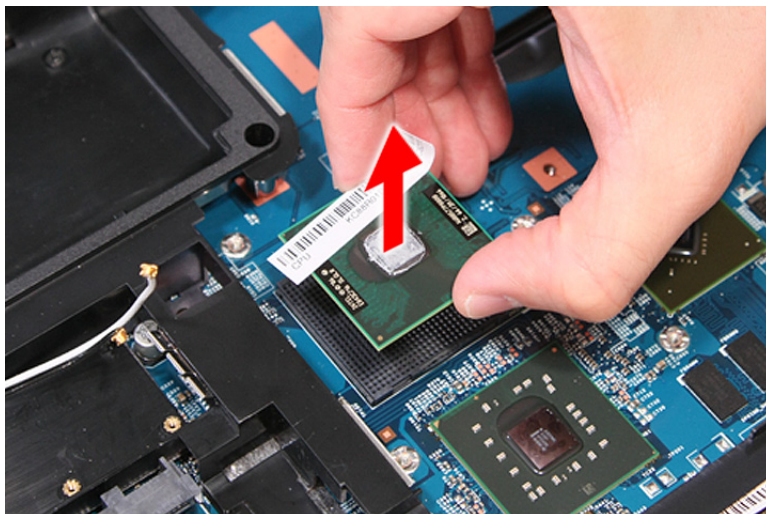

**NOTE:** When installing the CPU, make sure to install the CPU with Pin 1 at the corner as shown.

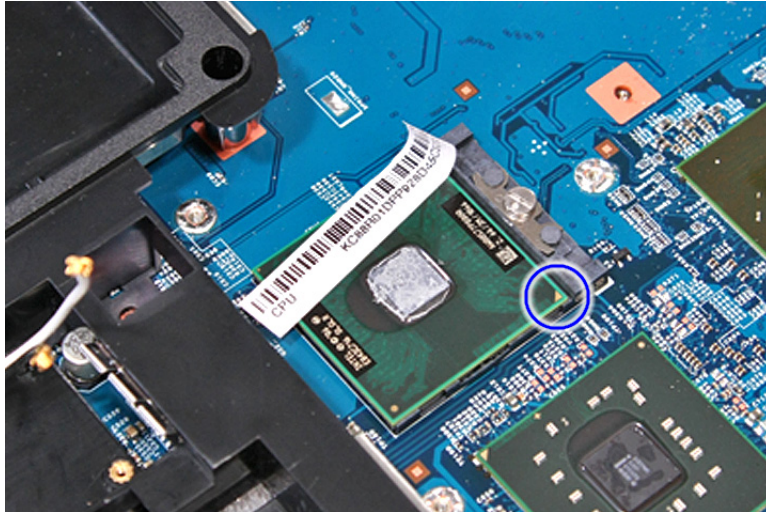

## Removing the Optical Drive Module

1. See “Removing the SD Dummy Card” on page 44.
2. See “Removing the Battery Pack” on page 45.
3. See “Removing the Back Cover” on page 46.
4. See “Removing the Hard Disk Drive Module” on page 48.
5. See “Removing the Wireless LAN Card” on page 50.
6. See “Removing the DIMM Module” on page 51.
7. See “Removing the Heatsink Module” on page 52.
8. See “Removing the CPU” on page 54.
9. Remove the one screw (C) securing the optical drive module to the system.

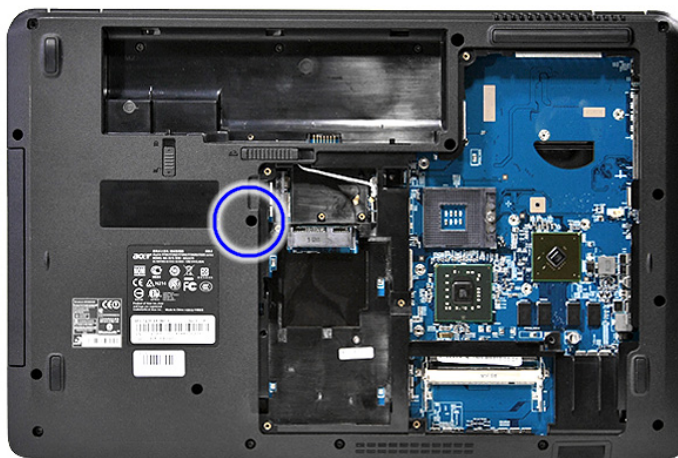

Size (Quantity)	Color	Torque	Part No.
M2.5 x L6 (1)	Black	3.0 kgf-cm	86.00E12.536

10. Slowly pull out the ODD module from the ODD drive bay.



11. Remove the one screw (H) securing the locker bracket and remove the locker bracket from the optical disk drive module.

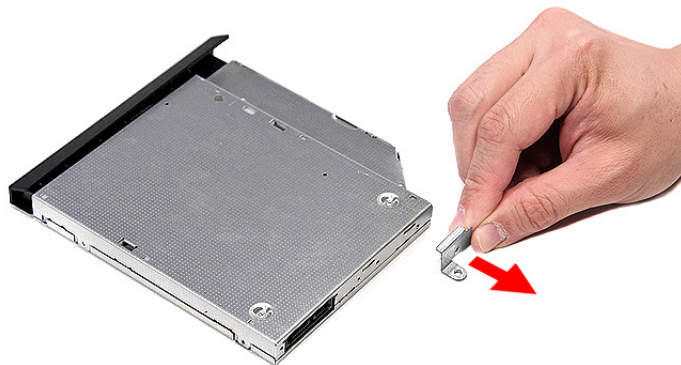

Size (Quantity)	Color	Torque	Part No.
M2 x L3 (1)	Silver	1.6 kgf-cm	86.9A552.3R0



# Main Unit Disassembly Process

## Main Unit Disassembly Flowchart

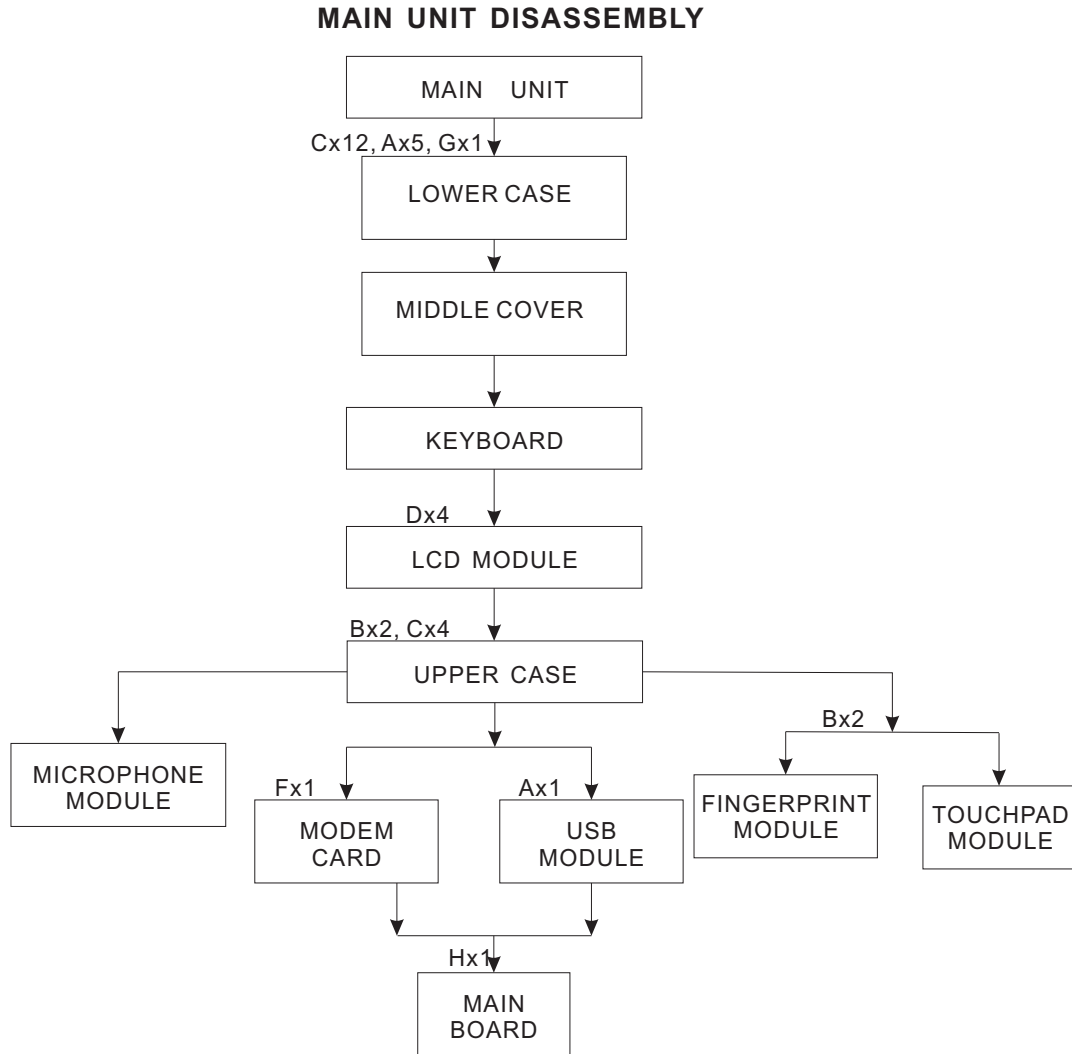

### Screw List

Item	Screw	Color	Part No.
A	M2.5 x L4	Black	86.00H59.734
B	M2 x L4	Silver	86.9A552.4R0
C	M2.5 x L6	Black	86.00E12.536
G	M2.5 x L3.5	Silver	86.9A536.3R5
H	M2 x L3	Silver	86.9A552.3R0

# Removing the Middle Cover

1. See “Removing the SD Dummy Card” on page 44.
2. See “Removing the Battery Pack” on page 45.
3. See “Removing the Back Cover” on page 46.
4. See “Removing the Hard Disk Drive Module” on page 48.
5. See “Removing the Wireless LAN Card” on page 50.
6. See “Removing the DIMM Module” on page 51.
7. See “Removing the Heatsink Module” on page 52.
8. See “Removing the CPU” on page 54.
9. See “Removing the Optical Drive Module” on page 55.
10. Remove the twelve (C) from the lower case.

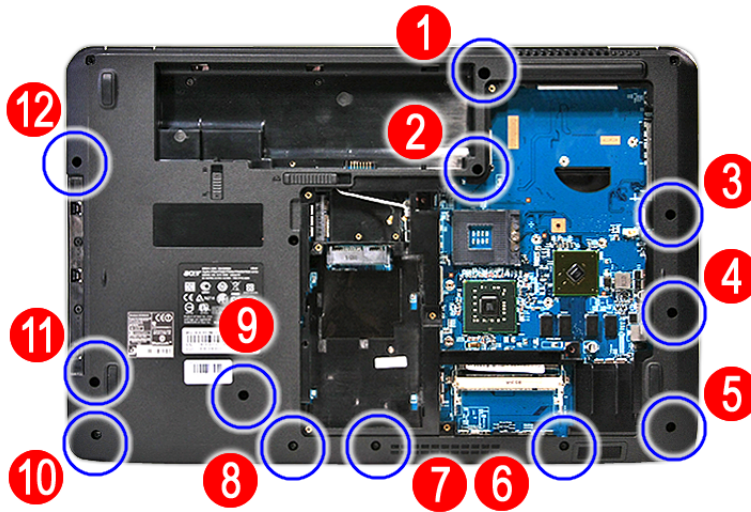

Size (Quantity)	Color	Torque	Part No.
M2.5 x L6 (11)	Black	3.0 kgf-cm	86.00E12.536

11. Remove the five screws (A) from the lower case.

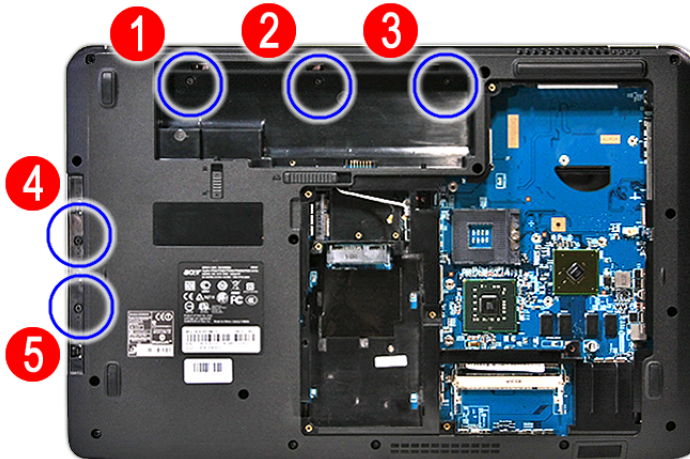

Size (Quantity)	Color	Torque	Part No.
M2.5 x L4 (5)	Black	3.0 kgf-cm	86.00H59.734

12. Remove the one screw (G) from the lower case.

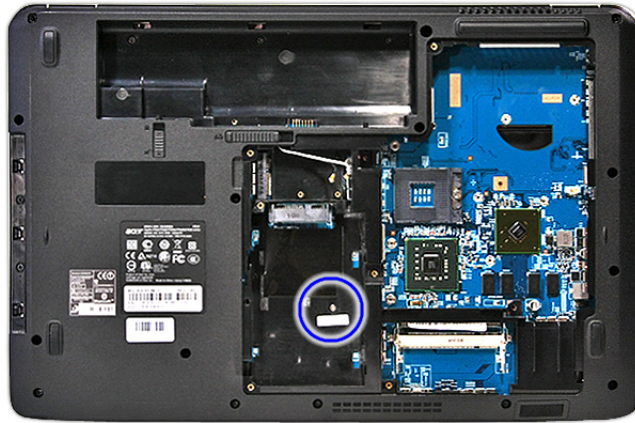

Size (Quantity)	Color	Torque	Part No.
M2.5 x L3.5 (1)	Silver	3.0 kgf-cm	86.9A536.3R5

13. Turn the notebook over so the top is facing up. Open the LCD panel.

14. Carefully pry and lift the middle cover.



---

## Removing the Keyboard

1. See “Removing the SD Dummy Card” on page 44.
2. See “Removing the Battery Pack” on page 45.
3. See “Removing the Back Cover” on page 46.
4. See “Removing the Hard Disk Drive Module” on page 48.
5. See “Removing the Wireless LAN Card” on page 50.
6. See “Removing the DIMM Module” on page 51.
7. See “Removing the Heatsink Module” on page 52.
8. See “Removing the CPU” on page 54.
9. See “Removing the Optical Drive Module” on page 55.
10. See “Removing the Middle Cover” on page 58.
11. Release the keyboard from the latches.

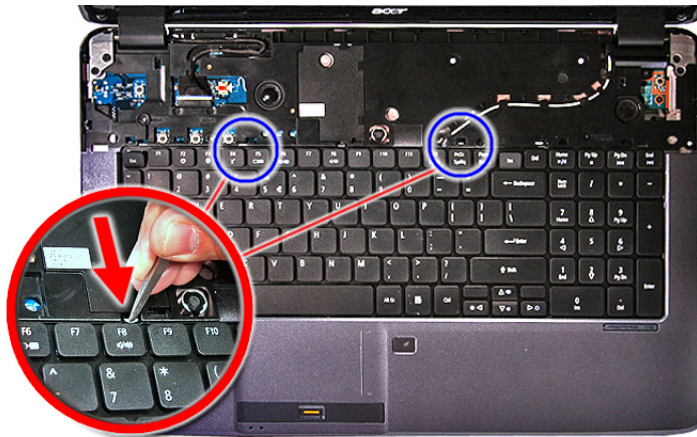

12. Turn it over on the touchpad area.

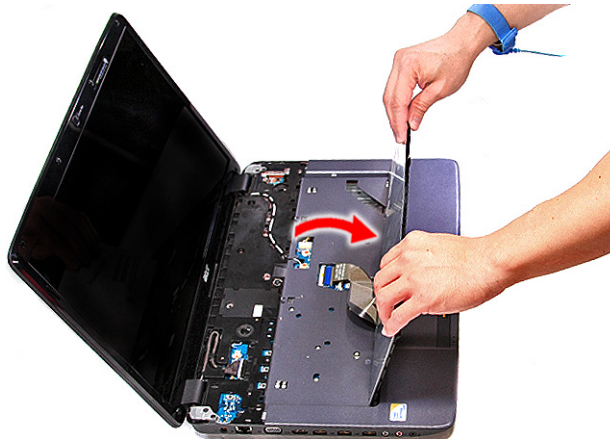

13. Release the latch (a) and disconnect the keyboard cable (b) from its connector on the main board and detach the keyboard.

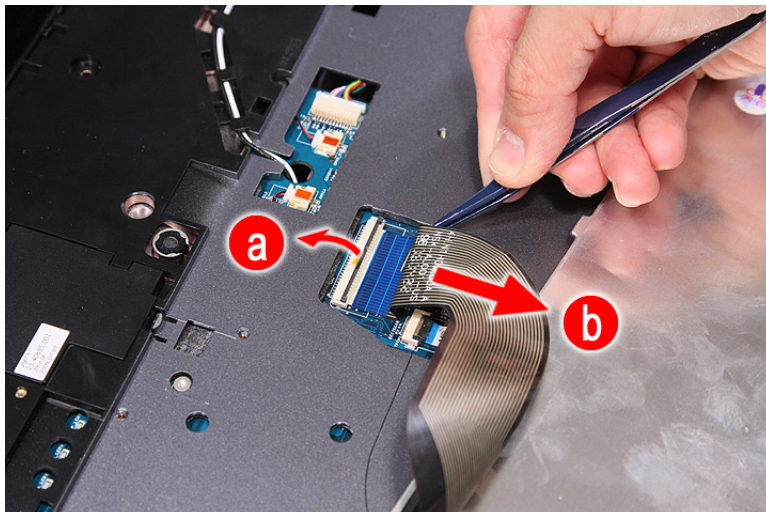

## Removing the LCD Module

1. See “Removing the SD Dummy Card” on page 44.
2. See “Removing the Battery Pack” on page 45.
3. See “Removing the Back Cover” on page 46.
4. See “Removing the Hard Disk Drive Module” on page 48.
5. See “Removing the Wireless LAN Card” on page 50.
6. See “Removing the DIMM Module” on page 51.
7. See “Removing the Heatsink Module” on page 52.
8. See “Removing the CPU” on page 54.
9. See “Removing the Optical Drive Module” on page 55.
10. See “Removing the Middle Cover” on page 58.
11. See “Removing the Keyboard” on page 60.
12. Release the wireless antenna cables from the latches and carefully pull out the wireless antenna cables from the hole..



13. Remove the LCD cable from its connector on the main board and release the cable from the latches.



14. Remove the four screws (D) from the left and right hinges.

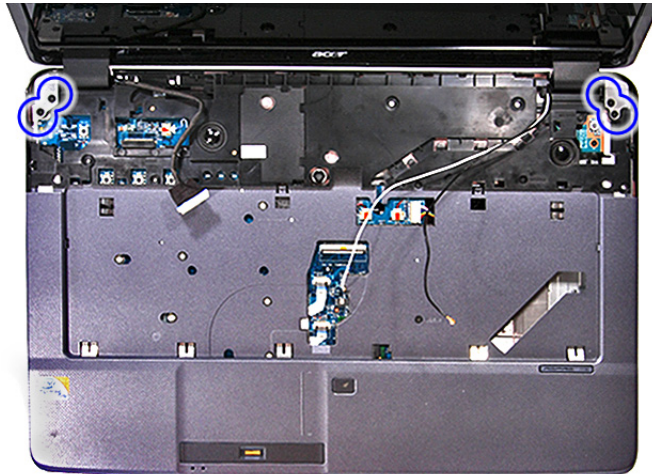

Size (Quantity)	Color	Torque	Part No.
M2.5 x L10 (4)	Black	3.0 kgf-cm	86.00F84.73A

15. Carefully remove the LCD module from the base unit.



**NOTE:** When connecting the cables back to the unit, please note that the cables should be routed well.

## Separating the Upper Case from the Lower Case

1. See “Removing the SD Dummy Card” on page 44.
2. See “Removing the Battery Pack” on page 45.
3. See “Removing the Back Cover” on page 46.
4. See “Removing the Hard Disk Drive Module” on page 48.
5. See “Removing the Wireless LAN Card” on page 50.
6. See “Removing the DIMM Module” on page 51.
7. See “Removing the Heatsink Module” on page 52.
8. See “Removing the CPU” on page 54.
9. See “Removing the Optical Drive Module” on page 55.
10. See “Removing the Middle Cover” on page 58.
11. See “Removing the Keyboard” on page 60.
12. See “Removing the LCD Module” on page 61.
13. Release the latch (a) and disconnect the fingerprint cable (b) from its connector on the main board.

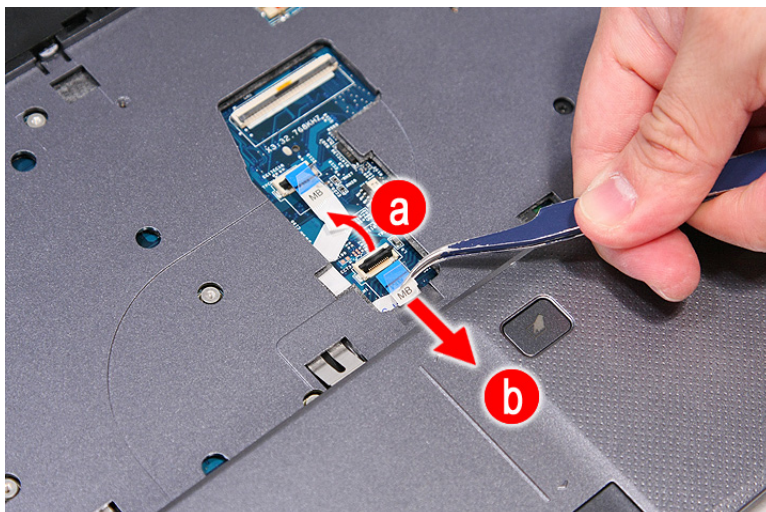

14. Release the latch (a) and disconnect the touchpad cable (B) from its connector on the main board.

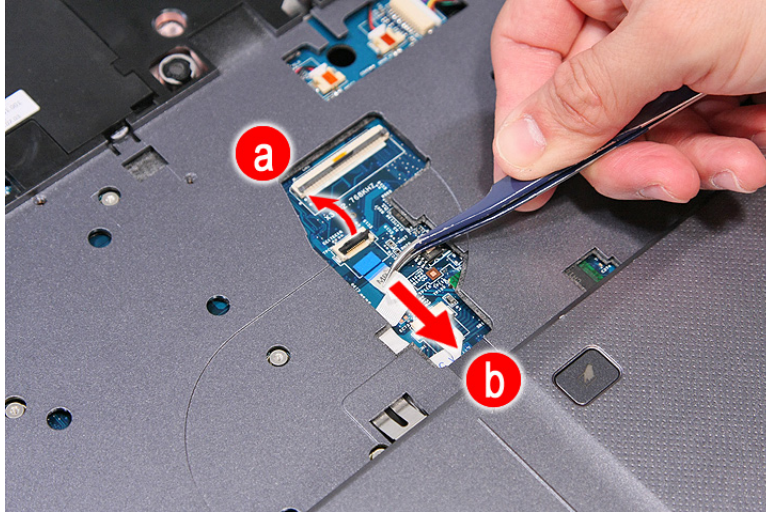

15. Disconnect the left speaker cable from its connector on the main board.

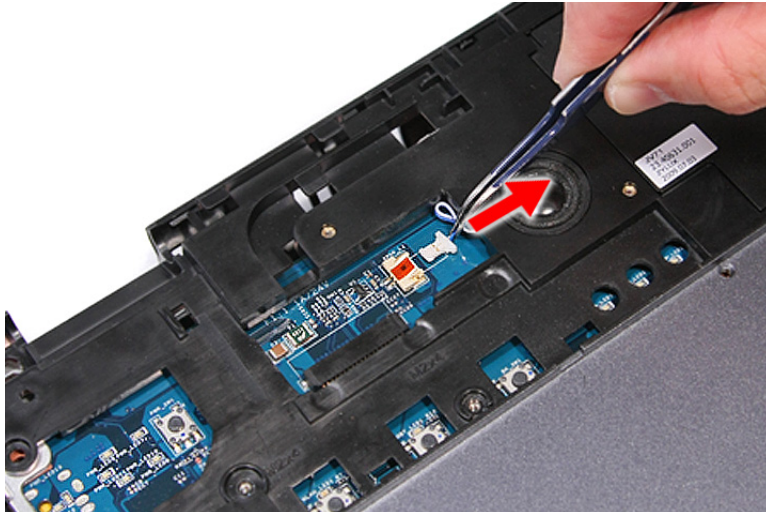



16. Remove the two screws (B) securing the upper case to the system.

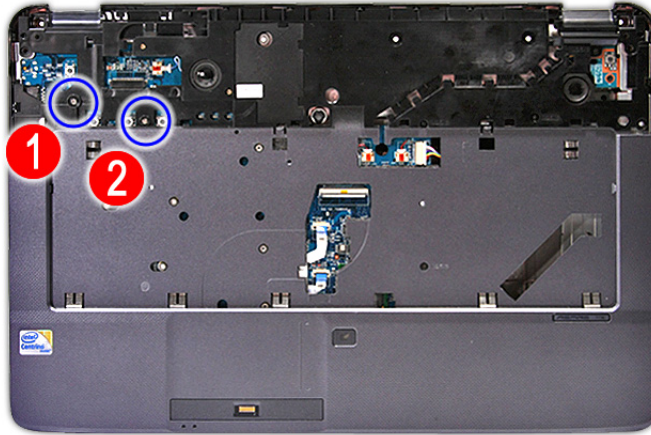

Size (Quantity)	Color	Torque	Part No.
M2 x L4 (2)	Silver	1.6 kgf-cm	86.9A552.4R0

17. Remove the four screws (C) securing the upper case to the system.

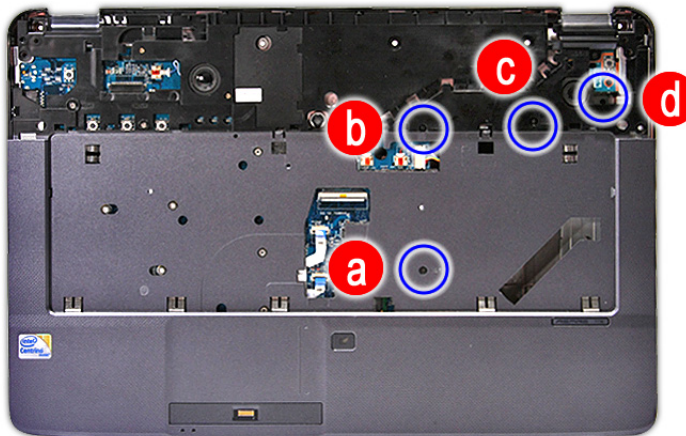

Size (Quantity)	Color	Torque	Part No.
M2.5 x L6 (4)	Black	3.0 kgf-cm	86.00E12.536

18. Gently lift and detach the upper case from the lower case.

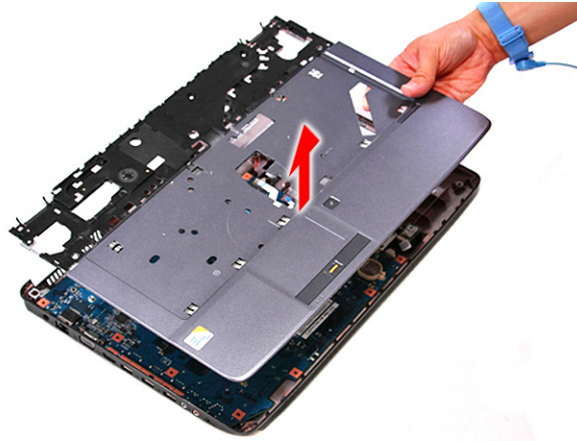

## Removing the Fingerprint/Button and Touchpad Boards

1. See “Removing the SD Dummy Card” on page 44.
2. See “Removing the Battery Pack” on page 45.
3. See “Removing the Back Cover” on page 46.
4. See “Removing the Hard Disk Drive Module” on page 48.
5. See “Removing the Wireless LAN Card” on page 50.
6. See “Removing the DIMM Module” on page 51.
7. See “Removing the Heatsink Module” on page 52.
8. See “Removing the CPU” on page 54.
9. See “Removing the Optical Drive Module” on page 55.
10. See “Removing the Middle Cover” on page 58.
11. See “Removing the Keyboard” on page 60.
12. See “Removing the LCD Module” on page 61.
13. See “Separating the Upper Case from the Lower Case” on page 63.
14. Release the latch (a) and disconnect the fingerprint/ button cable (b) from the fingerprint/ button board.

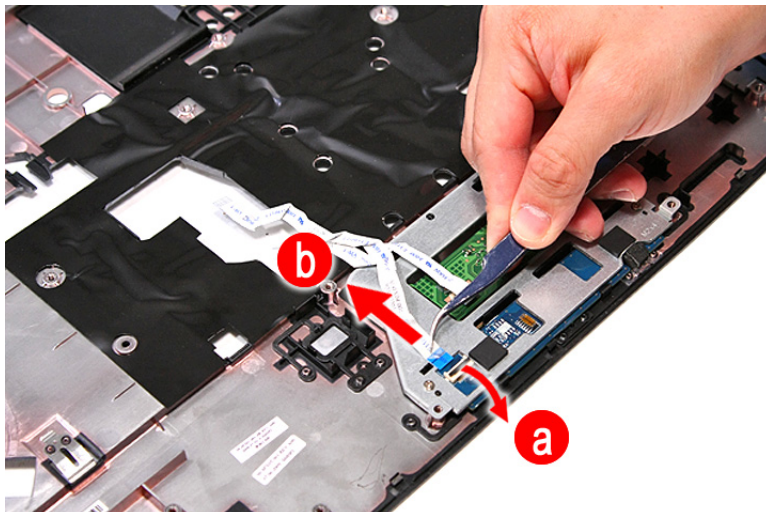

15. Detach the fingerprint/ button cable and touchpad cable from the upper case.

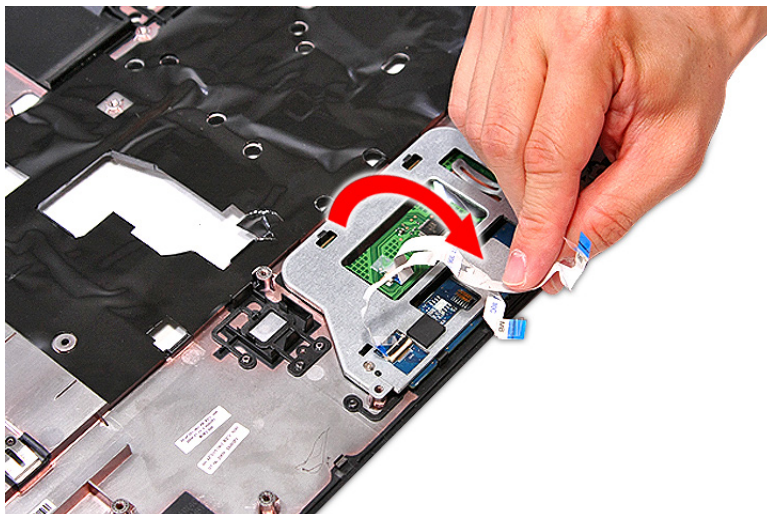

16. Release the latch (a) and disconnect the touchpad cable (b) from the touchpad board.

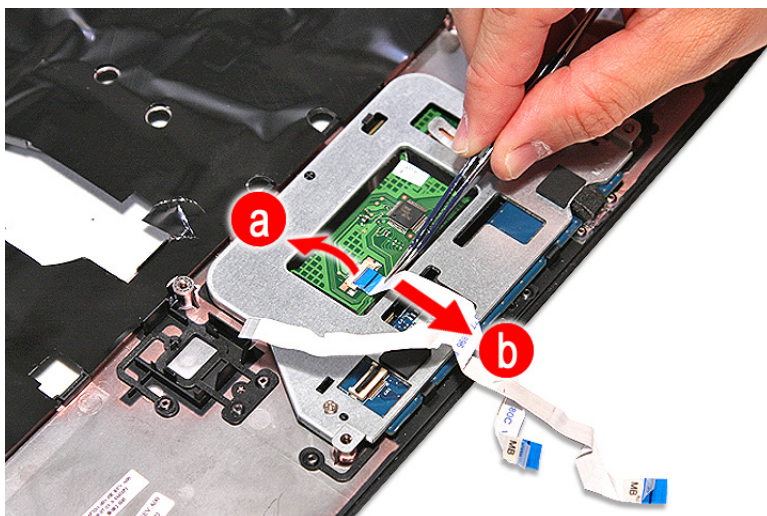

17. Remove the two screws (B) securing the touchpad and fingerprint/button bracket to the upper case.

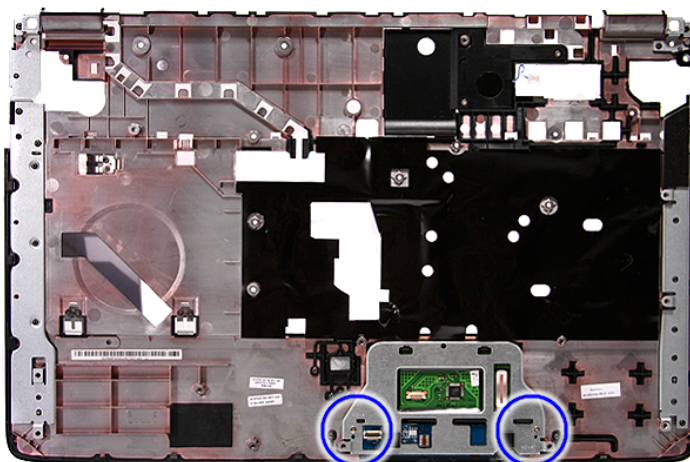

Size (Quantity)	Color	Torque	Part No.
M2 x L4 (2)	Silver	1.6 kgf-cm	86.9A552.4R0

18. Lift and detach the touchpad and fingerprint/button bracket.

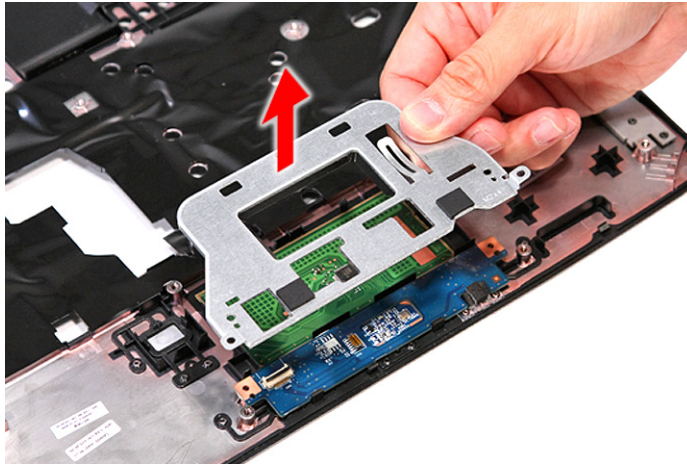

19. Detach the fingerprint/button board.

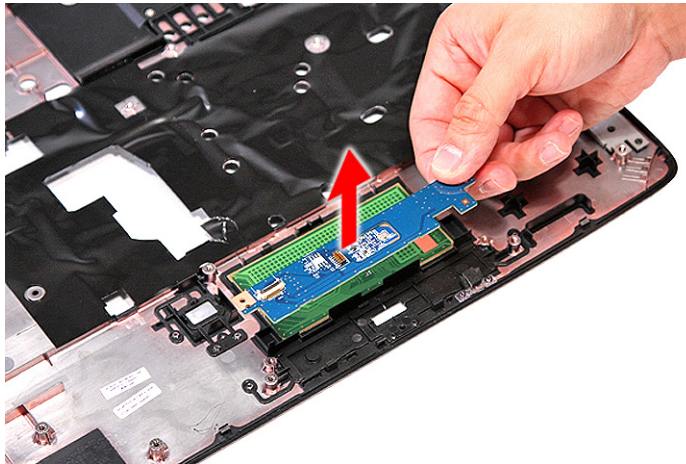

20. Pry to loosen the touchpad board and detach the touchpad board from the upper case.

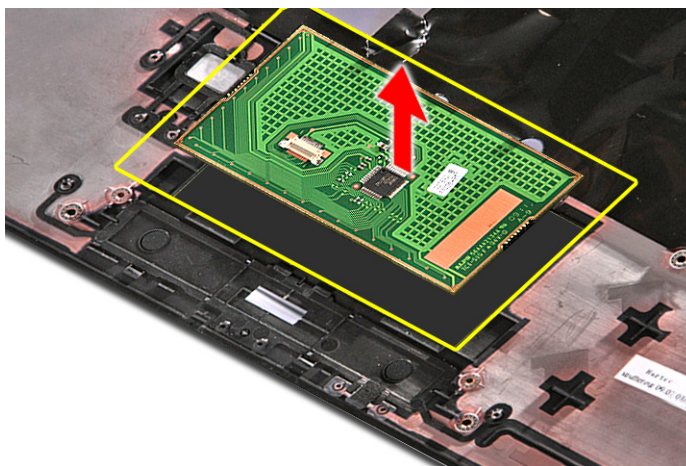

**WARNING:** The touchpad board is glued to the upper case, only remove the touchpad board if it is defective.



**Note:** Circuit boards > 10cm<sup>2</sup> has been highlighted with the yellow square as shown in the figure above. Please detach the circuit boards and follow the local regulations for disposal.

---

## Removing the USB Board Module

1. See “Removing the SD Dummy Card” on page 44.
2. See “Removing the Battery Pack” on page 45.
3. See “Removing the Back Cover” on page 46.
4. See “Removing the Hard Disk Drive Module” on page 48.
5. See “Removing the Wireless LAN Card” on page 50.
6. See “Removing the DIMM Module” on page 51.
7. See “Removing the Heatsink Module” on page 52.
8. See “Removing the Optical Drive Module” on page 55.
9. See “Removing the CPU” on page 54.
10. See “Removing the Middle Cover” on page 58.
11. See “Removing the Keyboard” on page 60.
12. See “Removing the LCD Module” on page 61.
13. See “Separating the Upper Case from the Lower Case” on page 63.
14. See “Removing the Fingerprint/Button and Touchpad Boards” on page 66.
15. Disconnect the USB cable from its connector on the main board and release the cable from the latches.

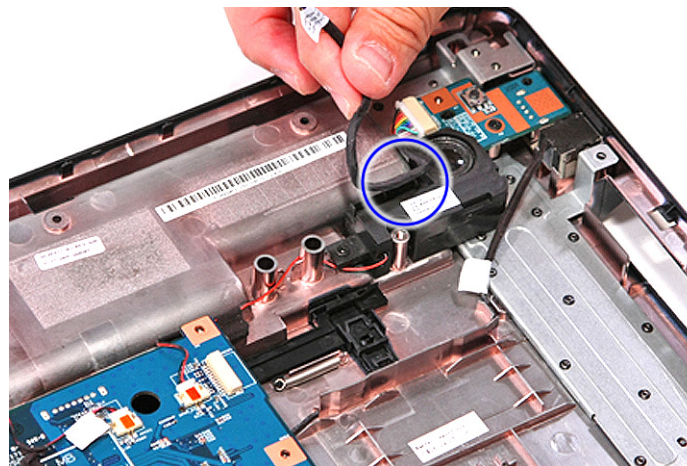
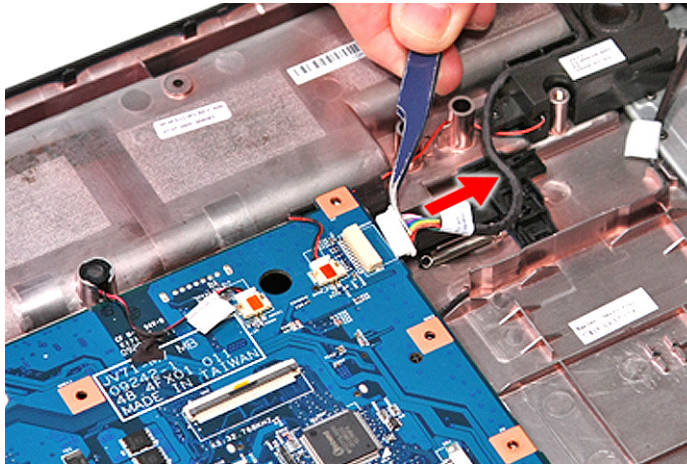

16. Remove the one screw (A) securing the USB board to the lower case.

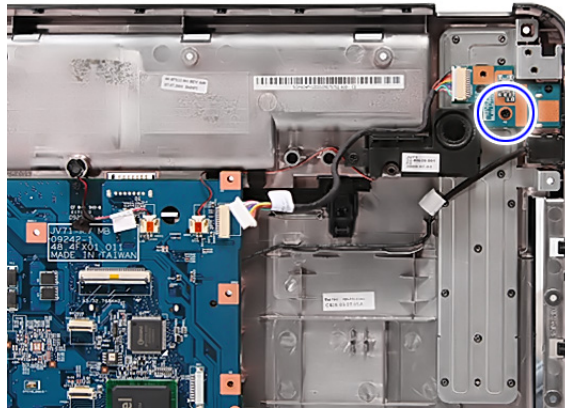

Size (Quantity)	Color	Torque	Part No.
M2.5 x L4 (1)	Black	3.0 kgf-cm	86.00H59.734

17. Remove the USB board module from the lower case.

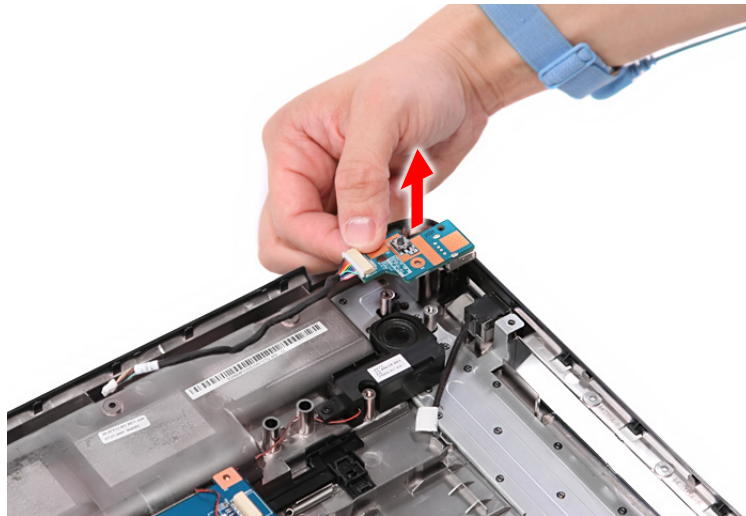

---

## Removing the Modem Board

1. See “Removing the SD Dummy Card” on page 44.
2. See “Removing the Battery Pack” on page 45.
3. See “Removing the Back Cover” on page 46.
4. See “Removing the Hard Disk Drive Module” on page 48.
5. See “Removing the Wireless LAN Card” on page 50.
6. See “Removing the DIMM Module” on page 51.
7. See “Removing the Heatsink Module” on page 52.
8. See “Removing the CPU” on page 54.
9. See “Removing the Optical Drive Module” on page 55.
10. See “Removing the Middle Cover” on page 58.
11. See “Removing the Keyboard” on page 60.
12. See “Removing the LCD Module” on page 61.
13. See “Separating the Upper Case from the Lower Case” on page 63.
14. See “Removing the Fingerprint/Button and Touchpad Boards” on page 66.
15. See “Removing the USB Board Module” on page 69.
16. Disconnect the modem cable from its connector on the main board.

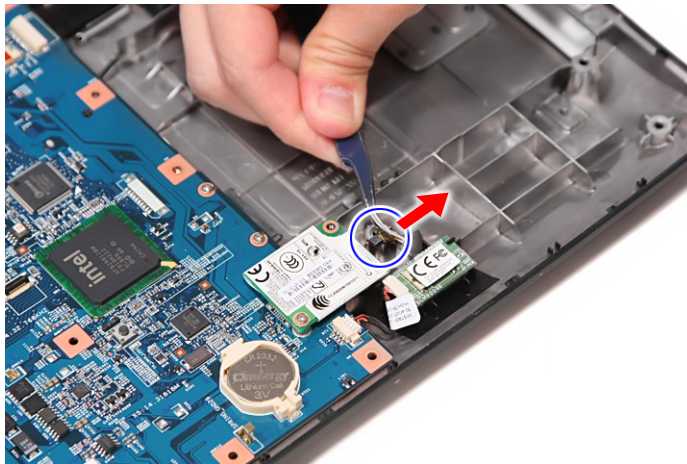

17. Remove the one screw (??) on the modem board and detach the modem board.



- 
18. Remove the modem board module from the main board.



## Removing the Bluetooth Board

1. See “Removing the SD Dummy Card” on page 44.
2. See “Removing the Battery Pack” on page 45.
3. See “Removing the Back Cover” on page 46.
4. See “Removing the Hard Disk Drive Module” on page 48.
5. See “Removing the Wireless LAN Card” on page 50.
6. See “Removing the DIMM Module” on page 51.
7. See “Removing the Heatsink Module” on page 52.
8. See “Removing the CPU” on page 54.
9. See “Removing the Optical Drive Module” on page 55.
10. See “Removing the Middle Cover” on page 58.
11. See “Removing the Keyboard” on page 60.
12. See “Removing the LCD Module” on page 61.
13. See “Separating the Upper Case from the Lower Case” on page 63.
14. See “Removing the Fingerprint/Button and Touchpad Boards” on page 66.
15. See “Removing the USB Board Module” on page 69.
16. See “Removing the Modem Board” on page 71.



---

17. Disconnect the bluetooth cable from its connector on the main board.



18. Detach the bluetooth card.



## Removing the Microphone Module

1. See “Removing the SD Dummy Card” on page 44.
2. See “Removing the Battery Pack” on page 45.
3. See “Removing the Back Cover” on page 46.
4. See “Removing the Hard Disk Drive Module” on page 48.
5. See “Removing the Wireless LAN Card” on page 50.
6. See “Removing the DIMM Module” on page 51.
7. See “Removing the Heatsink Module” on page 52.
8. See “Removing the CPU” on page 54.
9. See “Removing the Optical Drive Module” on page 55.
10. See “Removing the Middle Cover” on page 58.
11. See “Removing the Keyboard” on page 60.
12. See “Removing the LCD Module” on page 61.
13. See “Separating the Upper Case from the Lower Case” on page 63.
14. See “Removing the Fingerprint/Button and Touchpad Boards” on page 66.
15. See “Removing the USB Board Module” on page 69.
16. See “Removing the Modem Board” on page 71.
17. See “Removing the Bluetooth Board” on page 72.
18. Disconnect the microphone cable from its connector on the main board.

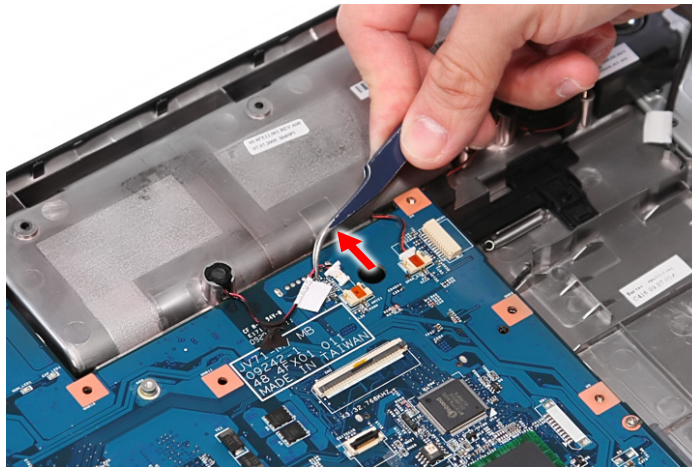

19. Detach the microphone module.

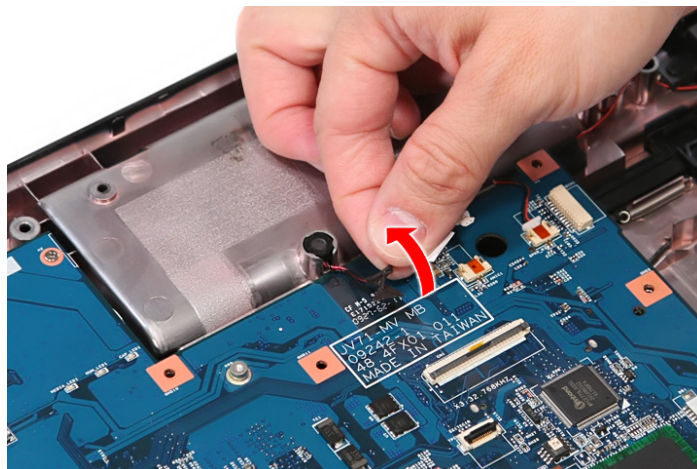

---

## Removing the Main Board

1. See “Removing the SD Dummy Card” on page 44.
2. See “Removing the Battery Pack” on page 45.
3. See “Removing the Back Cover” on page 46.
4. See “Removing the Hard Disk Drive Module” on page 48.
5. See “Removing the Wireless LAN Card” on page 50.
6. See “Removing the DIMM Module” on page 51.
7. See “Removing the Heatsink Module” on page 52.
8. See “Removing the CPU” on page 54.
9. See “Removing the Optical Drive Module” on page 55.
10. See “Removing the Middle Cover” on page 58.
11. See “Removing the Keyboard” on page 60.
12. See “Removing the LCD Module” on page 61.
13. See “Separating the Upper Case from the Lower Case” on page 63.
14. See “Removing the Fingerprint/Button and Touchpad Boards” on page 66.
15. See “Removing the USB Board Module” on page 69.
16. See “Removing the Modem Board” on page 71.
17. See “Removing the Bluetooth Board” on page 72.
18. See “Removing the Microphone Module” on page 74.
19. Disconnect the right speaker cable from its connector on the main board.

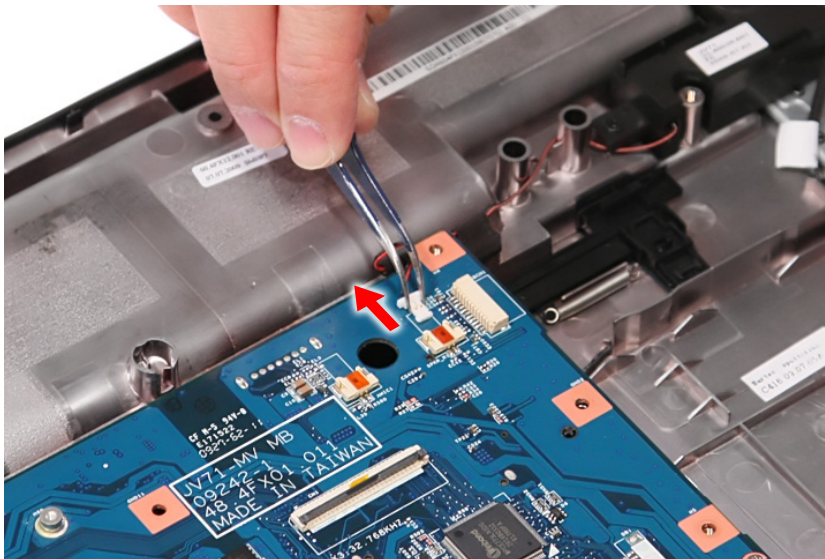

20. Remove the one screw (H) securing the main board in place.

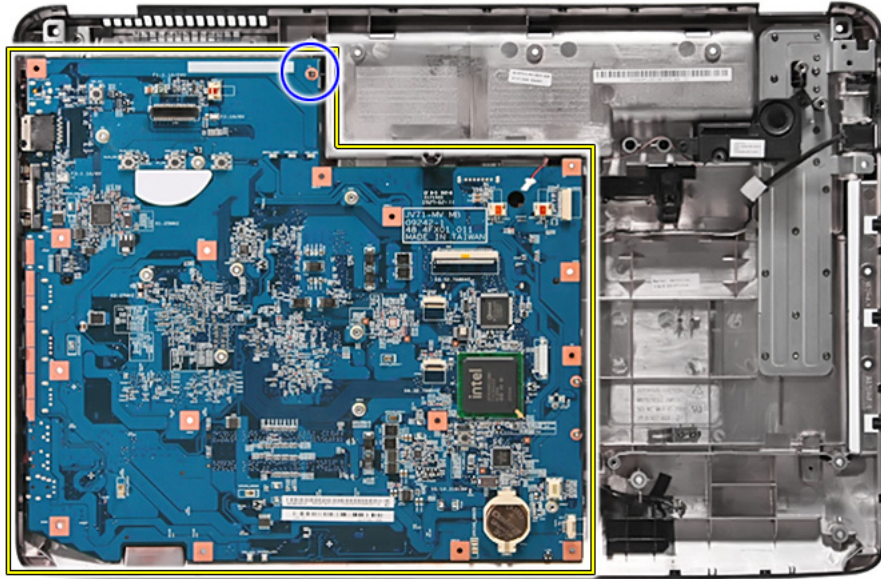

Size (Quantity)	Color	Torque	Part No.
M2 x L3 (1)	Silver	1.6 kgf-cm	86.9A552.3R0



**Note:** RTC battery has been highlighted with the yellow circle as shown in the figure above. Please detach the RTC battery and follow local regulations for disposal.



**Note:** Circuit boards > 10cm<sup>2</sup> has been highlighted with the yellow square as shown in the figure above. Please detach the circuit boards and follow the local regulations for disposal.

21. Lift the main board gently and remove it carefully from the lower case..

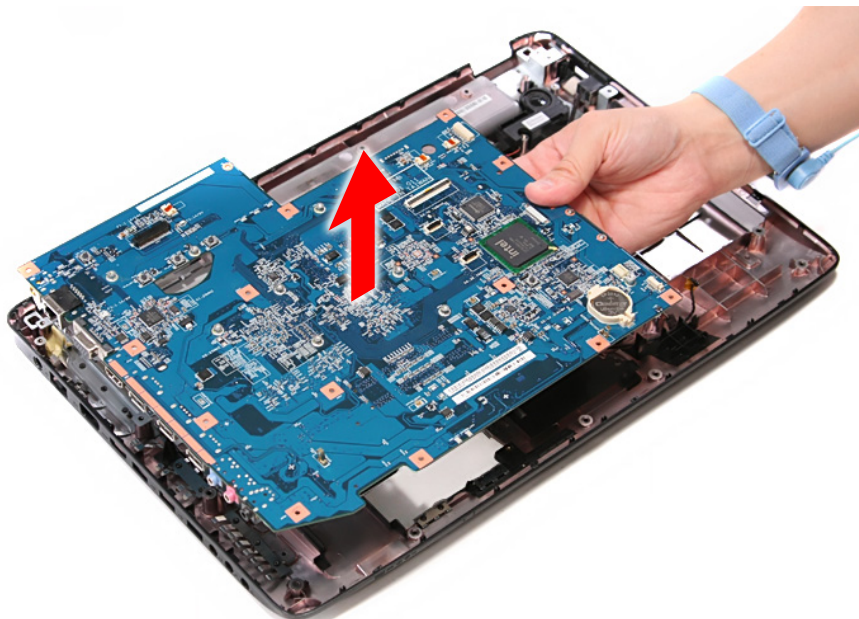

# LCD Module Disassembly Process

## LCD Module Disassembly Flowchart

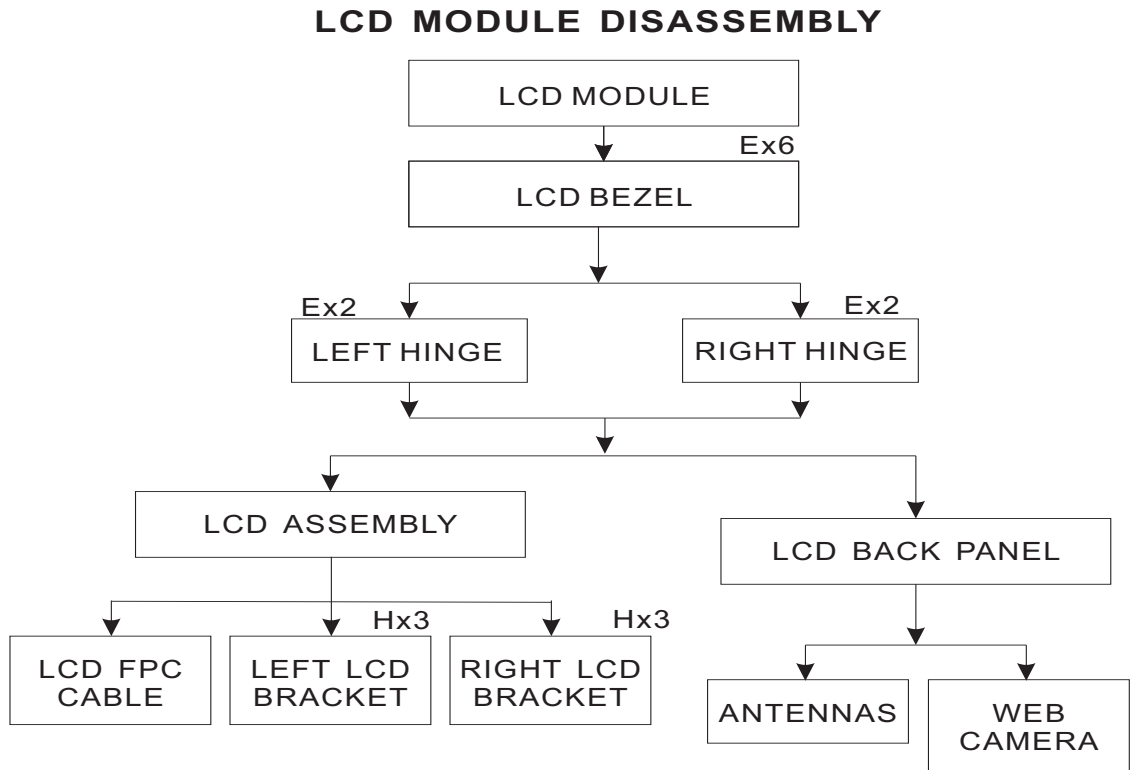

### Screw List

Item	Screw	Color	Part No.
E	M2.5 x L5 (6)	Black	86.00F87.735
H	M2 x L3	Silver	86.9A552.3R0

## Removing the LCD Bezel

1. See “Removing the SD Dummy Card” on page 44.
2. See “Removing the Battery Pack” on page 45.
3. See “Removing the Back Cover” on page 46.
4. See “Removing the Hard Disk Drive Module” on page 48.
5. See “Removing the Wireless LAN Card” on page 50.
6. See “Removing the DIMM Module” on page 51.
7. See “Removing the Heatsink Module” on page 52.
8. See “Removing the CPU” on page 54.
9. See “Removing the Optical Drive Module” on page 55.
10. See “Removing the Middle Cover” on page 58.
11. See “Removing the Keyboard” on page 60.
12. See “Removing the LCD Module” on page 61.
13. Remove the six screw covers on the LCD bezel.



14. Remove the six screws (E) on the LCD bezel . .



Size (Quantity)	Color	Torque	Part No.
M2.5 x L5 (6)	Black	3.0 kgf-cm	86.00F87.735

15. Carefully pry open the LCD bezel and remove it from the LCD panel.



## Removing the LCD panel with the Brackets

1. See "Removing the SD Dummy Card" on page 44.
2. See "Removing the Battery Pack" on page 45.
3. See "Removing the Back Cover" on page 46.
4. See "Removing the Hard Disk Drive Module" on page 48.
5. See "Removing the Wireless LAN Card" on page 50.
6. See "Removing the DIMM Module" on page 51.
7. See "Removing the Heatsink Module" on page 52.
8. See "Removing the CPU" on page 54.
9. See "Removing the Optical Drive Module" on page 55.
10. See "Removing the Middle Cover" on page 58.
11. See "Removing the Keyboard" on page 60.
12. See "Removing the LCD Module" on page 61.
13. See "Removing the LCD Bezel" on page 78.

14. Remove the four screws (E) on the left and right hinges as shown.

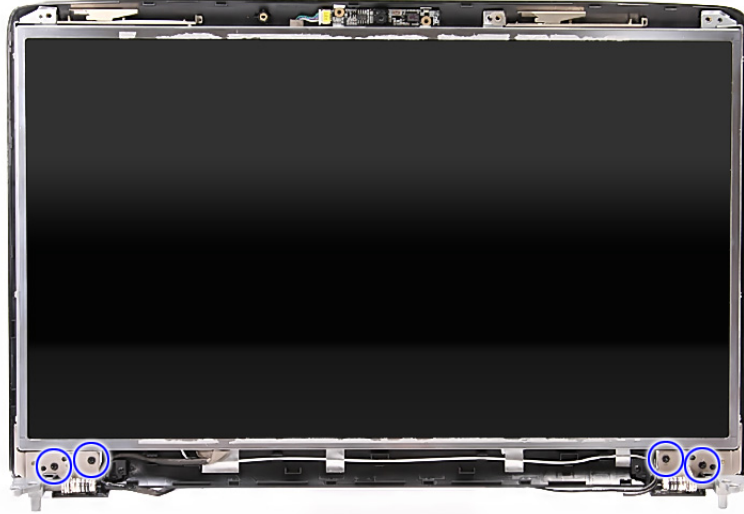

Size (Quantity)	Color	Torque	Part No.
M2.5 x L5 (4)	Black	3.0 kgf-cm	86.00F87.735

15. Disconnect the web camera cable from its connector on the LCD bezel.



16. Remove the LCD panel with brackets from the LCD bezel.





---

## Removing the LCD Brackets

1. See “Removing the SD Dummy Card” on page 44.
2. See “Removing the Battery Pack” on page 45.
3. See “Removing the Back Cover” on page 46.
4. See “Removing the Hard Disk Drive Module” on page 48.
5. See “Removing the Wireless LAN Card” on page 50.
6. See “Removing the DIMM Module” on page 51.
7. See “Removing the Heatsink Module” on page 52.
8. See “Removing the CPU” on page 54.
9. See “Removing the Optical Drive Module” on page 55.
10. See “Removing the Middle Cover” on page 58.
11. See “Removing the Keyboard” on page 60.
12. See “Removing the LCD Module” on page 61.
13. See “Removing the LCD Bezel” on page 78.
14. See “Removing the LCD panel with the Brackets” on page 79.
15. Remove the six screws (H) securing the left and right LCD brackets to remove the brackets.



Size (Quantity)	Color	Torque	Part No.
M2 x L3 (6)	Silver		86.9A552.3R0

## Removing the Web Camera

1. See “Removing the SD Dummy Card” on page 44.
2. See “Removing the Battery Pack” on page 45.
3. See “Removing the Back Cover” on page 46.
4. See “Removing the Hard Disk Drive Module” on page 48.
5. See “Removing the Wireless LAN Card” on page 50.
6. See “Removing the DIMM Module” on page 51.
7. See “Removing the Heatsink Module” on page 52.
8. See “Removing the CPU” on page 54.
9. See “Removing the Optical Drive Module” on page 55.
10. See “Removing the Middle Cover” on page 58.

11. See “Removing the Keyboard” on page 60.
12. See “Removing the LCD Module” on page 61.
13. See “Removing the LCD Bezel” on page 78.
14. See “Removing the LCD panel with the Brackets” on page 79.
15. Pry to remove the web camera module from the LCD bezel.

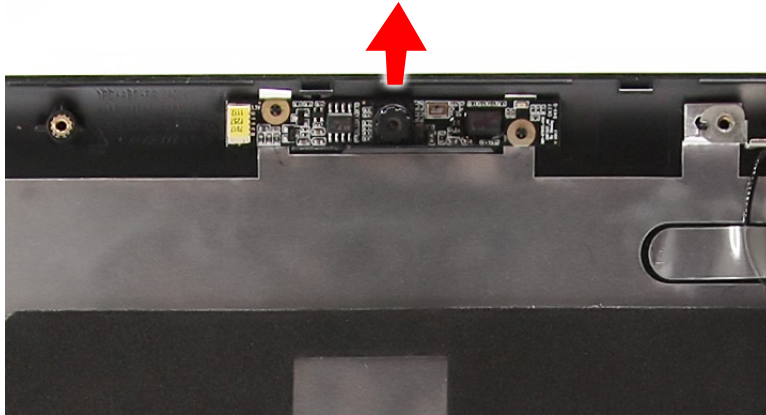

**WARNING:** The web camera module is glued to the LCD module back cover, only remove the web camera module if it is defective.

## Removing the FPC Cable

1. See “Removing the SD Dummy Card” on page 44.
2. See “Removing the Battery Pack” on page 45.
3. See “Removing the Back Cover” on page 46.
4. See “Removing the Hard Disk Drive Module” on page 48.
5. See “Removing the Wireless LAN Card” on page 50.
6. See “Removing the DIMM Module” on page 51.
7. See “Removing the Heatsink Module” on page 52.
8. See “Removing the CPU” on page 54.
9. See “Removing the Optical Drive Module” on page 55.
10. See “Removing the Middle Cover” on page 58.
11. See “Removing the Keyboard” on page 60.
12. See “Removing the LCD Module” on page 61.
13. See “Removing the LCD Bezel” on page 78.
14. See “Removing the LCD panel with the Brackets” on page 79.

---

**15.** Detach all adhesive tapes and any cable that is glued to the LCD panel.



**16.** Detach the FPC cable from its connector on the back of the LCD panel.

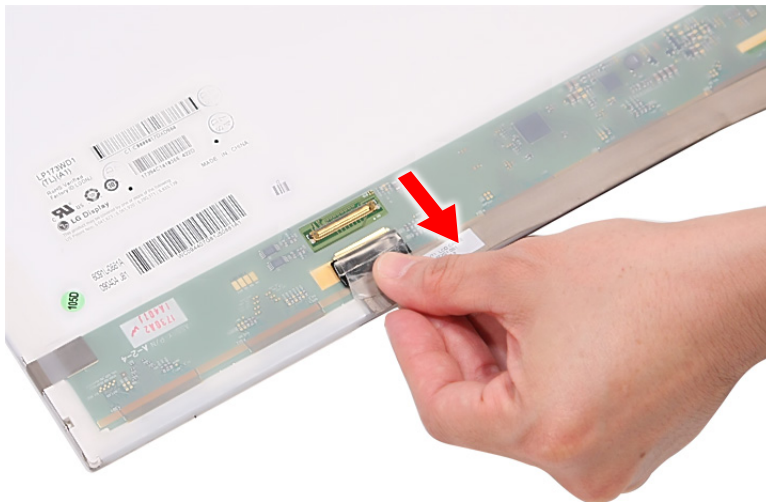

**17.** Disconnect the FPC cable from the LCD panel.

---

## Removing the Antennas

1. See “Removing the SD Dummy Card” on page 44.
2. See “Removing the Battery Pack” on page 45.
3. See “Removing the Back Cover” on page 46.
4. See “Removing the Hard Disk Drive Module” on page 48.
5. See “Removing the Wireless LAN Card” on page 50.
6. See “Removing the DIMM Module” on page 51.
7. See “Removing the Heatsink Module” on page 52.
8. See “Removing the CPU” on page 54.
9. See “Removing the Optical Drive Module” on page 55.
10. See “Removing the Middle Cover” on page 58.
11. See “Removing the Keyboard” on page 60.
12. See “Removing the LCD Module” on page 61.
13. See “Removing the LCD Bezel” on page 78.
14. See “Removing the LCD panel with the Brackets” on page 79.
15. See “Removing the Web Camera” on page 81.
16. See “Removing the FPC Cable” on page 82.
17. Release the antenna cables from the aluminium notches as shown.

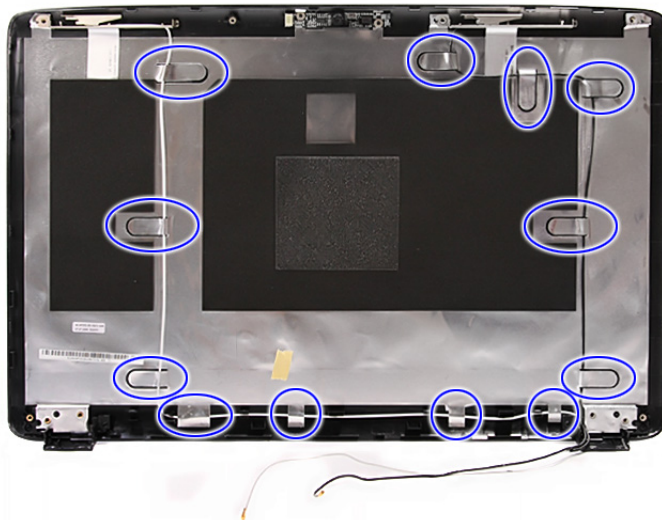

**NOTE:** There is no need to remove the antenna unless you really need to replace it.

# Troubleshooting

Use the following procedure as a guide for computer problems.

**NOTE:** The diagnostic tests are intended to test only Acer products. Non-Acer products, prototype cards, or modified options can give false errors and invalid system responses.

1. Obtain the failing symptoms in as much detail as possible.
2. Verify the symptoms by attempting to re-create the failure by running the diagnostic test or by repeating the same operation.
3. Use the following table with the verified symptom to determine which page to go to.

Symptoms (Verified)	Go To
Power failure. (The power indicator does not go on or stay on.)	"Power System Check" on page 87.
POST does not complete. No beep or error codes are indicated.	"Power-On Self-Test (POST) Error Message" on page 88 "Undetermined Problems" on page 102
POST detects an error and displayed messages on screen.	"Error Message List" on page 90
Other symptoms (i.e. LCD display problems or others).	"Power-On Self-Test (POST) Error Message" on page 88
Symptoms cannot be re-created (intermittent problems).	Use the customer-reported symptoms and go to "Power-On Self-Test (POST) Error Message" on page 88 "Intermittent Problems" on page 101 "Undetermined Problems" on page 102

---

# System Check Procedures

## External Diskette Drive Check

Do the following to isolate the problem to a controller, driver, or diskette. A write-enabled, diagnostic diskette is required.

**NOTE:** Make sure that the diskette does not have more than one label attached to it. Multiple labels can cause damage to the drive or cause the drive to fail.

Do the following to select the test device.

1. Boot from the diagnostics diskette and start the diagnostics program.
2. See if FDD Test is passed as the program runs to FDD Test.
3. Follow the instructions in the message window.

If an error occurs with the internal diskette drive, reconnect the diskette connector on the system board.

If the error still remains:

1. Reconnect the external diskette drive/DVD-ROM module.
2. Replace the external diskette drive/CD-ROM module.
3. Replace the main board.

## External Optical Disk Drive Check

Do the following to isolate the problem to a controller, drive, or optical disk drive. Make sure that the CD-ROM does not have any label attached to it. The label can cause damage to the drive or can cause the drive to fail.

Do the following to select the test device:

1. Boot from the diagnostics diskette and start the diagnostics program.
2. See if CD-ROM Test is passed when the program runs to CD-ROM Test.
3. Follow the instructions in the message window.

If an error occurs, reconnect the connector on the System board. If the error still remains:

1. Reconnect the external diskette drive/CD-ROM module.
2. Replace the external diskette drive/CD-ROM module.
3. Replace the main board.

## Keyboard or Auxiliary Input Device Check

Remove the external keyboard if the internal keyboard is to be tested.

If the internal keyboard does not work or an unexpected character appears, make sure that the flexible cable extending from the keyboard is correctly seated in the connector on the system board.

If the keyboard cable connection is correct, run the Keyboard Test.

If the tests detect a keyboard problem, do the following one at a time to correct the problem. Do not replace a non-defective FRU:

1. Reconnect the keyboard cables.
2. Replace the keyboard.
3. Replace the main board.

The following auxiliary input devices are supported by this computer:

- Numeric keypad
- External keyboard

---

If any of these devices do not work, reconnect the cable connector and repeat the failing operation.

## Memory Check

Memory errors might stop system operations, show error messages on the screen, or hang the system.

1. Boot from the diagnostics diskette and start the diagnostic program (please refer to main board).
2. Go to the diagnostic memory in the test items.
3. Press F2 in the test items.
4. Follow the instructions in the message window.

**NOTE:** Make sure that the DIMM is fully installed into the connector. A loose connection can cause an error.

## Power System Check

To verify the symptom of the problem, power on the computer using each of the following power sources:

1. Remove the battery pack.
2. Connect the power adapter and check that power is supplied.
3. Disconnect the power adapter and install the charged battery pack; then check that power is supplied by the battery pack.

If you suspect a power problem, see the appropriate power supply check in the following list:

- “Check the Power Adapter” on page 87
- “Check the Battery Pack” on page 88

## Check the Power Adapter

Unplug the power adapter cable from the computer and measure the output voltage at the plug of the power adapter cable. See the following figure

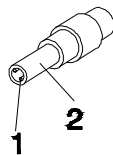

Pin 1: +19 to +20.5V

Pin 2: 0V, Ground

1. If the voltage is not correct, replace the power adapter.
2. If the voltage is within the range, do the following:
  - Replace the System board.
  - If the problem is not corrected, see “Undetermined Problems” on page 102.
  - If the voltage is not correct, go to the next step.

**NOTE:** An audible noise from the power adapter does not always indicate a defect.

3. If the power-on indicator does not light up, check the power cord of the power adapter for correct continuity and installation.
4. If the operational charge does not work, see “Check the Battery Pack” on page 88.

---

## Check the Battery Pack

To check the battery pack, do the following:

From Software:

1. Check out the Power Management in control Panel.
2. In Power Meter, confirm that if the parameters shown in the screen for Current Power Source and Total Battery Power Remaining are correct.
3. Repeat the steps 1 and 2, for both battery and adapter.
4. This helps you identify first the problem is on recharging or discharging.

From Hardware:

1. Power off the computer.
2. Remove the battery pack and measure the voltage between battery terminals 1(+) and 6(ground).
3. If the voltage is still less than 7.5 Vdc after recharging, replace the battery.

To check the battery charge operation, use a discharged battery pack or a battery pack that has less than 50% of the total power remaining when installed in the computer.

If the battery status indicator does not light up, remove the battery pack and let it return to room temperature. Re-install the battery pack.

If the charge indicator still does not light up, replace the battery pack. If the charge indicator still does not light up, replace the DC/DC charger board.

## Touchpad Check

If the touchpad doesn't work, do the following actions one at a time to correct the problem. Do not replace a non-defective FRU:

1. Reconnect the touchpad cables.
2. Replace the touchpad.
3. Replace the system board.

After you use the touchpad, the pointer drifts on the screen for a short time. This self-acting pointer movement can occur when a slight, steady pressure is applied to the touchpad pointer. This symptom is not a hardware problem. No service actions are necessary if the pointer movement stops in a short period of time.

## Power-On Self-Test (POST) Error Message

The POST error message index lists the error message and their possible causes. The most likely cause is listed first.

**NOTE:** Perform the FRU replacement or actions in the sequence shown in FRU/Action column, if the FRU replacement does not solve the problem, put the original part back in the computer. Do not replace a non-defective FRU.

This index can also help you determine the next possible FRU to be replaced when servicing a computer.

If the symptom is not listed, see "Undetermined Problems" on page 102.

The following lists the error messages that the BIOS displays on the screen and the error symptoms classified by function.

**NOTE:** Most of the error messages occur during POST. Some of them display information about a hardware device, e.g., the amount of memory installed. Others may indicate a problem with a device, such as the way it has been configured.

**NOTE:** If the system fails after you make changes in the BIOS Setup Utility menus, reset the computer, enter Setup and install Setup defaults or correct the error.



---

# Index of Error Messages

## Error Code List

Error Codes	Error Messages
006	Equipment Configuration Error Causes: 1. CPU BIOS Update Code Mismatch 2. IDE Primary Channel Master Drive Error (The causes will be shown before "Equipment Configuration Error")
010	Memory Error at xxx:xxx:xxxh (R:xxxh, W:xxxh)
070	Real Time Clock Error
071	CMOS Battery Bad
072	CMOS Checksum Error
110	System disabled. Incorrect password is specified.
<No error code>	Battery critical LOW In this situation BIOS will issue 4 short beeps then shut down system, no message will show.
<No error code>	Thermal critical High In this situation BIOS will shut down system, not show message.

## Error Message List

Error Messages	FRU/Action in Sequence
Failure Fixed Disk	Reconnect hard disk drive connector. "Load Default Settings" in BIOS Setup Utility. Hard disk drive System board
Stuck Key	see "Keyboard or Auxiliary Input Device Check" on page 86.
Keyboard error	see "Keyboard or Auxiliary Input Device Check" on page 86.
Keyboard Controller Failed	see "Keyboard or Auxiliary Input Device Check" on page 86.
Keyboard locked - Unlock key switch	Unlock external keyboard
Monitor type does not match CMOS - Run Setup	Run "Load Default Settings" in BIOS Setup Utility.
Shadow RAM Failed at offset: nnnn	BIOS ROM System board
System RAM Failed at offset: nnnn	DIMM System board
Extended RAM Failed at offset: nnnn	DIMM System board
System battery is dead - Replace and run Setup	Replace RTC battery and Run BIOS Setup Utility to reconfigure system time, then reboot system.
System CMOS checksum bad - Default configuration used	RTC battery Run BIOS Setup Utility to reconfigure system time, then reboot system.
System timer error	RTC battery Run BIOS Setup Utility to reconfigure system time, then reboot system. System board
Real time clock error	RTC battery Run BIOS Setup Utility to reconfigure system time, then reboot system. System board
Previous boot incomplete - Default configuration used	Run "Load Default Settings" in BIOS Setup Utility. RTC battery System board
Memory size found by POST differed from CMOS	Run "Load Default Settings" in BIOS Setup Utility. DIMM System board
Diskette drive A error	Check the drive is defined with the proper diskette type in BIOS Setup Utility See "External Diskette Drive Check" on page 86.
Incorrect Drive A type - run SETUP	Check the drive is defined with the proper diskette type in BIOS Setup Utility
System cache error - Cache disabled	System board
CPU ID:	System board
DMA Test Failed	DIMM System board
Software NMI Failed	DIMM System board

**Error Message List**

<b>Error Messages</b>	<b>FRU/Action in Sequence</b>
Fail-Safe Timer NMI Failed	DIMM System board
Device Address Conflict	Run "Load Default Settings" in BIOS Setup Utility. RTC battery System board
Allocation Error for device	Run "Load Default Settings" in BIOS Setup Utility. RTC battery System board
Failing Bits: nnnn	DIMM BIOS ROM System board
Fixed Disk n	None
Invalid System Configuration Data	BIOS ROM System board
I/O device IRQ conflict	Run "Load Default Settings" in BIOS Setup Utility. RTC battery System board
Operating system not found	Enter Setup and see if fixed disk and drive A: are properly identified. Diskette drive Hard disk drive System board

**Error Message List**

<b>No beep Error Messages</b>	<b>FRU/Action in Sequence</b>
No beep, power-on indicator turns off and LCD is blank.	Power source (battery pack and power adapter). See "Power System Check" on page 87.. Ensure every connector is connected tightly and correctly. Reconnect the DIMM. LED board. System board.
No beep, power-on indicator turns on and LCD is blank.	Power source (battery pack and power adapter). See "Power System Check" on page 87.. Reconnect the LCD connector Hard disk drive LCD inverter ID LCD cable LCD Inverter LCD System board
No beep, power-on indicator turns on and LCD is blank. But you can see POST on an external CRT.	Reconnect the LCD connectors. LCD inverter ID LCD cable LCD inverter LCD System board

---

### Error Message List

<b>No beep Error Messages</b>	<b>FRU/Action in Sequence</b>
No beep, power-on indicator turns on and a blinking cursor shown on LCD during POST.	Ensure every connector is connected tightly and correctly. System board
No beep during POST but system runs correctly.	Speaker System board

# Phoenix BIOS Beep Codes

Code	Beeps	POST Routine Description
02h		Verify Real Mode
03h		Disable Non-Maskable Interrupt (NMI)
04h		Get CPU type
06h		Initialize system hardware
08h		Initialize chipset with initial POST values
09h		Set IN POST flag
0Ah		Initialize CPU registers
0Bh		Enable CPU cache
0Ch		Initialize caches to initial POST values
0Eh		Initialize I/O component
0Fh		Initialize the local bus IDE
10h		Initialize Power Management
11h		Load alternate registers with initial POST values
12h		Restore CPU control word during warm boot
13h		Initialize PCI Bus Mastering devices
14h		Initialize keyboard controller
16h	1-2-2-3	BIOS ROM checksum
17h		Initialize cache before memory autosize
18h		8254 timer initialization
1Ah		8237 DMA controller initialization
1Ch		Reset Programmable Interrupt Controller
20h	1-3-1-1	Test DRAM refresh
22h	1-3-1-3	Test 8742 Keyboard Controller
24h		Set ES segment register to 4 GB
26h		Enable A20 line
28h		Autosize DRAM
29h		Initialize POST Memory Manager
2Ah		Clear 215 KB base RAM
2Ch	1-3-4-1	RAM failure on address line xxxx
2Eh	1-3-4-3	RAM failure on data bits xxxx of low byte of memory bus
2Fh		Enable cache before system BIOS shadow
30h	1-4-1-1	RAM failure on data bits xxxx of high byte of memory bus
32h		Test CPU bus-clock frequency
33h		Initialize Phoenix Dispatch Manager
36h		Warm start shut down
38h		Shadow system BIOS ROM
3Ah		Autosize cache

Code	Beeps	POST Routine Description
3Ch		Advanced configuration of chipset registers
3Dh		Load alternate registers with CMOS values
42h		Initialize interrupt vectors
45h		POST device initialization
46h	2-1-2-3	Check ROM copyright notice
48h		Check video configuration against CMOS
49h		Initialize PCI bus and devices
4Ah		Initialize all video adapters in system
4Bh		QuietBoot start (optional)
4Ch		Shadow video BIOS ROM
4Eh		Display BIOS copyright notice
50h		Display CPU type and speed
51h		Initialize EISA board
52h		Test keyboard
54h		Set key click if enabled
58h	2-2-3-1	Test for unexpected interrupts
59h		Initialize POST display service
5Ah		Display prompt "Press F2 to enter SETUP"
5Bh		Disable CPU cache
5Ch		Test RAM between 512 and 640 KB
60h		Test extended memory
62h		Test extended memory address lines
64h		Jump to User Patch1
66h		Configure advanced cache registers
67h		Initialize Multi Processor APIC
68h		Enable external and CPU caches
69h		Setup System Management Mode (SMM) area
6Ah		Display external L2 cache size
6Bh		Load custom defaults (optional)
6Ch		Display shadow-area message
6Eh		Display possible high address for UMB recovery
70h		Display error messages
72h		Check for configuration errors
76h		Check for keyboard errors
7Ch		Set up hardware interrupt vectors
7Eh		Initialize coprocessor if present
80h		Disable onboard Super I/O ports and IRQs
81h		Late POST device initialization

Code	Beeps	POST Routine Description
82h		Detect and install external RS232 ports
83h		Configure non-MCD IDE controllers
84h		Detect and install external parallel ports
85h		Initialize PC-compatible PnP ISA devices
86h		Re-initialize onboard I/O ports
87h		Configure Motherboard Configurable Devices (optional)
88h		Initialize BIOS Area
89h		Enable Non-Maskable Interrupts (NMIs)
8Ah		Initialize Extended BIOS Data Area
8Bh		Test and initialize PS/2 mouse
8Ch		Initialize floppy controller
8Fh		Determine number of ATA drives (optional)
90h		Initialize hard-disk controllers
91h		Initialize local-bus hard-disk controllers
92h		Jump to UserPatch2
93h		Build MPTABLE for multi-processor boards
95h		Install CD ROM for boot
96h		Clear huge ES segment register
97h		Fixup Multi Processor table
98h	1-2	Search for option ROMs. One long, two short beeps on checksum failure.
99h		Check for SMART drive (optional)
9Ah		Shadow option ROMs
9Ch		Set up Power Management
9Dh		Initialize security engine (optional)
9Eh		Enable hardware interrupts
9Fh		Determine number of ATA and SCSI drives
A0h		Set time of day
A2h		Check key lock
A4h		Initialize Typematic rate
A8h		Erase F2 prompt
AAh		Scan for F2 key stroke
ACh		Enter SETUP
A Eh		Clear Boot flag
B0h		Check for errors
B2h		POST done- prepare to boot operating system
B4h	1	One short beep before boot
B5h		Terminate QuietBoot (optional)
B6h		Check password (optional)

Code	Beeps	POST Routine Description
B9h		Prepare Boot
BAh		Initialize DMI parameters
BBh		Initialize PnP Option ROMs
BCh		Clear parity checkers
BDh		Display MultiBoot menu
BEh		Clear screen (optional)
BFh		Check virus and backup reminders
C0h		Try to boot with INT 19
C1h		Initialize POST Error Manager (PEM)
C2h		Initialize error logging
C3h		Initialize error display function
C4h		Initialize system error handler
C5h		PnPnd dual CMOS (optional)
C6h		Initialize notebook docking (optional)
C7h		Initialize notebook docking late
C8h		Force check (optional)
C9h		Extended checksum (optional)
D2h		Unknown interrupt
E0h		Initialize the chipset
E1h		Initialize the bridge
E2h		Initialize the CPU
E3h		Initialize the system timer
E4h		Initialize system I/O
E5h		Check force recovery boot
E6h		Checksum BIOS ROM
E7h		Go to BIOS
E8h		Set Huge Segment
E9h		Initialize Multi Processor
EAh		Initialize OEM special code
EBh		Initialize PIC and DMA
ECh		Initialize Memory type
EDh		Initialize Memory size
EEh		Shadow Boot Block
EFh		System memory test
F0h		Initialize interrupt vectors
F1h		Initialize Run Time Clock
F2h		Initialize video
F3h		Initialize System Management Mode
F4h	1	Output one beep before boot
F5h		Boot to Mini DOS
F6h		Clear Huge Segment
F7h		Boot to Full DOS



# Index of Symptom-to-FRU Error Message

## LCD-Related Symptoms

Symptom / Error	Action in Sequence
LCD backlight doesn't work LCD is too dark LCD brightness cannot be adjusted LCD contrast cannot be adjusted	Enter BIOS Utility to execute "Load Setup Default Settings", then reboot system. Reconnect the LCD connectors. Keyboard (if contrast and brightness function key doesn't work). LCD inverter ID LCD cable LCD inverter LCD System board
Unreadable LCD screen Missing pels in characters Abnormal screen Wrong color displayed	Reconnect the LCD connector LCD inverter ID LCD cable LCD inverter LCD System board
LCD has extra horizontal or vertical lines displayed.	LCD inverter ID LCD inverter LCD cable LCD System board

## Indicator-Related Symptoms

Symptom / Error	Action in Sequence
Indicator incorrectly remains off or on, but system runs correctly	Reconnect the inverter board Inverter board System board

## Power-Related Symptoms

Symptom / Error	Action in Sequence
Power shuts down during operation	Power source (battery pack and power adapter). See "Power System Check" on page 87. Battery pack Power adapter Hard drive & battery connection board System board
The system doesn't power-on.	Power source (battery pack and power adapter). See "Power System Check" on page 87. Battery pack Power adapter Hard drive & battery connection board System board

### Power-Related Symptoms

Symptom / Error	Action in Sequence
The system doesn't power-off.	Power source (battery pack and power adapter). See "Power System Check" on page 87. Hold and press the power switch for more than 4 seconds. System board
Battery can't be charged	See "Check the Battery Pack" on page 88. Battery pack System board

### PCMCIA-Related Symptoms

Symptom / Error	Action in Sequence
System cannot detect the PC Card (PCMCIA)	PCMCIA slot assembly System board
PCMCIA slot pin is damaged.	PCMCIA slot assembly

### Memory-Related Symptoms

Symptom / Error	Action in Sequence
Memory count (size) appears different from actual size.	Enter BIOS Setup Utility to execute "Load Default Settings, then reboot system. DIMM System board

### Speaker-Related Symptoms

Symptom / Error	Action in Sequence
In Windows, multimedia programs, no sound comes from the computer.	Audio driver Speaker System board
Internal speakers make noise or emit no sound.	Speaker System board

### Power Management-Related Symptoms

Symptom / Error	Action in Sequence
The system will not enter hibernation	See "Save to Disk (S4)" on page 26. Keyboard (if control is from the keyboard) Hard disk drive System board
The system doesn't enter hibernation mode and four short beeps every minute.	Press Fn+0 and see if the computer enters hibernation mode. Touchpad Keyboard Hard disk connection board Hard disk drive System board
The system doesn't enter standby mode after closing the LCD	See "Save to Disk (S4)" on page 26. LCD cover switch System board

### Power Management-Related Symptoms

Symptom / Error	Action in Sequence
The system doesn't resume from hibernation mode.	See "Save to Disk (S4)" on page 26. Hard disk connection board Hard disk drive System board
The system doesn't resume from standby mode after opening the LCD.	See "Save to Disk (S4)" on page 26. LCD cover switch System board
Battery fuel gauge in Windows doesn't go higher than 90%.	Remove battery pack and let it cool for 2 hours. Refresh battery (continue use battery until power off, then charge battery). Battery pack System board
System hangs intermittently.	Reconnect hard disk/CD-ROM drives. Hard disk connection board System board

### Peripheral-Related Symptoms

Symptom / Error	Action in Sequence
System configuration does not match the installed devices.	Enter BIOS Setup Utility to execute "Load Default Settings", then reboot system. Reconnect hard disk/CD-ROM/diskette drives.
External display does not work correctly.	Press Fn+F5, LCD/CRT/Both display switching System board
USB does not work correctly	System board
Print problems.	Onboard Devices Configuration Run printer self-test. Printer driver Printer cable Printer System Board
Serial or parallel port device problems.	Device driver Device cable Device System board

### Keyboard/Touchpad-Related Symptoms

Symptom / Error	Action in Sequence
Keyboard (one or more keys) does not work.	Reconnect the keyboard cable. Keyboard System board
Touchpad does not work.	Reconnect touchpad cable. Touchpad board System board

---

### Modem-Related Symptoms

Symptom / Error	Action in Sequence
Internal modem does not work correctly.	Modem phone port modem combo board System board

**NOTE:** If you cannot find a symptom or an error in this list and the problem remains, see “Undetermined Problems” on page 102.

---

# Intermittent Problems

Intermittent system hang problems can be caused by a variety of reasons that have nothing to do with a hardware defect, such as: cosmic radiation, electrostatic discharge, or software errors. FRU replacement should be considered only when a recurring problem exists.

When analyzing an intermittent problem, do the following:

1. Run the advanced diagnostic test for the system board in loop mode at least 10 times.
2. If no error is detected, do not replace any FRU.
3. If any error is detected, replace the FRU. Rerun the test to verify that there are no more errors.

---

# Undetermined Problems

The diagnostic problems does not identify which adapter or device failed, which installed devices are incorrect, whether a short circuit is suspected, or whether the system is inoperative.

Follow these procedures to isolate the failing FRU (do not isolate non-defective FRU).

**NOTE:** Verify that all attached devices are supported by the computer.

**NOTE:** Verify that the power supply being used at the time of the failure is operating correctly. (See "Power System Check" on page 87.):

1. Power-off the computer.
2. Visually check them for damage. If any problems are found, replace the FRU.
3. Remove or disconnect all of the following devices:
  - Non-Acer devices
  - Printer, mouse, and other external devices
  - Battery pack
  - Hard disk drive
  - DIMM
  - CD-ROM/Diskette drive Module
  - PC Cards
4. Power-on the computer.
5. Determine if the problem has changed.
6. If the problem does not recur, reconnect the removed devices one at a time until you find the failing FRU.
7. If the problem remains, replace the following FRU one at a time. Do not replace a non-defective FRU:
  - System board
  - LCD assembly

# Connector Locations

## Main Board

Aspire 7736/7736Z/7336 and 7540 Top View

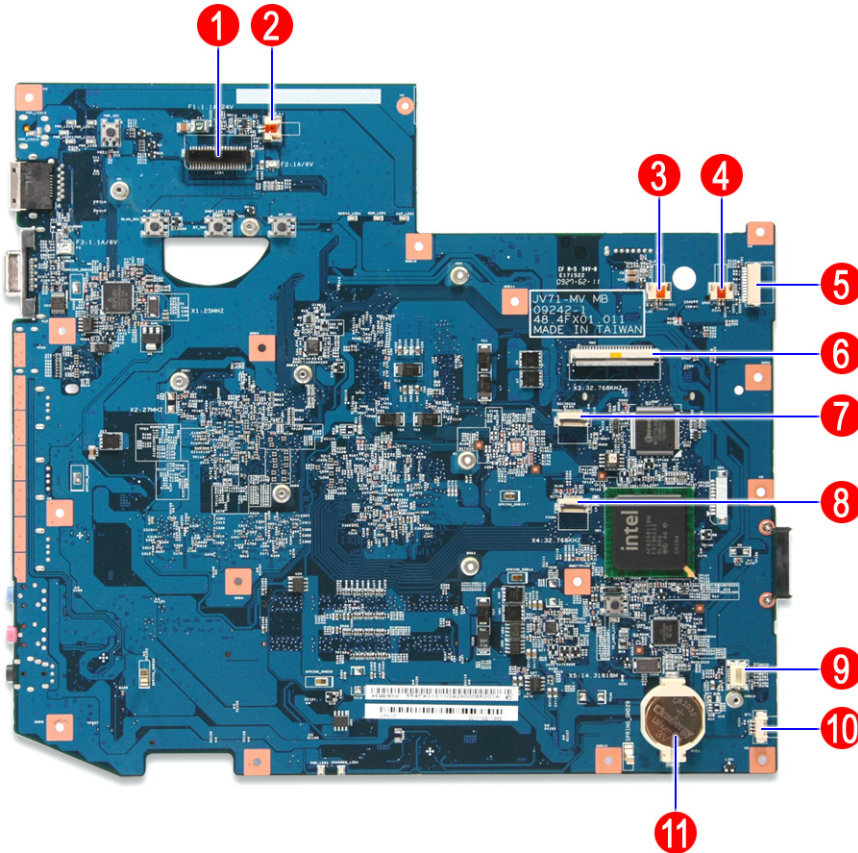

No.	Code	Connector
1	LCD1	LCD cable connector
2	SPKR_L1	Left speaker cable connector
3	MIC1	Microphone cable connector
4	SPKR_R1	Right speaker cable connector
5	USBCN1	USB cable connector
6	CN1	Keyboard cable connector
7	TP1CN1	Touchpad cable connector
8	FPCN1	Fingerprint or button connector
9	MDC1	Modem board connector
10	BT1	Bluetooth cable connector
11	RTC1	RTC battery socket

## Aspire 7736/7736Z/7336 and 7540 Bottom View

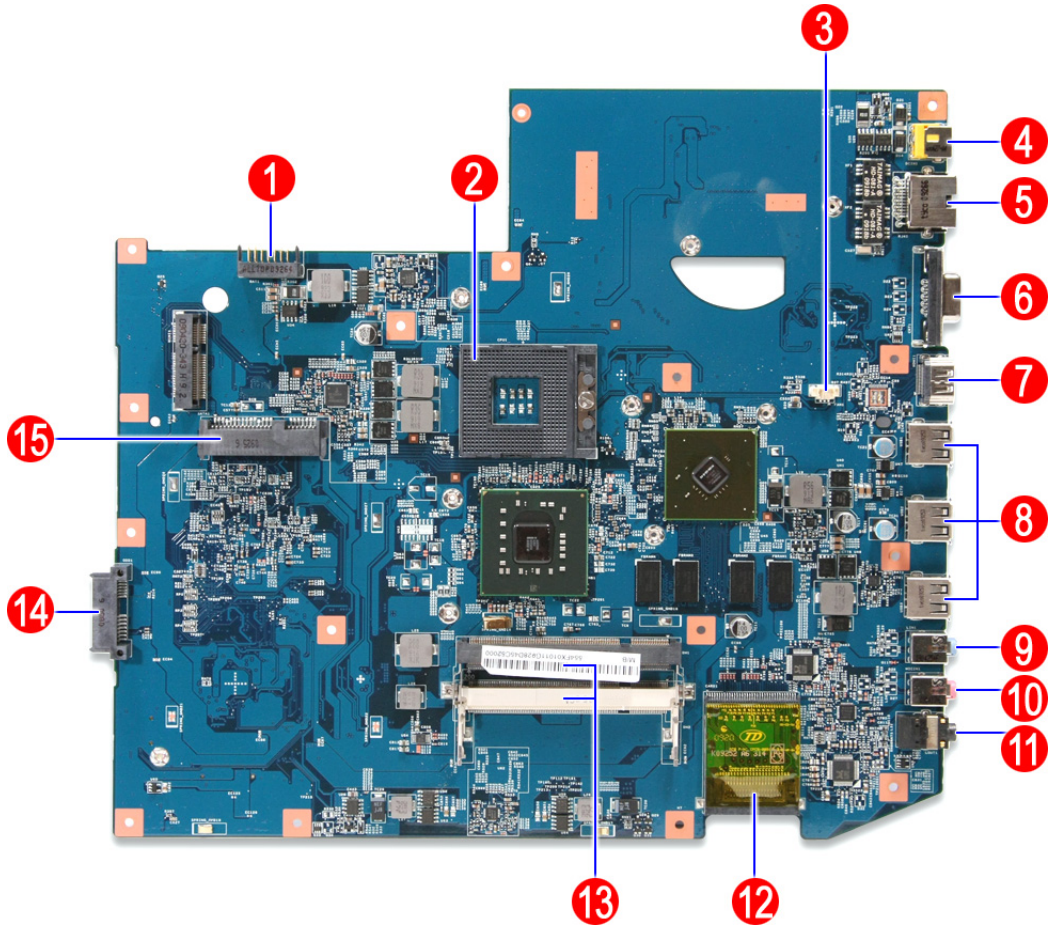

No.	Code	Connector
1	BAT1	Battery connector
2	CPU1	CPU socket
3	FAN1	Heatsink fan cable connector
4	DCIN1	DC-in connector
5	RJ45	Ethernet port
6	CRT1	External display (VGA) port
7	HDMI1	HDMI port
8	USB1~3	USB 2.0 Ports
9	LIN1	Line-in jack
10	MICIN1	Microphone in jack
11	LOUT1	Headphones/speaker/line-out jack with S/PDIF support
12	CARD1	SD card slot
13	DM1 and 2	DIMM slots 1 and 2
14	ODD1	Optical disk drive connector
15	SATA1	HDD connector



---

# Clearing Password Check and BIOS Recovery

This section provides the standard operating procedures for clearing the password and BIOS recovery for Aspire 7736/7736Z/7336 and Aspire 7540 Series. There is one Hardware Open Gap on the main board for clearing the password check and one Hotkey for enabling BIOS Recovery.

## Clearing Password Check

### Hardware Open Gap Description

Hardware	Default Setting	Operation Description
Gap	Open (Normal)	Short (Clearing Password Check)

HW Gap position on the main board:

Gap name in 7736/7736Z/7336 Series is **G78**.

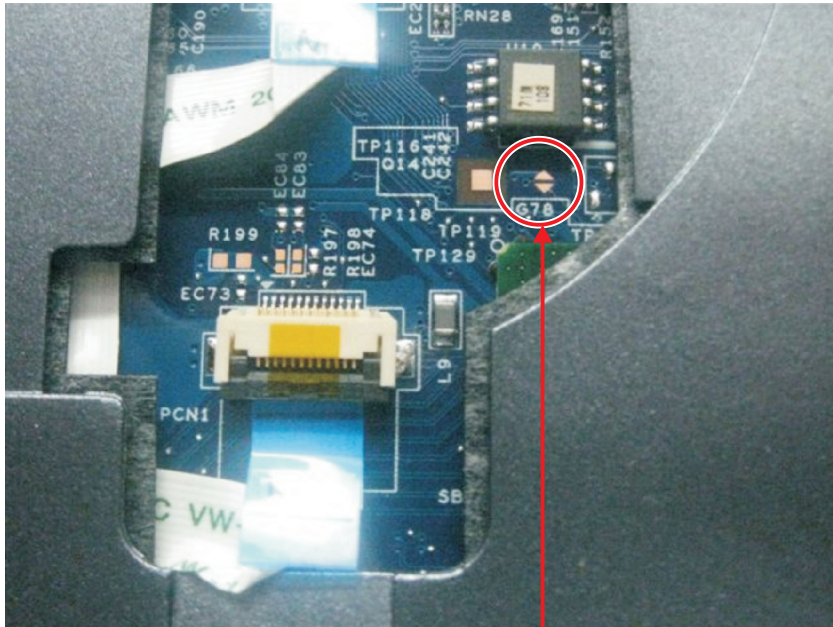

**G78**

Gap name in Aspire 7540 Series is **G106**.

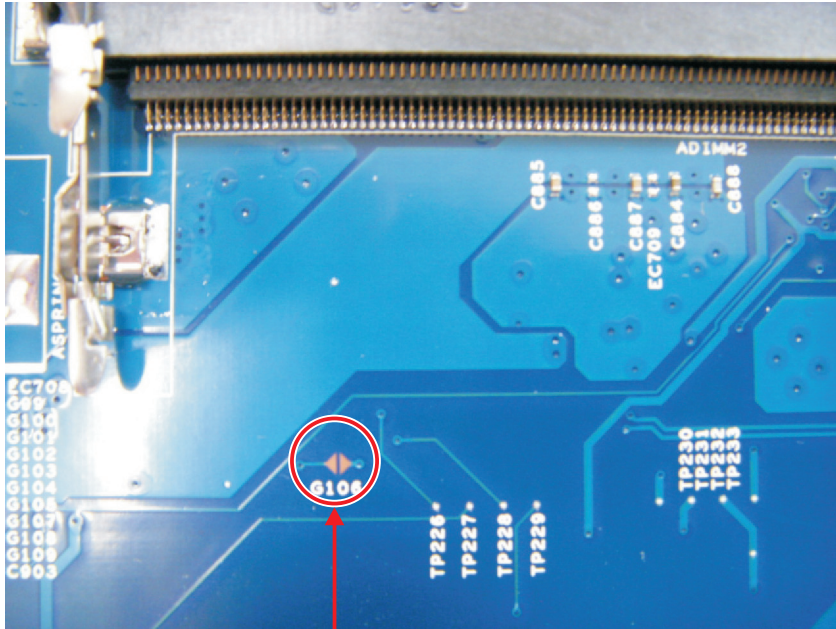

**G106**

## Steps for Clearing BIOS Password Check

If the user sets the BIOS Password (Supervisor Password and/or User Password) for a security reason, the BIOS will ask for the password during system POST or when the system enters into the BIOS Setup menu. If it is necessary to bypass the password check, the user needs to short the hardware gap to clear the password by following these steps:

- Power off the system, and remove the HDD, AC adapter and battery from the computer.
- Open the back cover of the computer and look for the hardware gap on the main board as shown in the picture(s) above.
- Use an electric conductivity tool to short the two points of the hardware gap.
- Plug in the AC adapter while retaining the short condition on the hardware gap. Press the power button to turn on the computer until the BIOS POST routine is finished. Finally, remove the tool from the hardware gap.
- Restart the system. Press the F2 key to enter BIOS Setup menu.
- If there is no password request, the BIOS Password is cleared. Otherwise, repeat the steps above and try again.

**NOTE:** The steps are only for clearing the BIOS password (Supervisor Password and User Password).

---

## BIOS Recovery by Crisis Disk

### BIOS Recovery Boot Block:

BIOS Recovery Boot Block is a special block of the BIOS. It is used to boot up the system with minimum BIOS initialization. Users can enable this feature to restore the BIOS firmware to a successful one once the previous BIOS flashing process failed.

### BIOS Recovery Hotkey

The system provides a function hotkey: **Fn+Esc**, for enabling the BIOS Recovery process at system power-on during BIOS POST. To use this function, the AC adapter and the battery must be connected. If this function is enabled, the system will force the BIOS to enter a special BIOS block called Boot Block.

## Steps for BIOS Recovery by Crisis Disk

Before doing this, prepare a Crisis Disk (refer to the “Steps for Creating the Crisis Disk in Windows XP/Vista” section below) and keep it ready in hand.

Follow these steps for BIOS recovery:

1. Power off the system.
2. Connect a removable USB storage device containing the Crisis Disk to a USB port connected to the BIOS flash failed system.
3. Under power-off state, press and hold **Fn+Esc** and then press the power button. The system should be powered on with the Crisis BIOS Recovery process.
4. BIOS Boot Block starts to restore the BIOS code from the Crisis Disk to BIOS ROM on the failed system.
5. After the crisis flashing process is finished, the system will restart.

After the Crisis Recovery process is finished, the system should have a successful and workable BIOS after power on. The user can then update the latest BIOS version for this system using the regular BIOS flashing process.

## Creating the Crisis Disk in Windows XP/Vista

Follow these steps to create the Crisis Disk:

1. Prepare a removable USB storage device (size greater than 10MB). Note that all data on the USB storage device will be cleared during the creation of the Crisis Disk.
2. Set up another computer loaded with Windows XP or Vista operating system.

- Decompress the Crisis Package Source. Select **WINCRIS.EXE** and then select **Run as administrator** under Vista.

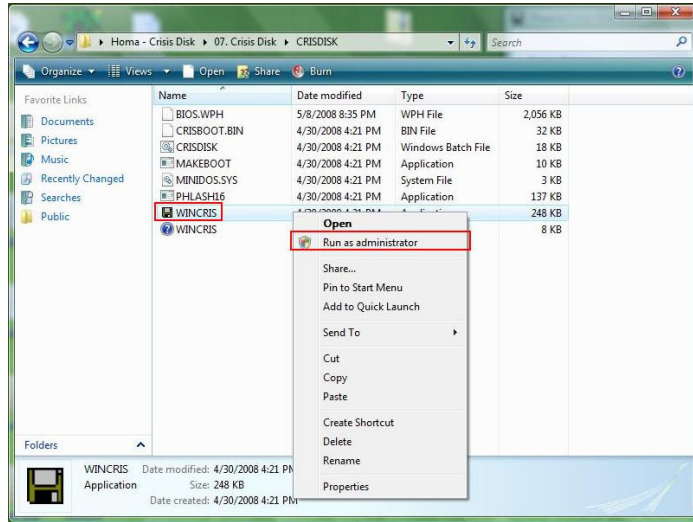

- Keep the default settings and then click on the **Start** button.

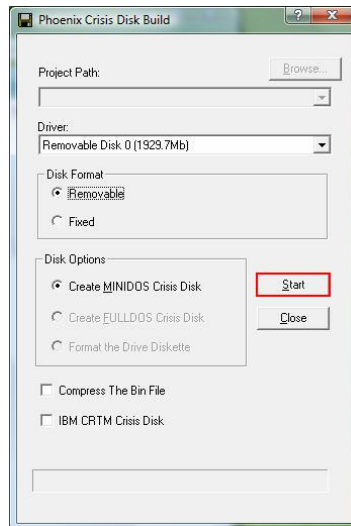

- When the pop-up warning dialog box appears, press **OK** to continue creating the Crisis Disk.

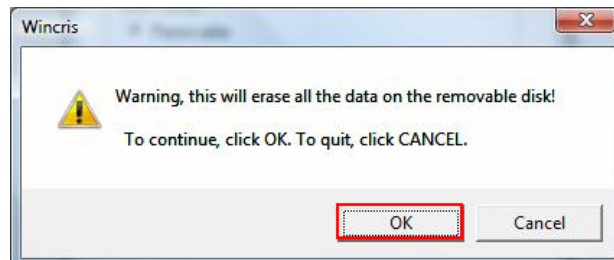

6. The Crisis Disk will be created after a few seconds.

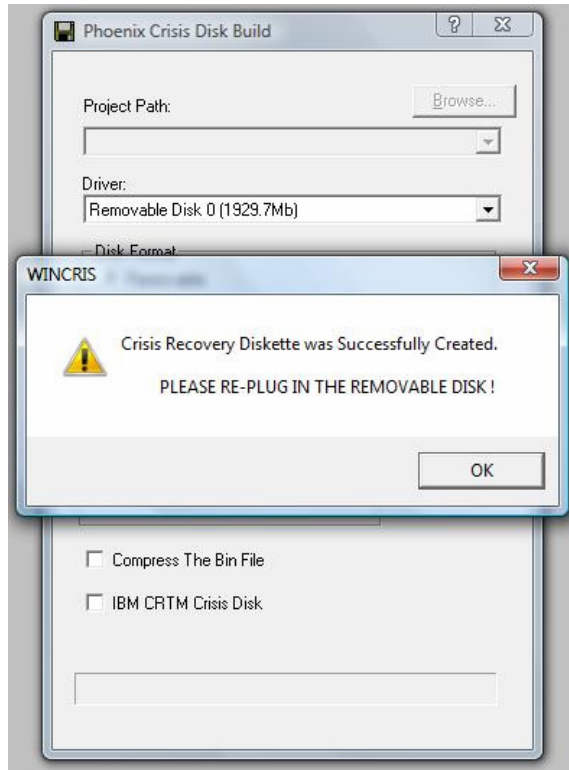

7. Press No if you do not want to create another Crisis Disk.

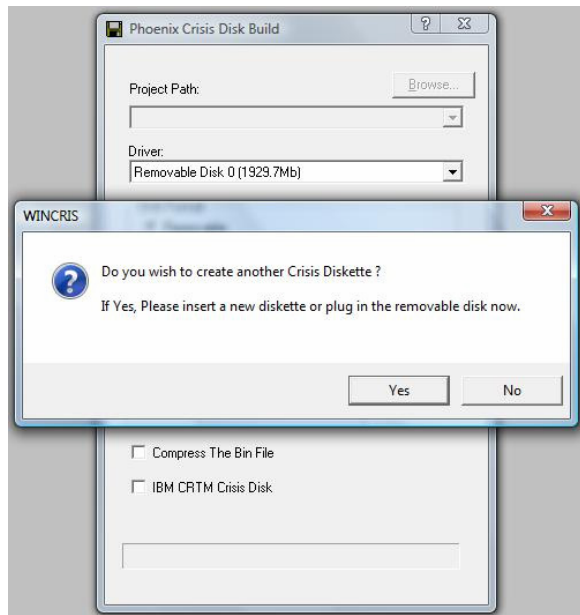

8. Reconnect the USB removable storage device and check if it contains the 3 files shown in the following figure.

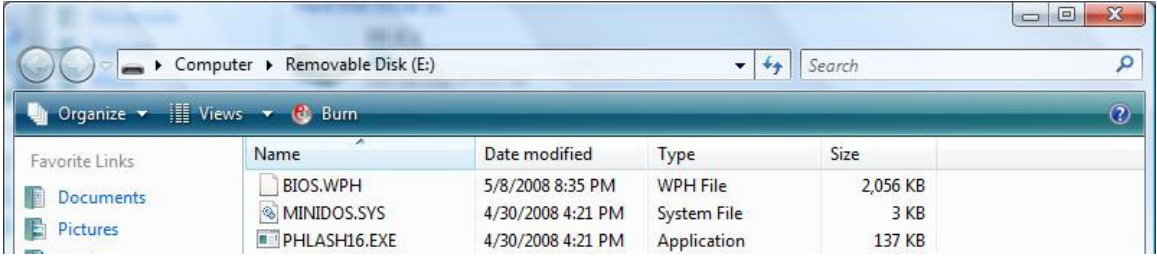

## FRU (Field Replaceable Unit) List

---

This chapter gives you the FRU (Field Replaceable Unit) listing in global configurations of Aspire 7736/7736Z/7336 and Aspire 7540 Series. Refer to this chapter whenever ordering for parts to repair or for RMA (Return Merchandise Authorization).

Please note that WHEN ORDERING FRU PARTS, you should check the most up-to-date information available on your regional web or channel. For whatever reasons a part number change is made, it will not be noted on the printed Service Guide. For ACER AUTHORIZED SERVICE PROVIDERS, your Acer office may have a DIFFERENT part number code from those given in the FRU list of this printed Service Guide. You MUST use the local FRU list provided by your regional Acer office to order FRU parts for repair and service of customer machines.

NOTE: To scrap or to return the defective parts, you should follow the local government ordinance or regulations on how to dispose it properly, or follow the rules set by your regional Acer office on how to return it.

# Aspire 7736/7736Z/7336 Series and Aspire 7540 Series Exploded Diagram

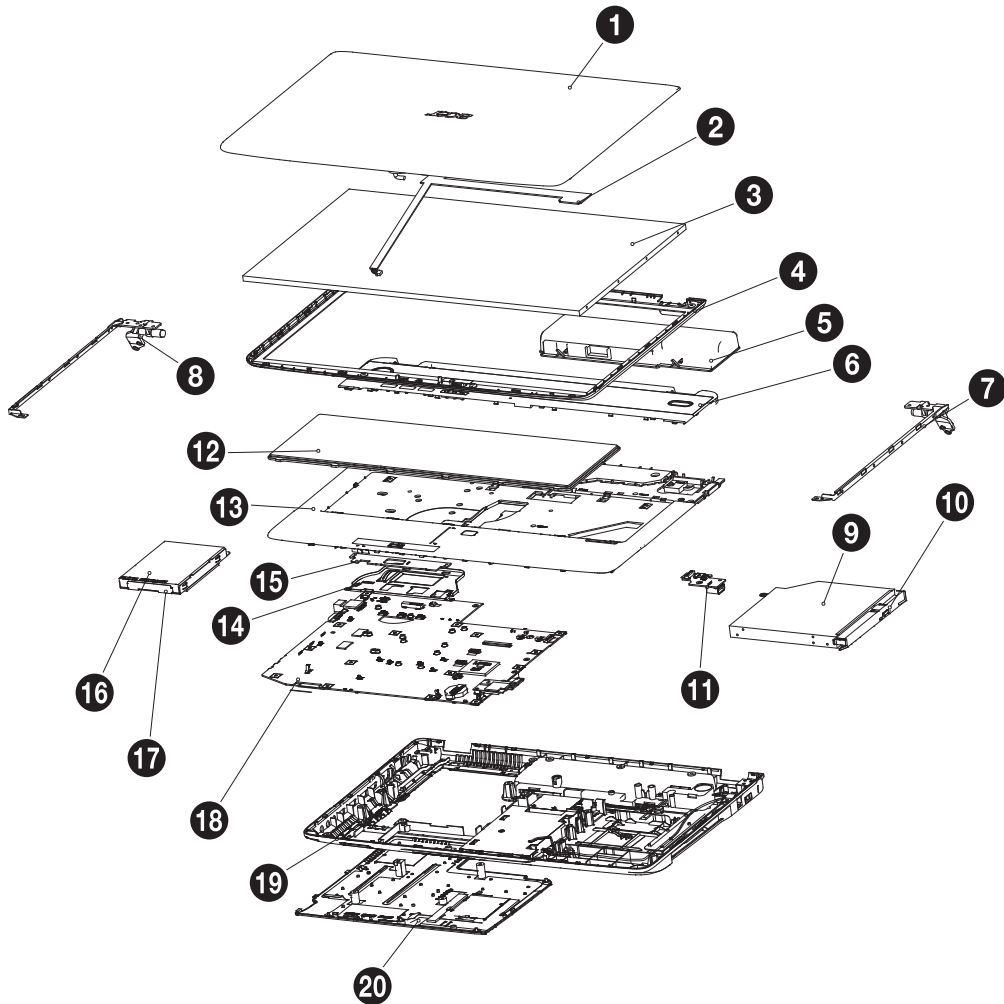

NO	P/N	DESCRIPTION
1	60.4FX02.001	ASSY 60 LCD panel JV71
2	50.4FX01.001	C.A. lcd JV71
3	LK.17308.001	LED LCD LPL 17.3" WXGA+ Glare
4	60.4FX01.001	ASSY 60 LCD bezel JV71
5	BT.00803.024	Battery SANYO AS-2007B
6	60.4FX08.001	ASSY 60 mid cover JV71
7	34.4FX02.001	Hinge left assy JV71
8	34.4FX01.001	Hinge Right assy JV71
9	KU.00801.035	ODD TOSHIBA Super-Multi
10	60.4FX14.001	ASSY 60 ODD bezel JV71
11	55.4FX02.001G	USB BOARD JV71
12	9J.N1H82.A1D	Keyboard ACER AC7T
13	60.4FX05.001	ASSY 60 Finger Ucase JV71
14	60.4FX04.001	ASSY 60 tp brkt JV7
15	TBD	Finger print board
16	TBD	HDD
17	60.4CG08.002	HDD BRKT ASSY
18	TBD	M/B JV71
19	60.4FX12.001	ASSY 60 LCASE JV71
20	60.4FX13.001	ASSY 60 Big door JV71



**Aspire 7736/7736Z/7336 Series FRU List**

1. ACER\_ASPIRE 7336 UMACBK\_JV71\_MV (NO: 91.4FX01.004G )

Category	No.	Part Name	Acer Part No.
<b>ADAPTER</b> 	1	ADP 65W 19V 3P ADP-65JH DB A,	AP.06501.026
	1	ADP 65W 19V 3P PA-1650-22AC LV	AP.06503.024
	1	ADP 65W 19V 3P HP-A0652R3B 1LF	AP.0650A.012
<b>BATTERY</b> 	1	BTY PACK LI+ 6C 2.2AH PANA	BT.00605.021
	1	BTY PACK LI+ 6C 2.2AH SANYO	BT.00603.042
	1	BTY PACK LI+ 6C 2.2AH SONY	BT.00604.025
	1	BTY PACK LI+ 6C 2.2AH SDI	BT.00606.001
	1	BTY PACK LI+ 8C 2.4AH SONY	BT.00804.020
	1	BTY PACK LI+ 8C 2.4AH SANYO	BT.00803.024
<b>BOARDS</b> 	1	BT MODULE FOXCONN BCM2046 V2.1	BH.21100.004
	1	JV71-MV FP BD W/O FP 09587-1(D)	TBD
	1	JV71-MV USB 09582-1 BD(D)	TBD
	2	MODEM MDC FOX_LSI AM5-V2H	FX.22500.023
	1	TOUCHPAD SYNAPTICS TM00540-005	56.ATR01.001
	1	TOUCHPAD ALPS KGDF0038A	56.PAW01.001
	1	WLAN 802.11BGN Atheros HB93 AR	NI.23600.054
	1	WLAN 802.11BGN Atheros HB93	NI.23600.046
	1	WLAN 802.11BG Atheros AR9285(H)	NI.23600.047
<b>CABLES</b> 	1	CORD USA/W CNS 2.5A 125V 8121-	27.01518.781
	1	POWER CORD TAIWANESE BLACK,1.8	27.01518.A11
	1	CORD SWISS 2.5A 250V 3P BK	27.01518.581
	1	CORD 10A 250V 3P SWISS BK	27.01518.691
	1	CORD ARGENTINE,10A 250V3G,1.8M	27.01518.0U1
	1	CORD US 7A 125V BK	27.T30V1.001
	1	CORD 10A 125V 3P US BK	27.01518.641
	1	CORD 7A250V 2P 1830 KOREAN	27.01518.531
	1	CORD UK 2.5A 250V 3P BK	27.01518.541
	1	CORD 5A 250V 3P UK BK	27.03118.001

Category	No.	Part Name	Acer Part No.
<b>CABLES</b>	1	CORD JAPAN 7A 125V 2P BK	27.01518.551
	1	CORD DENMARK 2.5A 250V 3P BK	27.01518.561
	1	CORD 10A 250V 3P DENMARK BK	27.01518.671
	1	CORD SOUTH AFRICA 16A 250V BK	27.01518.571
	1	CORD 16A 250V SOUTH AFRICA BK	27.01518.681
	1	CORD CHINA 10A 250V 3P	27.01518.591
	1	CORD 10A 250V 3P CHINA BK	27.01518.701
	1	CORD EUR 250V 3P BK	27.T30V1.004
	1	CORD 16A 250V 3P EUR BK	27.01518.731
	1	CORD ITALY 10A 250V 3P BK	27.01518.611
	1	CORD 10A 250V 3P ITALY BK	27.01518.711
	1	CORD 2.5A 250V AUSTRALIA BK	27.01518.621
	1	CORD 2.5A 250V SOUTH AFRICA BK	27.01518.631
	1	CORD 6A 250V SOUTH AFRICA BK	27.01518.721
	1	CORD 7A 125V 2P JAPAN BK	27.01518.661
	1	CORD 250V 10~16A 3P ISRAEL	27.01518.761
	1	POWER CORD BRAZIL, BLK, 1.8M	27.01518.A41
	1	POWER CORD ACA / ACNZ ANNIE	27.03218.021
	1	CORD 7.5A 250V 3P AUSTRALIA BK	27.03218.051
	1	CORD 7A 125V JAPAN 2PIN BK	27.03518.161
	1	JV71_TP_FFC	TBD
	1	TR_JV71_TP_FFC	TBD
	1	JV71_FP_FFC	TBD
	1	TR_JV71_FP_FFC	TBD
	2	CABLE RJ11 JV71	TBD
	1	CABLE USB JV71	TBD
	1	C.A. USB JV71(HT)	TBD
	1	C.A. BLUETOOTH JV71	TBD
	1	C.A. BLUETOOTH JV71(WANSH)	TBD
	1	C.A. BLUETOOTH JV71(HT)	TBD
	2	C.A. LCD JV71(MEC)	TBD
	2	C.A. LCD JV71(WANSH)	TBD
	<b>CAMERA</b>	2	CAMERA 0.3M CN0314-SN30-OV03-5
2		CAMERA 0.3M CNF701721004973L	57.W9401.001

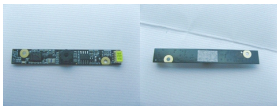

Category	No.	Part Name	Acer Part No.
<b>CASE/COVER/BRACKET ASSEMBLY</b> 	2	ASSY 60 LCD BEZEL JV71	TBD
	2	ASSY 60 LCD PANEL JV71(1+1)	TBD
	1	ASSY JV71 TP BRKT	TBD
	1	ASSY JV71 AMD MIDDLE COVER	TBD
	1	ASSY JV71_HDD_DOR	TBD
	1	ASSY 60 NO FINGER UCASE JV71	TBD
	1	ASSY 60_LCASE_JV71	TBD
	2	ASSY 60 HDD JV50	33.PAW01.003
	2	ASSY ODD BEZEL JV71	TBD
	2	BRKT ODD JV50	33.PAW01.002
	2	HINGE LEFT ASSYJV71(LH)	TBD
	2	HINGE LEFT ASSY JV71(SZS)	TBD
	2	HINGE RIGHT ASSYJV71(LH)	TBD
	2	HINGE RIGHTTT ASSY JV71(SZS)	TBD
	1	SD DUMMY CARD MYALL2	42.TKJ01.001
	2	JV71_ODD_BLUE RAY_ASSY	TBD
<b>COMBO MODULE</b> 	1	ODD NBDCB4XS BLU-RAY JV71_MV	
	2	BD COMBO SATA W7 PLDS DS-4E1S	KO.0040F.003
	2	BD COMBO SATA W7 SONY BC-5500S	KO.0040E.002
<b>CPU/PROCESSOR</b>	1	IC CPU CELERON 900 2.2G PGA	KC.N0001.900
	1	IC CPU CELERON T3100 1.9G PGA	KC.31001.CMT
<b>DVD-RW DRIVE</b> 	1	ODD NSM8XS SUPER-MULTI JV71_MV	
	2	ODD SM12.7 HFW7 TSST TS-L633C	KU.00801.035
	2	ODD SM12.7 HF+W7 HLDS GT30N	KU.0080D.048
<b>HDD/HARD DISK DRIVE</b> 	1	HDD N160GB5.4KS FOR JV71_MV	
	2	HDD 160GB HGST HTS545016B9A300	KH.16007.024
	2	HDD 160GB WD WD1600BEVT-22ZCT0	KH.16008.022
	1	HDD N250GB5.4KS FOR JV71_MV	
	2	HDD 250GB HGST HTS545025B9A300	KH.25007.015
	1	HDD N320GB5.4KS FOR JV71_MV	
	2	HDD 320GB HGST HTS545032B9A300	KH.32007.007
	2	HDD 320GB WD WD3200BEVT-22ZCT0	KH.32008.013
	1	HDD N500GB5.4KS FOR JV71_MV	
	2	HDD 500GB WD5000BEVT-22ZAT0	KH.50008.013
<b>HEATSINK</b> 	1	ASSY THERMAL JV71 MV UMA FCVF	TBD
	1	ASSY THERMAL JV71 MV UMA FOXS	TBD

Category	No.	Part Name	Acer Part No.
<b>KEYBOARD</b> 	1	KB MP-09B26GB-442 UK 104 AC7T	KB.I170A.055
	1	KB NSK-ALA0U UK 104KEY AC7T	KB.I170A.055
	1	KB NSK-ALA1D US-IN 103KEY AC7T	KB.I170A.056
	1	KB MP-09B23U4-442 USI 103 AC7T	KB.I170A.056
	1	KB NSK-ALA0A ARABI 103KEY AC7T	KB.I170A.032
	1	KB MP-09B23A0-442 ARA 103 AC7T	KB.I170A.032
	1	KB NSK-ALA1A BELGI 104KEY AC7T	KB.I170A.033
	1	KB MP-09B26B0-442 BEL 104 AC7T	KB.I170A.033
	1	KB NSK-ALA1B BRZ 104KEY AC7T	KB.I170A.034
	1	KB MP-09B26PA-442 BRA 104 AC7T	KB.I170A.034
	1	KB NSK-ALA13 CZ/SK 104KEY AC7T	KB.I170A.035
	1	KB MP-09B26CS-442 CZK 104 AC7T	KB.I170A.035
	1	KB NSK-ALA02 TAIWA 103KEY AC7T	KB.I170A.036
	1	KB MP-09B23RC-442 CHI 103 AC7T	KB.I170A.036
	1	KB NSK-ALA0D DANIS 104KEY AC7T	KB.I170A.037
	1	KB MP-09B26DK-442 DAN 104 AC7T	KB.I170A.037
	1	KB NSK-ALA2A FRA 104KEY AC7T	KB.I170A.038
	1	KB MP-09B26AF-442 FRA 104 AC7T	KB.I170A.038
	1	KB NSK-ALA0F FRENC 104KEY AC7T	KB.I170A.039
	1	KB MP-09B26F0-442 FRE 104 AC7T	KB.I170A.039
	1	KB NSK-ALA0G GERMA 104KEY AC7T	KB.I170A.040
	1	KB MP-09B26D0-442 GER 104 AC7T	KB.I170A.040
	1	KB NSK-ALA0L GREEK 103KEY AC7T	KB.I170A.041
	1	KB MP-09B23GR-442 GRE 103 AC7T	KB.I170A.041
	1	KB NSK-ALA0Q HUNGA 104KEY AC7T	KB.I170A.042
	1	KB MP-09B26HU-442 HUN 104 AC7T	KB.I170A.042
	1	KB NSK-ALA0E ITALI 104KEY AC7T	KB.I170A.043
	1	KB MP-09B26I0-442 ITA 104 AC7T	KB.I170A.043
	1	KB NSK-ALA0J JAPAN 107KEY AC7T	KB.I170A.044
	1	KB MP-09B20J0-442 JAP 107 AC7T	KB.I170A.044
	1	KB NSK-ALA1K NORDI 104KEY AC7T	KB.I170A.045
	1	KB MP-09B26DN-442 NOD 104 AC7T	KB.I170A.045
	1	KB NSK-ALA0N NORWE 104KEY AC7T	KB.I170A.046
1	KB MP-09B26N0-442 NOR 104 AC7T	KB.I170A.046	
1	KB NSK-ALA06 PORTU 104KEY AC7T	KB.I170A.047	
1	KB MP-09B26P0-442 POR 104 AC7T	KB.I170A.047	
1	KB NSK-ALA0R RUSSI 103KEY AC7T	KB.I170A.048	
1	KB MP-09B23SU-442 RUS 103 AC7T	KB.I170A.048	

Category	No.	Part Name	Acer Part No.
<b>KEYBOARD</b>	1	KB NSK-ALA1F SLOVE 104KEY AC7T	KB.I170A.049
	1	KB MP-09B26SA-442 SLO 104 AC7T	KB.I170A.049
	1	KB NSK-ALA0S SPANI 104KEY AC7T	KB.I170A.050
	1	KB MP-09B26E0-442 SPA 104 AC7T	KB.I170A.050
	1	KB NSK-ALA0W SWEDI 104KEY AC7T	KB.I170A.051
	1	KB MP-09B26S0-442 SWE 104 AC7T	KB.I170A.051
	1	KB NSK-ALA00 SWISS 104KEY AC7T	KB.I170A.052
	1	KB MP-09B26CH-442 SWI 104 AC7T	KB.I170A.052
	1	KB NSK-ALA03 THAIL 103KEY AC7T	KB.I170A.053
	1	KB MP-09B23T0-442 THA 103 AC7T	KB.I170A.053
	1	KB NSK-ALA0T TURKI 104KEY AC7T	KB.I170A.054
	1	KB MP-09B26TQ-442 TUR 104 AC7T	KB.I170A.054
	1	KB NSK-ALA0H HEBRE 103KEY AC7T	KB.I170A.057
	1	KB MP-09B23HB-442 HEB 103 AC7T	KB.I170A.057
	1	KB NSK-ALA2M FCE 104KEY AC7T	KB.I170A.058
	1	KB MP-09B26CU-442 FCE 104 AC7T	KB.I170A.058
<b>LCD</b>	1	LCD NLED17.3WXGA+G ANT*2 W/CAM	
	2	LCD 17.3"WXGA+ LP173WD1-TLA1 G	LK.17308.001
	2	LCD 17.3"WXGA+ AU B173RW01-V0	LK.17305.001
	2	LCD 17.3"WXGA+ CMO N173O6-L02	LK.1730D.001
<b>MAINBOARD</b> 	1	JV71-MV UMA MB 09242-1 GL40(D)	MB.PJB01.001
<b>MEMORY</b> 	1	SODIMM 1G HYMP112S64CP6-S6	KN.1GB0G.016
	1	SODIMM 1G M470T2864QZ3-CE6	KN.1GB0B.016
	1	SODIMM 1G HYMP112S64CP6-Y5	KN.1GB0G.012
	1	SODIMM 1G NT1GT64UH8D0FN-AD	KN.1GB03.025
	1	SODIMM 2G HMP125S6EFR8C-Y5	KN.2GB0G.012
	1	SODIMM 2G NT2GT64U8HD0BN-AD	KN.2GB03.010
	1	SODIMM 2G M470T5663EH3-CF7	KN.2GB0B.018
<b>MICROPHONE</b> 	2	MICROPHONE XINGMENG JV71	TBD
	2	MICROPHONE HIT JV71	TBD
<b>MISCELLANEOUS</b> 	1	JV71_7336_NAME_PLATE	TBD
	1	RUB CIRCLE BEZEL JV71	TBD
<b>SPEAKER</b>	2	SPEAKER FG JV71 L	TBD
	2	SPEAKER ZULUX JV71 L	TBD
	2	SPEAKER FG JV71 R	TBD
	2	SPEAKER ZYLUX JV71 R	TBD

Category	No.	Part Name	Acer Part No.
<b>SCREWS</b>	1	ISO M2.5X6(H=0.7~0.8MM)	86.00E12.536
	1	M2.5*L10 BLACK ZN	86.00F84.73A
	1	M2.5*L5 BLACK ZN+NYLOK	86.TK501.001
	1	SCRW M2.5XL4 D4.5 T0.8 GL	86.00H59.734
	1	SCREW M2-3	86.9A522.3R0
	1	SCRW M2*4 WAFER NI	86.9A552.4R0
	1	SCREW MACH WAFER M3*L4 NI	86.9A554.4R0
	1	SCRW M2.5L3.5	86.9A563.3R5

2. ACER\_ASPIRE 7736G N10MGS512CFBK V3\_JV71\_MV (NO: 91.4FX01.001G )

Category	No.	Part Name	Acer Part No.
<b>ADAPTER</b> 	1	ADAPTER 65W 19V 3PIN DELTA ADP-65JH DB A LV5 LED LF YELLOW	AP.06501.026
	1	ADAPTER 65W 19V 3PIN LITEON PA-1650-22AC LV5 LED LF YELLOW	AP.06503.024
	1	ADAPTER 65W 19V 3PIN HIPRO HP-A0652R3B 1LF LV5 LED LF YELLOW	AP.0650A.012
<b>BATTERY</b> 	1	BATTERY SONY AS-2007B LI-ION 4S2P SONY 8 CELL 4800MAH MAIN COMMON	BT.00804.020
	1	BATTERY SANYO AS-2007B LI-ION 4S2P SANYO 8 CELL 4800MAH MAIN COMMON	BT.00803.024
	1	BATTERY SANYO AS-2007B LI-ION 3S2P SANYO 6 CELL 4400MAH MAIN COMMON NORMAL TYPE	BT.00603.042
	1	BATTERY SONY AS-2007B LI-ION 3S2P SONY 6 CELL 4400MAH MAIN COMMON NORMAL TYPE	BT.00604.025
	1	BATTERY PANASONIC AS-2007B LI-ION 3S2P PANASONIC 6 CELL 4400MAH MAIN COMMON PSS	BT.00605.021
	1	BATTERY SIMPLO AS-2007B LI-ION 3S2P SAMSUNG 6 CELL 4400MAH MAIN COMMON SDI 2.2F	BT.00606.001
<b>BOARDS</b> 	1	BLUETOOTH BOARD FOXCONN BRM 2046 BT.1 T60H928.33 F/W:861	BH.21100.004
	1	FINGER PRINT SENSOR BOARD	55.PCC01.005
	1	FINGER PRINT BASE BOARD	TBD
	2	MODEM BOARD FOXCONN DELPHI-AM5 V2H 1.5_3.3V AUS T60M951.36	FX.22500.023
	1	TOUCHPAD BOARD ALPS KGDF0038A	56.PAW01.001
	1	TOUCHPAD BOARD SYNAPTICS TM00540-005	56.ATR01.001

Category	No.	Part Name	Acer Part No.
	1	USB BOARD	TBD
	1	WIRELESS LAN BOARD 512AN_HMWG SHIRLEY PEAK 5100 MM#895373	KI.SPH01.003
	1	WIRELESS LAN BOARD 512AG_MMWG SHIRLEY PEAK 5100 MM#897004	KI.SPM01.005
	1	WIRELESS LAN BOARD 512AN_MMWG SHIRLEY PEAK 5100 MM#895361	KI.SPM01.003
	1	WIRELESS LAN BOARD 512AN_MMWG SHIRLEY PEAK 5100 MM#895361	KI.SPM01.003
<b>CABLES</b>	1	BLUETOOTH BOARD CABLE	TBD
	1	BLUETOOTH BOARD CABLE	TBD
	1	BLUETOOTH BOARD CABLE	TBD
	1	FINGER PRINT / TP BUTTON BAORD CABLE	TBD
	1	FINGER PRINT / TP BUTTON BAORD CABLE	TBD
	2	LED LCD/CAMERA CABLE	TBD
	2	LED LCD/CAMERA CABLE	TBD
	2	MODEM CABLE	TBD
	1	POWER CABLE 16A 250V 3PIN EUR BK	27.01518.731
	1	POWER CORD 2.5A 125V USA	27.01518.781
	1	POWER CORD 2.5A 125V 1.8M BLACK TAIWANESE	27.01518.A11
	1	POWER CORD 10A 250V SWISS	27.01518.581
	1	POWER CORD 10A 250V 3PIN SWISS BK	27.01518.691
	1	POWER CORD 10A 250V ARGENTINE	27.01518.0U1
	1	POWER CORD 10A 125V US	27.T30V1.001
	1	POWER CORD 10A 125V 3PIN US BK	27.01518.641
	1	POWER CORD 7A 250V 2PIN KOREAN	27.01518.531
	1	POWER CORD 3A 250V 3PIN UK	27.01518.541
	1	POWER CORD 5A 250V 3PIN UK BK	27.03118.001
	1	POWER CORD 7A 125V 2PIN JAPAN	27.01518.551
	1	POWER CORD 10A 3PIN BK DENMARK	27.01518.561
	1	POWER CORD 10A 250V 3PIN DENMARK BK	27.01518.671
	1	POWER CORD 10A 250V 3PIN BK SOUTH AFRICA	27.01518.571
	1	POWER CORD 16A 250V SOUTH AFRICA BK	27.01518.681
	1	POWER CORD 10A 250V 3PIN CHINA	27.01518.591
	1	POWER CORD 10A 250V 3PIN CHINA BK	27.01518.701
	1	POWER CORD 250V 3PIN EUR BK	27.T30V1.004
	1	POWER CORD 10A 250V 3PIN ITALY	27.01518.611
	1	POWER CORD 10A 250V 3PIN ITALY BK	27.01518.711
	1	POWER CORD 2.5A 250V AUSTRALIA	27.01518.621
	1	POWER CORD 2.5A 250V SOUTH AFRICA BK (INDIA)	27.01518.631
	1	POWER CORD 10A 250V SOUTH AFRICA BK (INDIA)	27.01518.721
	1	POWER CORD 7A 125V 2PIN JAPAN BK	27.01518.661
	1	POWER CORD 250V 10A 3PIN ISRAEL	27.01518.761
	1	POWER CORD 10A 250V 1.8M BRAZIL BLK	27.01518.A41
	1	POWER CORD ACA / ACNZ	27.03218.021
	1	POWER CORD 7.5A 250V 3P AUSTRALIA BK	27.03218.051

Category	No.	Part Name	Acer Part No.
<b>CABLES</b>	1	POWER CORD 7A 125V 2PIN JAPAN	27.03518.161
	1	TOUCHPAD BOARD CABLE	TBD
	1	TOUCHPAD BOARD CABLE	TBD
	1	USB BOARD CABLE	TBD
	1	USB BOARD CABLE	TBD
	1	USB BOARD CABLE	TBD
<b>CAMERA</b> 	2	CAMERA 0.3M CHICONY CNF701721004973L	57.W9401.001
	2	CAMERA 0.3M SUYIN CN0314-SN30-OV03-5	57.N4401.001
<b>CASE/COVER/BRACKET ASSEMBLY</b> 	2	BLUE-RAY COMBO BEZEL	TBD
	2	DVD-RW SUPER-MULTI BEZEL	TBD
	2	LED LCD BRACKET LEFT W/HINGE	TBD
	2	LED LCD BRACKET LEFT W/HINGE	TBD
	2	LED LCD BRACKET RIGHT W/HINGE	TBD
	2	LED LCD BRACKET RIGHT W/HINGE	TBD
	2	LED LCD BEZEL 17.3" W/CAMERA HOLE	TBD
	2	LED LCD COVER 17.3" IMR BLUE W/ANTENNA*2 & LOGO	TBD
	1	LOWER CASE W/MODEM CABLE & MICROPHONE & SPEAKER	TBD
	1	MIDDLE COVER	TBD
	2	OPTICAL BRACKET	33.PAW01.002
	1	SD DUMMY CARD	42.TKJ01.001
	1	TOUCHPAD BRACKET	TBD
	1	UNITLOAD COVER	TBD
1	UPPER CASE BLACK W/SPEAKER & FINGER PRINT HOLE	TBD	
<b>COMBO MODULE</b> 	1	BLU-RAY COMBO MODULE 4X SATA WINDOWS7	
	2	ODD SONY BD COMBO 12.7MM TRAY DL 4X BC-5500S LF W/O BEZEL FW 1.E1 SATA FOR WINDOWS7	KO.0040E.002
	2	ODD PLDS BD COMBO 12.7MM TRAY DL 4X DS-4E1S LF W/O BEZEL SATA FOR WINDOWS7	KO.0040F.003
<b>CPU/PROCESSOR</b> 	1	CPU INTEL CORE2DUAL P8800 PGA 2.66G 3M 1066 25W R-0	KC.88R01.DPP
	1	CPU INTEL CORE2DUAL P7350 PGA 2.0G 3M 1066 25W	KC.73501.DPP
	1	CPU INTEL CORE2DUAL P7550 PGA 2.26G 3M 1066 R-0	KC.75501.DPP
	1	CPU INTEL CORE2DUAL T6500 PGA 2.1G 2M 800 R-0	KC.65001.DTP
<b>DVD-RW DRIVE</b> 	1	DVD-RW SUPER-MULTI MODULE 8X SATA WINDOWS7	
	2	ODD TOSHIBA SUPER-MULTI DRIVE 12.7MM TRAY DL 8X TS-L633C LF W/O BEZEL SATA FOR HF+WINDOWS7	KU.00801.035
	2	ODD HLDS SUPER-MULTI DRIVE 12.7MM TRAY DL 8X GT30N LF W/O BEZEL SATA FOR HF+WINDOWS7	KU.0080D.048



Category	No.	Part Name	Acer Part No.
<b>HDD/HARD DISK DRIVE</b> 	1	HDD MODULE 160GB 5400RPM SATA	
	2	HDD 160GB 5400RPM SATA HGST PANTHER-B PANTHER-B HTS545016B9A300 F/W:C60F	KH.16007.024
	2	HDD 160GB 5400RPM 2.5" SATA WD WD1600BEVT-22ZCT0 FW:11.01A11	KH.16008.022
	1	HDD MODULE 250GB 5400RPM SATA	
	2	HDD 250GB 5400RPM SATA HGST HTS545025B9A300 PANTHER-B LF	KH.25007.015
	1	HDD MODULE 320GB 5400RPM SATA	
	2	HDD 320GB 5400RPM SATA HGST HTS545032B9A300 PANTHER B LF	KH.32007.007
	2	HDD 320GB 5400RPM SATA WD WD3200BEVT-22ZCT0 ML125 F/W:01.01A01	KH.32008.013
	1	HDD MODULE 500GB 5400RPM SATA	
	2	HDD 500GB 5400RPM WD SATA WD5000BEVT-22ZAT0 F/W:01.01A01	KH.50008.013
<b>HEATSINK</b> 	1	CPU HEATSINK DISCRETE W/FAN	TBD
	1	CPU HEATSINK DISCRETE W/FAN	TBD
<b>KEYBOARD</b> 	1	KEYBOARD 103KEYS NSK-ALA0J AC7T JV50 INTERNAL 17 STANDARD BLACK TEXTURE US-INTERNATIONAL	KB.1170A.056
	1	KEYBOARD 103KEYS NSK-ALA0J AC7T JV50 INTERNAL 17 STANDARD BLACK TEXTURE US-INTERNATIONAL	KB.1170A.056
	1	KEYBOARD 103KEYS NSK-ALA0J AC7T JV50 INTERNAL 17 STANDARD BLACK TEXTURE ARABIC	KB.1170A.032
	1	KEYBOARD 103KEYS NSK-ALA0J AC7T JV50 INTERNAL 17 STANDARD BLACK TEXTURE ARABIC	KB.1170A.032
	1	KEYBOARD 104KEYS NSK-ALA0J AC7T JV50 INTERNAL 17 STANDARD BLACK TEXTURE BELGIAN	KB.1170A.033
	1	KEYBOARD 104KEYS NSK-ALA0J AC7T JV50 INTERNAL 17 STANDARD BLACK TEXTURE BELGIAN	KB.1170A.033
	1	KEYBOARD 104KEYS NSK-ALA0J AC7T JV50 INTERNAL 17 STANDARD BLACK TEXTURE BRAZILIAN PORTUGUESE	KB.1170A.034
	1	KEYBOARD 104KEYS NSK-ALA0J AC7T JV50 INTERNAL 17 STANDARD BLACK TEXTURE BRAZILIAN PORTUGUESE	KB.1170A.034
	1	KEYBOARD 104KEYS NSK-ALA0J AC7T JV50 INTERNAL 17 STANDARD BLACK TEXTURE CZECH/SLOVAK	KB.1170A.035
	1	KEYBOARD 104KEYS NSK-ALA0J AC7T JV50 INTERNAL 17 STANDARD BLACK TEXTURE CZECH/SLOVAK	KB.1170A.035
	1	KEYBOARD 103KEYS NSK-ALA0J AC7T JV50 INTERNAL 17 STANDARD BLACK TEXTURE TAIWAN	KB.1170A.036

Category	No.	Part Name	Acer Part No.
KEYBOARD	1	KEYBOARD 103KEYS NSK-ALA0J AC7T JV50 INTERNAL 17 STANDARD BLACK TEXTURE TAIWAN	KB.I170A.036
	1	KEYBOARD 104KEYS NSK-ALA0J AC7T JV50 INTERNAL 17 STANDARD BLACK TEXTURE DANISH	KB.I170A.037
	1	KEYBOARD 104KEYS NSK-ALA0J AC7T JV50 INTERNAL 17 STANDARD BLACK TEXTURE DANISH	KB.I170A.037
	1	KEYBOARD 104KEYS NSK-ALA0J AC7T JV50 INTERNAL 17 STANDARD BLACK TEXTURE FRENCH ARABIC	KB.I170A.038
	1	KEYBOARD 104KEYS NSK-ALA0J AC7T JV50 INTERNAL 17 STANDARD BLACK TEXTURE FRENCH ARABIC	KB.I170A.038
	1	KEYBOARD 104KEYS NSK-ALA0J AC7T JV50 INTERNAL 17 STANDARD BLACK TEXTURE FRENCH	KB.I170A.039
	1	KEYBOARD 104KEYS NSK-ALA0J AC7T JV50 INTERNAL 17 STANDARD BLACK TEXTURE FRENCH	KB.I170A.039
	1	KEYBOARD 104KEYS NSK-ALA0J AC7T JV50 INTERNAL 17 STANDARD BLACK TEXTURE GERMAN	KB.I170A.040
	1	KEYBOARD 104KEYS NSK-ALA0J AC7T JV50 INTERNAL 17 STANDARD BLACK TEXTURE GERMAN	KB.I170A.040
	1	KEYBOARD 103KEYS NSK-ALA0J AC7T JV50 INTERNAL 17 STANDARD BLACK TEXTURE GREEK	KB.I170A.041
	1	KEYBOARD 103KEYS NSK-ALA0J AC7T JV50 INTERNAL 17 STANDARD BLACK TEXTURE GREEK	KB.I170A.041
	1	KEYBOARD 104KEYS NSK-ALA0J AC7T JV50 INTERNAL 17 STANDARD BLACK TEXTURE HUNGARIAN	KB.I170A.042
	1	KEYBOARD 104KEYS NSK-ALA0J AC7T JV50 INTERNAL 17 STANDARD BLACK TEXTURE HUNGARIAN	KB.I170A.042
	1	KEYBOARD 104KEYS NSK-ALA0J AC7T JV50 INTERNAL 17 STANDARD BLACK TEXTURE ITALIAN	KB.I170A.043
	1	KEYBOARD 104KEYS NSK-ALA0J AC7T JV50 INTERNAL 17 STANDARD BLACK TEXTURE ITALIAN	KB.I170A.043
	1	KEYBOARD 107KEYS NSK-ALA0J AC7T JV50 INTERNAL 17 STANDARD BLACK TEXTURE JAPANESE	KB.I170A.044
	1	KEYBOARD 107KEYS NSK-ALA0J AC7T JV50 INTERNAL 17 STANDARD BLACK TEXTURE JAPANESE	KB.I170A.044
	1	KEYBOARD 104KEYS NSK-ALA0J AC7T JV50 INTERNAL 17 STANDARD BLACK TEXTURE NORDIC	KB.I170A.045
	1	KEYBOARD 104KEYS NSK-ALA0J AC7T JV50 INTERNAL 17 STANDARD BLACK TEXTURE NORDIC	KB.I170A.045
	1	KEYBOARD 104KEYS NSK-ALA0J AC7T JV50 INTERNAL 17 STANDARD BLACK TEXTURE NORWEGIAN	KB.I170A.046
	1	KEYBOARD 104KEYS NSK-ALA0J AC7T JV50 INTERNAL 17 STANDARD BLACK TEXTURE NORWEGIAN	KB.I170A.046
	1	KEYBOARD 104KEYS NSK-ALA0J AC7T JV50 INTERNAL 17 STANDARD BLACK TEXTURE PORTUGAL	KB.I170A.047

Category	No.	Part Name	Acer Part No.
KEYBOARD	1	KEYBOARD 104KEYS NSK-ALA0J AC7T JV50 INTERNAL 17 STANDARD BLACK TEXTURE PORTUGAL	KB.I170A.047
	1	KEYBOARD 103KEYS NSK-ALA0J AC7T JV50 INTERNAL 17 STANDARD BLACK TEXTURE RUSSIAN	KB.I170A.048
	1	KEYBOARD 103KEYS NSK-ALA0J AC7T JV50 INTERNAL 17 STANDARD BLACK TEXTURE RUSSIAN	KB.I170A.048
	1	KEYBOARD 104KEYS NSK-ALA0J AC7T JV50 INTERNAL 17 STANDARD BLACK TEXTURE SLOVE	KB.I170A.049
	1	KEYBOARD 104KEYS NSK-ALA0J AC7T JV50 INTERNAL 17 STANDARD BLACK TEXTURE SLOVE	KB.I170A.049
	1	KEYBOARD 104KEYS NSK-ALA0J AC7T JV50 INTERNAL 17 STANDARD BLACK TEXTURE SPANISH	KB.I170A.050
	1	KEYBOARD 104KEYS NSK-ALA0J AC7T JV50 INTERNAL 17 STANDARD BLACK TEXTURE SPANISH	KB.I170A.050
	1	KEYBOARD 104KEYS NSK-ALA0J AC7T JV50 INTERNAL 17 STANDARD BLACK TEXTURE SWEDISH	KB.I170A.051
	1	KEYBOARD 104KEYS NSK-ALA0J AC7T JV50 INTERNAL 17 STANDARD BLACK TEXTURE SWEDISH	KB.I170A.051
	1	KEYBOARD 104KEYS NSK-ALA0J AC7T JV50 INTERNAL 17 STANDARD BLACK TEXTURE SWISS	KB.I170A.052
	1	KEYBOARD 104KEYS NSK-ALA0J AC7T JV50 INTERNAL 17 STANDARD BLACK TEXTURE SWISS	KB.I170A.052
	1	KEYBOARD 103KEYS NSK-ALA0J AC7T JV50 INTERNAL 17 STANDARD BLACK TEXTURE THAILAND	KB.I170A.053
	1	KEYBOARD 103KEYS NSK-ALA0J AC7T JV50 INTERNAL 17 STANDARD BLACK TEXTURE THAILAND	KB.I170A.053
	1	KEYBOARD 104KEYS NSK-ALA0J AC7T JV50 INTERNAL 17 STANDARD BLACK TEXTURE TURKISH	KB.I170A.054
	1	KEYBOARD 104KEYS NSK-ALA0J AC7T JV50 INTERNAL 17 STANDARD BLACK TEXTURE TURKISH	KB.I170A.054
	1	KEYBOARD 104KEYS NSK-ALA0J AC7T JV50 INTERNAL 17 STANDARD BLACK TEXTURE UK	KB.I170A.055
	1	KEYBOARD 104KEYS NSK-ALA0J AC7T JV50 INTERNAL 17 STANDARD BLACK TEXTURE UK	KB.I170A.055
	1	KEYBOARD 103KEYS NSK-ALA0J AC7T JV50 INTERNAL 17 STANDARD BLACK TEXTURE HEBREW	KB.I170A.057
	1	KEYBOARD 103KEYS NSK-ALA0J AC7T JV50 INTERNAL 17 STANDARD BLACK TEXTURE HEBREW	KB.I170A.057
	1	KEYBOARD 104KEYS NSK-ALA0J AC7T JV50 INTERNAL 17 STANDARD BLACK TEXTURE FRENCH CANADIAN	KB.I170A.058
	1	KEYBOARD 104KEYS NSK-ALA0J AC7T JV50 INTERNAL 17 STANDARD BLACK TEXTURE FRENCH CANADIAN	KB.I170A.058

Category	No.	Part Name	Acer Part No.
<b>LCD</b>	1	LED LCD MODULE 17.3" WXGA GLARE IMR BLUE W/ ANTENNA*2&CAMERA 0.3M	
	2	LED LCD LPL 17.3" WXGA+ GLARE LP173WD1-TLA1 LF 220NIT 8MS 600:1	LK.17308.001
	2	LED LCD AUO 17.3" WXGA+ GLARE B173RW01-V0 LF 220NIT 8MS 600:1	LK.17305.001
	2	LED LCD CMO 17.3" WXGA+ GLARE N173O6-L02 LF 220NIT 8MS 600:1	LK.1730D.001
<b>MAINBOARD</b> 	1	MAINBOARD JV71_MV AS7736G DISCRETE INTEL PM45 ICH9M VRAM HYNIX GRAPHIC DDRIII 800 1GB H5TQ1G63BFR-12C LF W/RTC BATTERY&MODEM BOARD	MB.PHU01.001
<b>MEMORY</b> 	1	SODIMM 1GB DDRII667 SAMSUNG M470T2864QZ3-CE6 LF	KN.1GB0B.016
	1	SODIMM 1GB DDRII667 HYNIX HYMP112S64CP6-Y5 LF	KN.1GB0G.012
	1	SODIMM 1GB DDRII 800 NANYA NT1GT64UH8D0FN-AD LF 64*16 0.07UM	KN.1GB03.025
	1	SODIMM 1GB DDRII 800 HYNIX HYMP112S64CP6-S6 LF 64*16 0.065UM	KN.1GB0G.016
	1	SODIMM 2GB DDRII667 HYNIX HMP125S6EFR8C-Y5 LF	KN.2GB0G.012
	1	SODIMM 2GB DDRII 800 NANYA NT2GT64U8HD0BN-AD LF 128*8 0.07UM	KN.2GB03.010
	1	SODIMM 2GB DDRII 800 SAMSUNG M470T5663EH3-CF7 LF 128*8 0.055UM	KN.2GB0B.018
<b>MICROPHONE</b> 	2	MICROPHONE	TBD
	2	MICROPHONE	TBD
<b>MISCELLANEOUS</b>	1	NAME PLATE AS7736	TBD
	1	LCD SCREW RUBBER	TBD
<b>SCREWS</b>	1	SCREW M2.5X6 H=0.7~0.8MM	86.00E12.536
	1	SCREW M2.5*L10 BLACK ZN	86.00F84.73A
	1	SCREW M2.5*L5 BLACK ZN+NYLOK	86.TK501.001
	1	SCREW M2.5XL4 D4.5 T0.8 GL	86.00H59.734
	1	SCREW M2-3	86.9A522.3R0
	1	SCREW M2*4 WAFER NI	86.9A552.4R0
	1	SCREW MACH WAFER M3*L4 NI	86.9A554.4R0
	1	SCREW M2.5L3.5	86.9A563.3R5
<b>SPEAKER</b>	2	SPEAKER ON UPPER CASE	TBD
	2	SPEAKER ON UPPER CASE	TBD
	2	SPEAKER ON LOWER CASE	TBD
	2	SPEAKER ON LOWER CASE	TBD

3. ACER\_ASPIRE 7736ZG N10MGS512Cbk V3\_JV71\_MV (NO: S2.PJA02.002 )

Category	No.	Part Name	Acer Part No.
<b>ADAPTER</b> 	1	ADP 65W 19V 3P HP-A0652R3B 1LF	AP.0650A.012
	1	ADP 65W 19V 3P ADP-65JH DB A,	AP.06501.026
	1	ADP 65W 19V 3P PA-1650-22AC LV	AP.06503.024
<b>BATTERY</b> 	1	BTY PACK LI+ 6C 2.2AH SONY	BT.00604.025
	1	BTY PACK LI+ 6C 2.2AH SANYO	BT.00603.042
	1	BTY PACK LI+ 6C 2.2AH PANA	BT.00605.021
	1	BTY PACK LI+ 6C 2.2AH SDI	BT.00606.001
	1	BTY PACK LI+ 8C 2.4AH SONY	BT.00804.020
	1	BTY PACK LI+ 8C 2.4AH SANYO	BT.00803.024
<b>BOARDS</b> 	1	BT MODULE FOXCONN BCM2046 V2.1	BH.21100.004
		2	MODEM MDC FOX_LSI AM5-V2H
1		JV71-MV FP BD W/O FP 09587-1(D)	TBD
	1	JV71-MV USB 09582-1 BD(D)	TBD
		1	TOUCHPAD SYNAPTICS TM00540-005
1		TOUCHPAD ALPS KGDF0038A	56.PAW01.001
	1	WLAN 802.11BG Atheros AR9285(H)	NI.23600.047
	1	WLAN 802.11BGN Atheros HB93	NI.23600.046
	1	WLAN 802.11BGN Atheros HB93 AR	NI.23600.054

Category	No.	Part Name	Acer Part No.
<b>CABLES</b>	1	C.A. USB JV71(WANSH)	TBD
	1	C.A. USB JV71(HT)	TBD
	1	C.A. BLUETOOTH JV71	TBD
	1	C.A. BLUETOOTH JV71(WANSH)	TBD
	1	C.A. BLUETOOTH JV71(HT)	TBD
	2	C.A. LCD JV71(MEC)	TBD
	2	C.A. LCD JV71(WANSH)	TBD
	1	CABLE USB JV71	TBD
	1	CORD USA/W CNS 2.5A 125V 8121-	27.01518.781
	1	CODE SWISS 2.5A 250V 3P BK	27.01518.581
	1	CODE 10A 250V 3P SWISS BK	27.01518.691
	1	CORD ARGENTINE,10A 250V3G,1.8M	27.01518.0U1
	1	CODE US 7A 125V BK	27.T30V1.001
	1	CODE 10A 125V 3P US BK	27.01518.641
	1	CORD 7A250V 2P 1830 KOREAN	27.01518.531
	1	CODE UK 2.5A 250V 3P BK	27.01518.541
	1	CODE 5A 250V 3P UK BK	27.03118.001
	1	CODE JAPAN 7A 125V 2P BK	27.01518.551
	1	CODE DENMARK 2.5A 250V 3P BK	27.01518.561
	1	CODE 10A 250V 3P DENMARK BK	27.01518.671
	1	CODE SOUTH AFRICA 16A 250V BK	27.01518.571
	1	CODE 16A 250V SOUTH AFRICA BK	27.01518.681
	1	CORD CHINA 10A 250V 3P	27.01518.591
	1	CORD 10A 250V 3P CHINA BK	27.01518.701
	1	CORD EUR 250V 3P BK	27.T30V1.004
	1	CORD 16A 250V 3P EUR BK	27.01518.731
	1	CORD ITALY 10A 250V 3P BK	27.01518.611
	1	CORD 10A 250V 3P ITALY BK	27.01518.711
	1	CORD 2.5A 250V AUSTRALIA BK	27.01518.621
	1	CORD 2.5A 250V SOUTH AFRICA BK	27.01518.631
	1	CORD 6A 250V SOUTH AFRICA BK	27.01518.721
	1	CODE 7A 125V 2P JAPAN BK	27.01518.661
	1	CORD 250V 10~16A 3P ISRAEL	27.01518.761
	1	POWER CORD BRAZIL,BLK,1.8M	27.01518.A41
	1	POWER CODE ACA / ACNZ ANNIE	27.03218.021
	1	POWER CORD TAIWANESE BLACK,1.8	27.01518.A11
	1	CORD 7.5A 250V 3P AUSTRALIA BK	27.03218.051
	1	CORD 7A 125V JAPAN 2PIN BK	27.03518.161
	1	JV71_FP_FFC	TBD
	1	JV71_TP_FFC	TBD
	2	CABLE RJ11 JV71	TBD
	1	TR_JV71_FP_FFC	TBD
	1	TR_JV71_TP_FFC	TBD

Category	No.	Part Name	Acer Part No.
<b>CAMERA</b> 	2	CAMERA 0.3M CN0314-SN30-OV03-5	57.N4401.001
	2	CAMERA 0.3M CNF701721004973L	57.W9401.001
<b>CASE/COVER/BRACKET ASSEMBLY</b> 	2	ASSY 60 LCD BEZEL JV71	TBD
	2	ASSY 60 LCD PANEL JV71(1+1)	TBD
	1	ASSY 60 NO FINGER UCASE JV71	TBD
	1	ASSY 60_LCASE_JV71	TBD
	2	ASSY 60 HDD JV50	33.PAW01.003
	2	ASSY ODD BEZEL JV71	TBD
	1	ASSY JV71 AMD MIDDLE COVER	TBD
	1	ASSY JV71_HDD_DOR	TBD
	1	ASSY JV71 TP BRKT	TBD
	2	BRKT ODD JV50	33.PAW01.002
	2	HINGE LEFT ASSYJV71(LH)	TBD
	2	HINGE LEFT ASSY JV71(SZS)	TBD
	2	HINGE RIGHT ASSYJV71(LH)	TBD
	2	HINGE RIGHTT ASSY JV71(SZS)	TBD
	2	JV71_ODD_BLUE RAY_ASSY	TBD
<b>COMBO MODULE</b> 	1	ODD NBDCB4XS BLU-RAY JV71_MV	
	2	BD COMBO SATA W7 SONY BC-5500S	KO.0040E.002
	2	BD COMBO SATA W7 PLDS DS-4E1S	KO.0040F.003
<b>CPU/PROCESSOR</b> 	1	IC CPU PENRYN T4200 2.0G PGA	KC.42001.DTP
	1	IC CPU PENRYN T4300 2.1G PGA	KC.43001.DTP
<b>DVD-RW DRIVE</b> 	1	ODD NSM8XS SUPER-MULTI JV71_MV	
	2	ODD SM12.7 HF+W7 HLDS GT30N	KU.0080D.048
	2	ODD SM12.7 HFW7 TSST TS-L633C	KU.0080I.035
<b>HDD/HARD DISK DRIVE</b> 	1	HDD N160GB5.4KS FOR JV71_MV	
	2	HDD 160GB HGST HTS545016B9A300	KH.16007.024
	2	HDD 160GB WD WD1600BEVT-22ZCT0	KH.16008.022
	1	HDD N250GB5.4KS FOR JV71_MV	
	2	HDD 250GB HGST HTS545025B9A300	KH.25007.015
	1	HDD N320GB5.4KS FOR JV71_MV	
	2	HDD 320GB HGST HTS545032B9A300	KH.32007.007
	2	HDD 320GB WD WD3200BEVT-22ZCT0	KH.32008.013
	1	HDD N500GB5.4KS FOR JV71_MV	
2	HDD 500GB WD5000BEVT-22ZAT0	KH.50008.013	

Category	No.	Part Name	Acer Part No.
<b>HEATSINK</b> 	1	ASSY THERMAL JV71 MV DIS FCVF	TBD
	1	ASSY THERMAL JV71 MV DIS FOXS	TBD
<b>KEYBOARD</b> 	1	KB MP-09B23U4-442 USI 103 AC7T	KB.I170A.056
	1	KB NSK-ALA1D US-IN 103KEY AC7T	KB.I170A.056
	1	KB NSK-ALA0A ARABI 103KEY AC7T	KB.I170A.032
	1	KB MP-09B23A0-442 ARA 103 AC7T	KB.I170A.032
	1	KB NSK-ALA1A BELGI 104KEY AC7T	KB.I170A.033
	1	KB MP-09B26B0-442 BEL 104 AC7T	KB.I170A.033
	1	KB NSK-ALA1B BRZ 104KEY AC7T	KB.I170A.034
	1	KB MP-09B26PA-442 BRA 104 AC7T	KB.I170A.034
	1	KB NSK-ALA13 CZ/SK 104KEY AC7T	KB.I170A.035
	1	KB MP-09B26CS-442 CZK 104 AC7T	KB.I170A.035
	1	KB NSK-ALA02 TAIWA 103KEY AC7T	KB.I170A.036
	1	KB MP-09B23RC-442 CHI 103 AC7T	KB.I170A.036
	1	KB NSK-ALA0D DANIS 104KEY AC7T	KB.I170A.037
	1	KB MP-09B26DK-442 DAN 104 AC7T	KB.I170A.037
	1	KB NSK-ALA2A FRA 104KEY AC7T	KB.I170A.038
	1	KB MP-09B26AF-442 FRA 104 AC7T	KB.I170A.038
	1	KB NSK-ALA0F FRENC 104KEY AC7T	KB.I170A.039
	1	KB MP-09B26F0-442 FRE 104 AC7T	KB.I170A.039
	1	KB NSK-ALA0G GERMA 104KEY AC7T	KB.I170A.040
	1	KB MP-09B26D0-442 GER 104 AC7T	KB.I170A.040
	1	KB NSK-ALA0L GREEK 103KEY AC7T	KB.I170A.041
	1	KB MP-09B23GR-442 GRE 103 AC7T	KB.I170A.041
	1	KB NSK-ALA0Q HUNGA 104KEY AC7T	KB.I170A.042
	1	KB MP-09B26HU-442 HUN 104 AC7T	KB.I170A.042
	1	KB NSK-ALA0E ITALI 104KEY AC7T	KB.I170A.043
	1	KB MP-09B26I0-442 ITA 104 AC7T	KB.I170A.043
	1	KB NSK-ALA0J JAPAN 107KEY AC7T	KB.I170A.044
	1	KB MP-09B20J0-442 JAP 107 AC7T	KB.I170A.044
	1	KB NSK-ALA1K NORDI 104KEY AC7T	KB.I170A.045
	1	KB MP-09B26DN-442 NOD 104 AC7T	KB.I170A.045
	1	KB NSK-ALA0N NORWE 104KEY AC7T	KB.I170A.046
	1	KB MP-09B26N0-442 NOR 104 AC7T	KB.I170A.046
	1	KB NSK-ALA06 PORTU 104KEY AC7T	KB.I170A.047
1	KB MP-09B26P0-442 POR 104 AC7T	KB.I170A.047	
1	KB NSK-ALA0R RUSSI 103KEY AC7T	KB.I170A.048	
1	KB MP-09B23SU-442 RUS 103 AC7T	KB.I170A.048	
1	KB NSK-ALA1F SLOVE 104KEY AC7T	KB.I170A.049	
1	KB MP-09B26SA-442 SLO 104 AC7T	KB.I170A.049	
1	KB NSK-ALA0S SPANI 104KEY AC7T	KB.I170A.050	
1	KB MP-09B26E0-442 SPA 104 AC7T	KB.I170A.050	



Category	No.	Part Name	Acer Part No.
<b>KEYBOARD</b>	1	KB NSK-ALA0W SWEDI 104KEY AC7T	KB.I170A.051
	1	KB MP-09B26S0-442 SWE 104 AC7T	KB.I170A.051
	1	KB NSK-ALA00 SWISS 104KEY AC7T	KB.I170A.052
	1	KB MP-09B26CH-442 SWI 104 AC7T	KB.I170A.052
	1	KB NSK-ALA03 THAIL 103KEY AC7T	KB.I170A.053
	1	KB MP-09B23T0-442 THA 103 AC7T	KB.I170A.053
	1	KB NSK-ALA0T TURKI 104KEY AC7T	KB.I170A.054
	1	KB MP-09B26TQ-442 TUR 104 AC7T	KB.I170A.054
	1	KB NSK-ALA0U UK 104KEY AC7T	KB.I170A.055
	1	KB MP-09B26GB-442 UK 104 AC7T	KB.I170A.055
	1	KB NSK-ALA0H HEBRE 103KEY AC7T	KB.I170A.057
	1	KB MP-09B23HB-442 HEB 103 AC7T	KB.I170A.057
	1	KB NSK-ALA2M FCE 104KEY AC7T	KB.I170A.058
	1	KB MP-09B26CU-442 FCE 104 AC7T	KB.I170A.058
<b>LCD</b>	1	LCD NLED17.3WXGA+G ANT*2 W/CAM	
	2	LCD 17.3"WXGA+ CMO N173O6-L02	LK.1730D.001
	2	LCD 17.3"WXGA+ LP173WD1-TLA1 G	LK.17308.001
	2	LCD 17.3"WXGA+ AU B173RW01-V0	LK.17305.001
<b>MAINBOARD</b> 	1	JV71-MV DIS MB 09242-1 SM(D)	MB.PJA01.001
<b>MEMORY</b> 	1	SODIMM 1G M470T2864QZ3-CE6	KN.1GB0B.016
	1	SODIMM 1G HYMP112S64CP6-Y5	KN.1GB0G.012
	1	SODIMM 1G NT1GT64UH8D0FN-AD	KN.1GB03.025
	1	SODIMM 1G HYMP112S64CP6-S6	KN.1GB0G.016
	1	SODIMM 2G M470T5663EH3-CF7	KN.2GB0B.018
	1	SODIMM 2G HMP125S6EFR8C-Y5	KN.2GB0G.012
	1	SODIMM 2G NT2GT64U8HD0BN-AD	KN.2GB03.010
<b>MICROPHONE</b> 	2	MICROPHONE XINGMENG JV71	TBD
	2	MICROPHONE HIT JV71	TBD
<b>MISCELLANEOUS</b> 	1	JV71_7736Z_NAME_PLATE	TBD
	1	RUB CIRCLE BEZEL JV71	TBD

Category	No.	Part Name	Acer Part No.
<b>SCREWS</b>	1	ISO M2.5X6(H=0.7~0.8MM)	86.00E12.536
	1	M2.5*L10 BLACK ZN	86.00F84.73A
	1	M2.5*L5 BLACK ZN+NYLOK	86.TK501.001
	1	SCRW M2.5XL4 D4.5 T0.8 GL	86.00H59.734
	1	SCREW M2-3	86.9A522.3R0
	1	SCRW M2*4 WAFER NI	86.9A552.4R0
	1	SCREW MACH WAFER M3*L4 NI	86.9A554.4R0
	1	SCRW M2.5L3.5	86.9A563.3R5
<b>SPEAKER</b>	2	SPEAKER FG JV71 L	TBD
	2	SPEAKER ZULUX JV71 L	TBD
	2	SPEAKER FG JV71 R	TBD
	2	SPEAKER ZYLUX JV71 R	TBD

## Aspire 7540 Series FRU List

### 1. ACER\_ASPIRE 77540 UMACBK\_JV71\_TR (NO:91.4FP01.003G)

Category	No.	Part Name	Acer Part No.
<b>ADAPTER</b> 	1	ADP 65W 19V 3P HP-A0652R3B 1LF	AP.0650A.012
	1	ADP 65W 19V 3P ADP-65JH DB A,	AP.06501.026
	1	ADP 65W 19V 3P PA-1650-22AC LV	AP.06503.024
<b>BATTERY</b> 	1	BTY PACK LI+ 6C 2.2AH SANYO	BT.00603.042
	1	BTY PACK LI+ 6C 2.2AH PANA	BT.00605.021
	1	BTY PACK LI+ 6C 2.2AH SDI	BT.00606.001
	1	BTY PACK LI+ 8C 2.4AH SANYO	BT.00803.024
	1	BTY PACK LI+ 8C 2.4AH SONY	BT.00804.020
<b>BOARDS</b> 	1	BT MODULE FOXCONN BCM2046 V2.1	BH.21100.004
	1	JV71-TR FP BD W/0 FP 09587-1 D	TBD
	1	JV71-TR USB BD PD 09582-1(D)	TBD
	2	MODEM MDC FOX_LSI AM5-V2H	FX.22500.023
	1	TOUCHPAD ALPS KGDF0038A	56.PAW01.001
	1	TOUCHPAD SYNAPTICS TM00540-005	56.ATR01.001
	1	WLAN 802.11BGN Atheros HB93	NI.23600.046
	1	WLAN 802.11BGN Atheros HB93 AR	NI.23600.054
	1	WLAN 802.11BG Atheros AR9285(H)	NI.23600.047

Category	No.	Part Name	Acer Part No.
<b>CABLES</b>	1	C.A. BLUETOOTH JV71	TBD
	1	C.A. BLUETOOTH JV71(WANSH)	TBD
	1	C.A. BLUETOOTH JV71(HT)	TBD
	2	C.A. LCD JV71(MEC)	TBD
	2	C.A. LCD JV71(WANSH)	TBD
	1	C.A. USB JV71(WANSH)	TBD
	1	C.A. USB JV71(HT)	TBD
	2	CABLE RJ11 JV71	TBD
	1	CABLE USB JV71	TBD
	1	CORD USA/W CNS 2.5A 125V 8121-	27.01518.781
	1	CORD SWISS 2.5A 250V 3P BK	27.01518.581
	1	CORD 10A 250V 3P SWISS BK	27.01518.691
	1	CORD ARGENTINE,10A 250V3G,1.8M	27.01518.0U1
	1	CORD US 7A 125V BK	27.T30V1.001
	1	CORD10A 125V 3P US BK	27.01518.641
	1	CORD 7A250V 2P 1830 KOREAN	27.01518.531
	1	CORD UK 2.5A 250V 3P BK	27.01518.541
	1	CORD 5A 250V 3P UK BK	27.03118.001
	1	CORD JAPAN 7A 125V 2P BK	27.01518.551
	1	CORD DENMARK 2.5A 250V 3P BK	27.01518.561
	1	CORD10A 250V 3P DENMARK BK	27.01518.671
	1	CORDSOUTH AFRICA 16A 250V BK	27.01518.571
	1	CORD 16A 250V SOUTH AFRICA BK	27.01518.681
	1	CORD CHINA 10A 250V 3P	27.01518.591
	1	CORD 10A 250V 3P CHINA BK	27.01518.701
	1	CORD EUR 250V 3P BK	27.T30V1.004
	1	CORD 16A 250V 3P EUR BK	27.01518.731
	1	CORD ITALY 10A 250V 3P BK	27.01518.611
	1	CORD 10A 250V 3P ITALY BK	27.01518.711
	1	CORD 2.5A 250V AUSTRALIA BK	27.01518.621
	1	CORD 2.5A 250V SOUTH AFRICA BK	27.01518.631
	1	CORD 6A 250V SOUTH AFRICA BK	27.01518.721
	1	CORD 7A 125V 2P JAPAN BK	27.01518.661
	1	CORD 7.5A 250V 3P AUSTRALIA BK	27.03218.051
	1	CORD 7A 125V JAPAN 2PIN BK	27.03518.161
	1	CORD 250V 10~16A 3P ISRAEL	27.01518.761
	1	POWER CORD BRAZIL, BLK, 1.8M	27.01518.A41
	1	POWER CODE ACA / ACNZ ANNIE	27.03218.021
	1	POWER CORD TAIWANESE BLACK, 1.8	27.01518.A11
	1	JV71_FP_FFC	TBD
	1	JV71_TP_FFC	TBD
	1	TR_JV71_FP_FFC	TBD
	1	TR_JV71_TP_FFC	TBD

Category	No.	Part Name	Acer Part No.
<b>CAMERA</b> 	2	CAMERA 0.3M CNF701721004973L	57.W9401.001
	2	CAMERA 0.3M CN0314-SN30-OV03-5	57.N4401.001
<b>CASE/COVER/BRACKET ASSEMBLY</b> 	2	ASSY 60 HDD JV50	33.PAW01.003
	1	ASSY 60 NO FINGER UCASE JV71	TBD
	1	ASSY 60_LCASE_JV71	TBD
	2	ASSY 60 LCD BEZEL JV71	TBD
	2	ASSY 60 LCD PANEL JV71(1+1)	TBD
	1	ASSY JV71 TP BRKT	TBD
	1	ASSY JV71 AMD MIDDLE COVER	TBD
	1	ASSY JV71_HDD_DOR	TBD
	2	ASSY ODD BEZEL JV71	TBD
	2	HINGE LEFT ASSYJV71(LH)	TBD
	2	HINGE LEFT ASSY JV71(SZS)	TBD
	2	HINGE RIGHT ASSYJV71(LH)	TBD
	2	HINGE RIGHTT ASSY JV71(SZS)	TBD
	2	JV71_ODD_BLUE RAY_ASSY	TBD
	2	BRKT ODD JV50	33.PAW01.002
	<b>COMBO MODULE</b> 	1	SD DUMMY CARD MYALL2
2		BRKT ODD JV50	33.PAW01.002
2		BD COMBO SATA W7 PLDS DS-4E1S	KO.0040F.003
<b>CPU/PROCESSOR</b> 	2	BD COMBO SATA W7 SONY BC-5500S	KO.0040E.002
	1	ODD NBDCB4XS BD COMBO JV71_TR	
<b>CPU/PROCESSOR</b> 	1	IC CPU ATHLONII M320 2.1G 1M 3	KC.AM002.320
	1	IC CPU ATHLONII M300 2.0G 1M 3	KC.AM002.300
<b>DVD-RW DRIVE</b> 	1	ODD NSM8XS SUPER-MULTI JV71_TR	
	2	ODD SM12.7 HFW7 TSST TS-L633C	KU.00801.035
	2	ODD SM12.7 HF+W7 HLDS GT30N	KU.0080D.048

Category	No.	Part Name	Acer Part No.
<b>HDD/HARD DISK DRIVE</b> 	1	HDD N160GB5.4KS FOR JV71_TR	
	2	HDD 160GB HGST HTS545016B9A300	KH.16007.024
	2	HDD 160GB WD WD1600BEVT-22ZCT0	KH.16008.022
	1	HDD N250GB5.4KS FOR JV71_TR	
	2	HDD 250GB HGST HTS545025B9A300	KH.25007.015
	1	HDD N320GB5.4KS FOR JV71_TR	
	2	HDD 320GB HGST HTS545032B9A300	KH.32007.007
	2	HDD 320GB WD WD3200BEVT-22ZCT0	KH.32008.013
	1	HDD N500GB5.4KS FOR JV71_TR	
	2	HDD 500GB SGT ST9500325AS 5.4K	KH.50001.011
	2	HDD 500GB HGST HTS545050B9A300	KH.50007.009
	2	HDD 500GB WD5000BEVT-22ZAT0	KH.50008.013
	<b>HEATSINK</b> 	1	ASSY THERMAL JV71 TR UMA FOXS
1		ASSY THERMAL JV71 TR UMA FCVF	TBD
<b>KEYBOARD</b> 	1	KB NSK-ALA1D US-IN 103KEY AC7T	KB.I170A.056
	1	KB MP-09B23U4-442 USI 103 AC7T	KB.I170A.056
	1	KB NSK-ALA0A ARABI 103KEY AC7T	KB.I170A.032
	1	KB MP-09B23A0-442 ARA 103 AC7T	KB.I170A.032
	1	KB NSK-ALA1A BELGI 104KEY AC7T	KB.I170A.033
	1	KB MP-09B26B0-442 BEL 104 AC7T	KB.I170A.033
	1	KB NSK-ALA1B BRZ 104KEY AC7T	KB.I170A.034
	1	KB MP-09B26PA-442 BRA 104 AC7T	KB.I170A.034
	1	KB NSK-ALA13 CZ/SK 104KEY AC7T	KB.I170A.035
	1	KB MP-09B26CS-442 CZK 104 AC7T	KB.I170A.035
	1	KB NSK-ALA02 TAIWA 103KEY AC7T	KB.I170A.036
	1	KB MP-09B23RC-442 CHI 103 AC7T	KB.I170A.036
	1	KB NSK-ALA0D DANIS 104KEY AC7T	KB.I170A.037
	1	KB MP-09B26DK-442 DAN 104 AC7T	KB.I170A.037
	1	KB NSK-ALA2A FRA 104KEY AC7T	KB.I170A.038
	1	KB MP-09B26AF-442 FRA 104 AC7T	KB.I170A.038
	1	KB NSK-ALA0F FRENC 104KEY AC7T	KB.I170A.039
	1	KB MP-09B26F0-442 FRE 104 AC7T	KB.I170A.039
	1	KB NSK-ALA0G GERMA 104KEY AC7T	KB.I170A.040
	1	KB MP-09B26D0-442 GER 104 AC7T	KB.I170A.040
	1	KB NSK-ALA0L GREEK 103KEY AC7T	KB.I170A.041
	1	KB MP-09B23GR-442 GRE 103 AC7T	KB.I170A.041
	1	KB NSK-ALA0Q HUNGA 104KEY AC7T	KB.I170A.042

Category	No.	Part Name	Acer Part No.	
<b>KEYBOARD</b>	1	KB MP-09B26HU-442 HUN 104 AC7T	KB.I170A.042	
	1	KB NSK-ALA0E ITALI 104KEY AC7T	KB.I170A.043	
	1	KB MP-09B26I0-442 ITA 104 AC7T	KB.I170A.043	
	1	KB NSK-ALA0J JAPAN 107KEY AC7T	KB.I170A.044	
	1	KB MP-09B20J0-442 JAP 107 AC7T	KB.I170A.044	
	1	KB NSK-ALA1K NORDI 104KEY AC7T	KB.I170A.045	
	1	KB MP-09B26DN-442 NOD 104 AC7T	KB.I170A.045	
	1	KB NSK-ALA0N NORWE 104KEY AC7T	KB.I170A.046	
	1	KB MP-09B26N0-442 NOR 104 AC7T	KB.I170A.046	
	1	KB NSK-ALA06 PORTU 104KEY AC7T	KB.I170A.047	
	1	KB MP-09B26P0-442 POR 104 AC7T	KB.I170A.047	
	1	KB NSK-ALA0R RUSSI 103KEY AC7T	KB.I170A.048	
	1	KB MP-09B23SU-442 RUS 103 AC7T	KB.I170A.048	
	1	KB NSK-ALA1F SLOVE 104KEY AC7T	KB.I170A.049	
	1	KB MP-09B26SA-442 SLO 104 AC7T	KB.I170A.049	
	1	KB NSK-ALA0S SPANI 104KEY AC7T	KB.I170A.050	
	1	KB MP-09B26E0-442 SPA 104 AC7T	KB.I170A.050	
	1	KB NSK-ALA0W SWEDI 104KEY AC7T	KB.I170A.051	
	1	KB MP-09B26S0-442 SWE 104 AC7T	KB.I170A.051	
	1	KB NSK-ALA00 SWISS 104KEY AC7T	KB.I170A.052	
	1	KB MP-09B26CH-442 SWI 104 AC7T	KB.I170A.052	
	1	KB NSK-ALA03 THAIL 103KEY AC7T	KB.I170A.053	
	1	KB MP-09B23T0-442 THA 103 AC7T	KB.I170A.053	
	1	KB NSK-ALA0T TURKI 104KEY AC7T	KB.I170A.054	
	1	KB MP-09B26TQ-442 TUR 104 AC7T	KB.I170A.054	
	1	KB NSK-ALA0U UK 104KEY AC7T	KB.I170A.055	
	1	KB MP-09B26GB-442 UK 104 AC7T	KB.I170A.055	
	1	KB NSK-ALA0H HEBRE 103KEY AC7T	KB.I170A.057	
	1	KB MP-09B23HB-442 HEB 103 AC7T	KB.I170A.057	
	1	KB NSK-ALA2M FCE 104KEY AC7T	KB.I170A.058	
	1	KB MP-09B26CU-442 FCE 104 AC7T	KB.I170A.058	
	<b>LCD</b>	1	LCD NLED17.3WXGA+G ANT*2 W/CAM	
		2	LCD 17.3"WXGA+ LTN173KT01-A01	LK.17306.001
2		LCD 17.3"WXGA+ AU B173RW01-V0	LK.17305.001	
2		LCD 17.3"WXGA+ LP173WD1-TLA1 G	LK.17308.001	
2		LCD 17.3"WXGA+ CMO N173O6-L02	LK.1730D.001	
<b>MAINBOARD</b>	1	JV71-TR MB 09243-1 UMA PD(D)	MB.PJD01.001	



Category	No.	Part Name	Acer Part No.
<b>MEMORY</b> 	1	SODIMM 1G HYMP112S64CP6-Y5	KN.1GB0G.012
	1	SODIMM 1G NT1GT64UH8D0FN-AD	KN.1GB03.025
	1	SODIMM 1G M470T2864QZ3-CE6	KN.1GB0B.016
	1	SODIMM 1G M470T2864EH3-CF7	KN.1GB0B.033
	1	SODIMM 1G HYMP112S64CP6-S6	KN.1GB0G.016
	1	SODIMM 2G NT2GT64U8HD0BN-AD	KN.2GB03.010
	1	SODIMM 2G M470T5663QZ3-CE6	KN.2GB0B.003
	1	SODIMM 2G M470T5663EH3-CF7	KN.2GB0B.018
	1	SODIMM 2G HYMP125S64CP8-Y5	KN.2GB0G.004
<b>MICROPHONE</b> 	2	MICROPHONE XINGMENG JV71	TBD
	2	MICROPHONE HIT JV71	TBD
<b>MISCELLANEOUS</b>	1	JV71_7540_NAME_PLATE	TBD
	1	RUB CIRCLE BEZEL JV71	TBD
<b>SCREWS</b>	1	ISO M2.5X6(H=0.7~0.8MM)	86.00E12.536
	1	M2.5*L10 BLACK ZN	86.00F84.73A
	1	M2.5*L5 BLACK ZN+NYLOK	86.TK501.001
	1	SCRW M2.5XL4 D4.5 T0.8 GL	86.00H59.734
	1	SCREW M2-3	86.9A522.3R0
	1	SCRW M2*4 WAFER NI	86.9A552.4R0
	1	SCREW MACH WAFER M3*L4 NI	86.9A554.4R0
	1	SCRW M2.5L3.5	86.9A563.3R5
<b>SPEAKER</b>	2	SPEAKER FG JV71 L	TBD
	2	SPEAKER ZULUX JV71 L	TBD
	2	SPEAKER FG JV71 R	TBD
	2	SPEAKER ZYLUX JV71 R	TBD



2. ACER\_ASPIRE 7540G M92XT512CFBK\_V3\_JV71\_TR (NO: S2.PJC02.002)

Category	No.	Part Name	Acer Part No.
<b>ADAPTER</b> 	1	ADP 90W 19V 3P HP-A0904A3 B1LF	AP.0900A.005
	1	ADP 90W 19V 3P ADP-90CD DB A L	AP.09001.027
	1	ADP 90W 19V 3P PA-1900-34AR LV	AP.09003.021
<b>BATTERY</b> 	1	BTY PACK LI+ 8C 2.4AH SANYO	BT.00803.024
	1	BTY PACK LI+ 8C 2.4AH SONY	BT.00804.020
	1	BTY PACK LI+ 6C 2.2AH SANYO	BT.00603.042
	1	BTY PACK LI+ 6C 2.2AH PANA	BT.00605.021
	1	BTY PACK LI+ 6C 2.2AH SDI	BT.00606.001
<b>BOARDS</b> 	1	BT MODULE FOXCONN BCM2046 V2.1	BH.21100.004
	1	JM70-MV FPSENSOR 08647-1 BD(D)	55.PCC01.005
	1	JV71-TR FP BD W/FP 09587-1(D)	TBD
	1	JV71-TR USB BD PD 09582-1(D)	TBD
	2	MODEM MDC FOX_LSI AM5-V2H	FX.22500.023
	1	TOUCHPAD SYNAPTICS TM00540-005	56.ATR01.001
	1	TOUCHPAD ALPS KGDF0038A	56.PAW01.001
	1	WLAN 802.11BGN ATHEROS HB93 AR	NI.23600.054
	1	WLAN 802.11BGN ATHEROS HB93	NI.23600.046
	1	WLAN 802.11BG ATHEROS AR9285(H)	NI.23600.047
<b>CABLES</b> 	1	CORD USA/W CNS 2.5A 125V 8121-	27.01518.781
	1	POWER CORD TAIWANESE BLACK,1.8	27.01518.A11
	1	CORD SWISS 2.5A 250V 3P BK	27.01518.581
	1	CORD 10A 250V 3P SWISS BK	27.01518.691
	1	CORD ARGENTINE,10A 250V3G,1.8M	27.01518.0U1
	1	CORD US 7A 125V BK	27.T30V1.001
	1	CORD 10A 125V 3P US BK	27.01518.641
	1	CORD 7A250V 2P 1830 KOREAN	27.01518.531

Category	No.	Part Name	Acer Part No.
<b>CABLES</b>	1	CORD UK 2.5A 250V 3P BK	27.01518.541
	1	CORD 5A 250V 3P UK BK	27.03118.001
	1	CORD JAPAN 7A 125V 2P BK	27.01518.551
	1	CORD DENMARK 2.5A 250V 3P BK	27.01518.561
	1	CORD 10A 250V 3P DENMARK BK	27.01518.671
	1	CORD SOUTH AFRICA 16A 250V BK	27.01518.571
	1	CORD 16A 250V SOUTH AFRICA BK	27.01518.681
	1	CORD CHINA 10A 250V 3P	27.01518.591
	1	CORD 10A 250V 3P CHINA BK	27.01518.701
	1	CORD EUR 250V 3P BK	27.T30V1.004
	1	CORD 16A 250V 3P EUR BK	27.01518.731
	1	CORD ITALY 10A 250V 3P BK	27.01518.611
	1	CORD 10A 250V 3P ITALY BK	27.01518.711
	1	CORD 2.5A 250V AUSTRALIA BK	27.01518.621
	1	CORD 2.5A 250V SOUTH AFRICA BK	27.01518.631
	1	CORD 6A 250V SOUTH AFRICA BK	27.01518.721
	1	CORD 7A 125V 2P JAPAN BK	27.01518.661
	1	CORD 250V 10~16A 3P ISRAEL	27.01518.761
	1	POWER CORD BRAZIL,BLK,1.8M	27.01518.A41
	1	POWER CORD ACA / ACNZ ANNIE	27.03218.021
	1	CORD 7.5A 250V 3P AUSTRALIA BK	27.03218.051
	1	CORD 7A 125V JAPAN 2PIN BK	27.03518.161
	1	JV71_TP_FFC	TBD
	1	TR_JV71_TP_FFC	TBD
	1	JV71_FP_FFC	TBD
	1	TR_JV71_FP_FFC	TBD
	2	CABLE RJ11 JV71	TBD
	1	CABLE USB JV71	TBD
	1	C.A. BLUETOOTH JV71	TBD
	1	C.A. BLUETOOTH JV71(WANSH)	TBD
	1	C.A. BLUETOOTH JV71(HT)	TBD
	2	C.A. LCD JV71(MEC)	TBD
2	C.A. LCD JV71(WANSH)	TBD	
1	C.A. USB JV71(WANSH)	TBD	
1	C.A. USB JV71(HT)	TBD	
<b>CAMERA</b>	2	CAMERA 0.3M CN0314-SN30-OV03-5	57.N4401.001
	2	CAMERA 0.3M CNF701721004973L	57.W9401.001

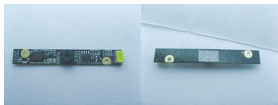

Category	No.	Part Name	Acer Part No.
<b>CASE/COVER/BRACKET ASSEMBLY</b> 	1	ASSY JV71 TP BRKT	TBD
	1	SD DUMMY CARD MYALL2	42.TKJ01.001
	1	ASSY JV71 AMD MIDDLE COVER	TBD
	1	ASSY JV71_HDD_DOR	TBD
	1	ASSY 60 FINGER UCASE JV71	TBD
	1	ASSY 60_LCASE_JV71	TBD
	1	ODD NBDCB4XS BD COMBO JV71_TR	
	2	JV71_ODD_BLUE RAY_ASSY	TBD
	2	BRKT ODD JV50	33.PAW01.002
	2	HINGE LEFT ASSYJV71(LH)	TBD
	2	HINGE LEFT ASSY JV71(SZS)	TBD
	2	HINGE RIGHT ASSYJV71(LH)	TBD
	2	HINGE RIGHTT ASSY JV71(SZS)	TBD
	2	ASSY 60 HDD JV50	33.PAW01.003
	2	ASSY 60 LCD BEZEL JV71	TBD
	2	ASSY 60 LCD PANEL JV71(1+1)	TBD
2	ASSY ODD BEZEL JV71	TBD	
<b>COMBO MODULE</b> 	2	BD COMBO SATA W7 PLDS DS-4E1S	KO.0040F.003
	2	BD COMBO SATA W7 SONY BC-5500S	KO.0040E.002
<b>CPU/PROCESSOR</b> 	1	IC CPU ATHLONII M320 2.1G 1M 3	KC.AM002.320
	1	IC CPU ATHLONII M300 2.0G 1M 3	KC.AM002.300
<b>DVD-RW DRIVE</b> 	1	ODD NSM8XS SUPER-MULTI JV71_TR	
	2	ODD SM12.7 HFW7 TSST TS-L633C	KU.00801.035
	2	ODD SM12.7 HF+W7 HLDS GT30N	KU.0080D.048
<b>HDD/HARD DISK DRIVE</b> 	1	HDD N160GB5.4KS FOR JV71_TR	
	2	HDD 160GB HGST HTS545016B9A300	KH.16007.024
	2	HDD 160GB WD WD1600BEVT-22ZCT0	KH.16008.022
	1	HDD N250GB5.4KS FOR JV71_TR	
	2	HDD 250GB HGST HTS545025B9A300	KH.25007.015
	1	HDD N320GB5.4KS FOR JV71_TR	
	2	HDD 320GB HGST HTS545032B9A300	KH.32007.007
	2	HDD 320GB WD WD3200BEVT-22ZCT0	KH.32008.013
	1	HDD N500GB5.4KS FOR JV71_TR	
	2	HDD 500GB SGT ST9500325AS 5.4K	KH.50001.011
	2	HDD 500GB HGST HTS545050B9A300	KH.50007.009
	2	HDD 500GB WD5000BEVT-22ZAT0	KH.50008.013

Category	No.	Part Name	Acer Part No.
<b>HEATSINK</b> 	1	ASSY THERMAL JV71 TR DIS FOXS	TBD
	1	ASSY THERMAL JV71 TR DIS FCVF	TBD
<b>KEYBOARD</b> 	1	KB NSK-ALA1D US-IN 103KEY AC7T	KB.I170A.056
	1	KB MP-09B23U4-442 USI 103 AC7T	KB.I170A.056
	1	KB NSK-ALA0A ARABI 103KEY AC7T	KB.I170A.032
	1	KB MP-09B23A0-442 ARA 103 AC7T	KB.I170A.032
	1	KB NSK-ALA1A BELGI 104KEY AC7T	KB.I170A.033
	1	KB MP-09B26B0-442 BEL 104 AC7T	KB.I170A.033
	1	KB NSK-ALA1B BRZ 104KEY AC7T	KB.I170A.034
	1	KB MP-09B26PA-442 BRA 104 AC7T	KB.I170A.034
	1	KB NSK-ALA13 CZ/SK 104KEY AC7T	KB.I170A.035
	1	KB MP-09B26CS-442 CZK 104 AC7T	KB.I170A.035
	1	KB NSK-ALA02 TAIWA 103KEY AC7T	KB.I170A.036
	1	KB MP-09B23RC-442 CHI 103 AC7T	KB.I170A.036
	1	KB NSK-ALA0D DANIS 104KEY AC7T	KB.I170A.037
	1	KB MP-09B26DK-442 DAN 104 AC7T	KB.I170A.037
	1	KB NSK-ALA2A FRA 104KEY AC7T	KB.I170A.038
	1	KB MP-09B26AF-442 FRA 104 AC7T	KB.I170A.038
	1	KB NSK-ALA0F FRENC 104KEY AC7T	KB.I170A.039
	1	KB MP-09B26F0-442 FRE 104 AC7T	KB.I170A.039
	1	KB NSK-ALA0G GERMA 104KEY AC7T	KB.I170A.040
	1	KB MP-09B26D0-442 GER 104 AC7T	KB.I170A.040
	1	KB NSK-ALA0L GREEK 103KEY AC7T	KB.I170A.041
	1	KB MP-09B23GR-442 GRE 103 AC7T	KB.I170A.041
	1	KB NSK-ALA0Q HUNGA 104KEY AC7T	KB.I170A.042
	1	KB MP-09B26HU-442 HUN 104 AC7T	KB.I170A.042
	1	KB NSK-ALA0E ITALI 104KEY AC7T	KB.I170A.043
	1	KB MP-09B26I0-442 ITA 104 AC7T	KB.I170A.043
	1	KB NSK-ALA0J JAPAN 107KEY AC7T	KB.I170A.044
	1	KB MP-09B20J0-442 JAP 107 AC7T	KB.I170A.044
	1	KB NSK-ALA1K NORDI 104KEY AC7T	KB.I170A.045
	1	KB MP-09B26DN-442 NOD 104 AC7T	KB.I170A.045
	1	KB NSK-ALA0N NORWE 104KEY AC7T	KB.I170A.046
	1	KB MP-09B26N0-442 NOR 104 AC7T	KB.I170A.046
	1	KB NSK-ALA06 PORTU 104KEY AC7T	KB.I170A.047
1	KB MP-09B26P0-442 POR 104 AC7T	KB.I170A.047	
1	KB NSK-ALA0R RUSSI 103KEY AC7T	KB.I170A.048	
1	KB MP-09B23SU-442 RUS 103 AC7T	KB.I170A.048	

Category	No.	Part Name	Acer Part No.
<b>KEYBOARD</b>	1	KB NSK-ALA1F SLOVE 104KEY AC7T	KB.I170A.049
	1	KB MP-09B26SA-442 SLO 104 AC7T	KB.I170A.049
	1	KB NSK-ALA0S SPANI 104KEY AC7T	KB.I170A.050
	1	KB MP-09B26E0-442 SPA 104 AC7T	KB.I170A.050
	1	KB NSK-ALA0W SWEDI 104KEY AC7T	KB.I170A.051
	1	KB MP-09B26S0-442 SWE 104 AC7T	KB.I170A.051
	1	KB NSK-ALA00 SWISS 104KEY AC7T	KB.I170A.052
	1	KB MP-09B26CH-442 SWI 104 AC7T	KB.I170A.052
	1	KB NSK-ALA03 THAIL 103KEY AC7T	KB.I170A.053
	1	KB MP-09B23T0-442 THA 103 AC7T	KB.I170A.053
	1	KB NSK-ALA0T TURKI 104KEY AC7T	KB.I170A.054
	1	KB MP-09B26TQ-442 TUR 104 AC7T	KB.I170A.054
	1	KB NSK-ALA0U UK 104KEY AC7T	KB.I170A.055
	1	KB MP-09B26GB-442 UK 104 AC7T	KB.I170A.055
	1	KB NSK-ALA0H HEBRE 103KEY AC7T	KB.I170A.057
	1	KB MP-09B23HB-442 HEB 103 AC7T	KB.I170A.057
	1	KB NSK-ALA2M FCE 104KEY AC7T	KB.I170A.058
	1	KB MP-09B26CU-442 FCE 104 AC7T	KB.I170A.058
<b>LCD</b>	1	LCD NLED17.3WXGA+G ANT*2 W/CAM	
	2	LCD 17.3" WXGA+ LP173WD1-TLA1 G	LK.17308.001
	2	LCD 17.3" WXGA+ AU B173RW01-V0	LK.17305.001
	2	LCD 17.3" WXGA+ CMO N173O6-L02	LK.1730D.001
<b>MAINBOARD</b>	1	JV71-TR MB 09243-1 PD DIS SN(D)	MB.PJC01.001
			
<b>MEMORY</b>	1	SODIMM 1G NT1GT64UH8D0FN-AD	KN.1GB03.025
	1	SODIMM 1G M470T2864QZ3-CE6	KN.1GB0B.016
	1	SODIMM 1G M470T2864EH3-CF7	KN.1GB0B.033
	1	SODIMM 1G HYMP112S64CP6-Y5	KN.1GB0G.012
	1	SODIMM 1G HYMP112S64CP6-S6	KN.1GB0G.016
	1	SODIMM 2G NT2GT64U8HD0BN-AD	KN.2GB03.010
	1	SODIMM 2G M470T5663QZ3-CE6	KN.2GB0B.003
	1	SODIMM 2G M470T5663EH3-CF7	KN.2GB0B.018
	1	SODIMM 2G HYMP125S64CP8-Y5	KN.2GB0G.004
<b>MICROPHONE</b>	2	MICROPHONE XINGMENG JV71	TBD
	2	MICROPHONE HIT JV71	TBD
			
<b>MISCELLANEOUS</b>	1	JV71_7540_NAME_PLATE	TBD
	1	RUB CIRCLE BEZEL JV71	TBD

Category	No.	Part Name	Acer Part No.
<b>SCREWS</b>	1	ISO M2.5X6(H=0.7~0.8MM)	86.00E12.536
	1	M2.5*L10 BLACK ZN	86.00F84.73A
	1	M2.5*L5 BLACK ZN+NYLOK	86.TK501.001
	1	SCRW M2.5XL4 D4.5 T0.8 GL	86.00H59.734
	1	SCREW M2-3	86.9A522.3R0
	1	SCRW M2*4 WAFER NI	86.9A552.4R0
	1	SCREW MACH WAFER M3*L4 NI	86.9A554.4R0
	1	SCRW M2.5L3.5	86.9A563.3R5
<b>SPEAKER</b>	2	SPEAKER FG JV71 L	TBD
	2	SPEAKER ZULUX JV71 L	TBD
	2	SPEAKER FG JV71 R	TBD
	2	SPEAKER ZYLUX JV71 R	TBD

# Model Definition and Configuration

---

## Aspire 7736/7736Z/7336 Series

Model	RO	Country	Acer Part No	Description	CPU	LCD	VGA Chip	VRAM 1	Memory 1/ Memory 2	HDD 1(GB)	ODD	Card Reader	Wireless LAN1	Bluetooth /Finger Print	NB Chipset	SB Chipset	Battery	Adapter	Camera
AS7736G-744G32Mn	EMEA	France	LX.PHU02.092	AS7736G-744G32Mn W7HP64ATFR1 MC N10MGS512Cbk_V3 2*2G/320/6L2.2/5R/CB_n2_0.3D_HG_FR21	C2DP7450	NLED17.3WXGA+G	N10MGS	512M-DDR3 (64*16*4)	SO2GBIi6	N320GB5.4KS	NSM8XS	5 in 1-Build in	SP1x2HMWW	N	PM45	ICH9M	6CELL.2.2	65W	0.3M DV
AS7736G-664G50Bn	EMEA	Switzerland	LX.PHU02.099	AS7736G-664G50Bn W7HP64ATCH1 MC N10MGS512Cbk_V3 2*2G/500_L/6L2.2/5R/CB_n2_0.3D_HG_IT41	C2DT6600	NLED17.3WXGA+G	N10MGS	512M-DDR3 (64*16*4)	SO2GBIi6	N500GB5.4KS	NBDCB4XS	5 in 1-Build in	SP1x2MMWW	N	PM45	ICH9M	6CELL.2.2	65W	0.3M DV
AS7736G-664G50Mn	EMEA	France	LX.PHU02.091	AS7736G-664G50Mn W7HP64ATFR1 MC N10MGS512Cbk_V3 2*2G/500_L/6L2.2/5R/CB_n2_0.3D_HG_FR21	C2DT6600	NLED17.3WXGA+G	N10MGS	512M-DDR3 (64*16*4)	SO2GBIi6	N500GB5.4KS	NSM8XS	5 in 1-Build in	SP1x2MMWW	N	PM45	ICH9M	6CELL.2.2	65W	0.3M DV
AS7736G-664G32Mn	EMEA	Turkey	LX.PHU02.104	AS7736G-664G32Mn EM W7HP64EMATTR1 MC N10MGS512Cbk_V3 2*2G/320/6L2.2/5R/CB_n2_0.3D_HG_TR31	C2DT6600	NLED17.3WXGA+G	N10MGS	512M-DDR3 (64*16*4)	SO2GBIi6	N320GB5.4KS	NSM8XS	5 in 1-Build in	SP1x2MMWW	N	PM45	ICH9M	6CELL.2.2	65W	0.3M DV
AS7736G-664G32Mn	EMEA	Switzerland	LX.PHU02.103	AS7736G-664G32Mn W7HP64ATCH1 MC N10MGS512Cbk_V3 2*2G/320/6L2.2/5R/CB_n2_0.3D_HG_IT41	C2DT6600	NLED17.3WXGA+G	N10MGS	512M-DDR3 (64*16*4)	SO2GBIi6	N320GB5.4KS	NSM8XS	5 in 1-Build in	SP1x2MMWW	N	PM45	ICH9M	6CELL.2.2	65W	0.3M DV
AS7736G-664G50Mn	EMEA	Germany	LX.PHU02.097	AS7736G-664G50Mn W7HP64ATDE1 MC N10MGS512Cbk_V3 2*2G/500_L/6L2.2/5R/CB_n2_0.3D_HG_DE11	C2DT6600	NLED17.3WXGA+G	N10MGS	512M-DDR3 (64*16*4)	SO2GBIi6	N500GB5.4KS	NSM8XS	5 in 1-Build in	SP1x2MMWW	N	PM45	ICH9M	6CELL.2.2	65W	0.3M DV
AS7736G-664G50Mn	EMEA	UK	LX.PHU02.094	AS7736G-664G50Mn W7HP64ATGB1 MC N10MGS512Cbk_V3 2*2G/500_L/6L2.2/5R/CB_n2_0.3D_N_HG_EN11	C2DT6600	NLED17.3WXGA+G	N10MGS	512M-DDR3 (64*16*4)	SO2GBIi6	N500GB5.4KS	NSM8XS	5 in 1-Build in	SP1x2MMWW	N	PM45	ICH9M	6CELL.2.2	65W	0.3M DV
AS7736G-744G50Mi	EMEA	Ukraine	LX.PHU02.002	AS7736G-744G50Mi W7HP64RUATUK1 MC N10MGS512Cbk_V3 2*2G/500_L/6L2.2/5R/CB_abg_0.3D_HG_RU61	C2DP7450	NLED17.3WXGA+G	N10MGS	512M-DDR3 (64*16*4)	SO2GBIi6	N500GB5.4KS	NSM8XS	5 in 1-Build in	SP1x2MAB G	N	PM45	ICH9M	6CELL.2.2	65W	0.3M DV
AS7736G-664G25Mi	EMEA	Ukraine	LX.PHU02.063	AS7736G-664G25Mi W7HP64RUATUK1 MC N10MGS512Cbk_V3 2*2G/250/6L2.2/5R/CB_abg_0.3D_HG_RU61	C2DT6600	NLED17.3WXGA+G	N10MGS	512M-DDR3 (64*16*4)	SO2GBIi6	N250GB5.4KS	NSM8XS	5 in 1-Build in	SP1x2MAB G	N	PM45	ICH9M	6CELL.2.2	65W	0.3M DV
AS7736G-664G50Mn	EMEA	Spain	LX.PHU02.102	AS7736G-664G50Mn W7HP64ATES1 MC N10MGS512Cbk_V3 2*2G/500_L/6L2.2/5R/CB_n2_0.3D_HG_ES51	C2DT6600	NLED17.3WXGA+G	N10MGS	512M-DDR3 (64*16*4)	SO2GBIi6	N500GB5.4KS	NSM8XS	5 in 1-Build in	SP1x2MMWW	N	PM45	ICH9M	6CELL.2.2	65W	0.3M DV
AS7736G-744G50Bn	EMEA	Switzerland	LX.PHU02.101	AS7736G-744G50Bn W7HP64ATCH1 MC N10MGS512Cbk_V3 2*2G/500_L/BT/6L2.2/5R/CB_n2_0.3D_HG_IT41	C2DP7450	NLED17.3WXGA+G	N10MGS	512M-DDR3 (64*16*4)	SO2GBIi6	N500GB5.4KS	NBDCB4XS	5 in 1-Build in	SP1x2MMWW	BT 2.1/N	PM45	ICH9M	6CELL.2.2	65W	0.3M DV
AS7736G-664G50Mn	EMEA	Germany	LX.PHU02.098	AS7736G-664G50Mn W7HP64ATDE1 MC N10MGS512Cbk_V3 2*2G/500_L/BT/6L2.2/5R/CB_n2_0.3D_HG_DE11	C2DT6600	NLED17.3WXGA+G	N10MGS	512M-DDR3 (64*16*4)	SO2GBIi6	N500GB5.4KS	NSM8XS	5 in 1-Build in	SP1x2MMWW	BT 2.1/N	PM45	ICH9M	6CELL.2.2	65W	0.3M DV
AS7736G-664G25Mn	EMEA	Middle East	LX.PHU02.053	AS7736G-664G25Mn EM W7HP64EMATME2 MC N10MGS512Cbk_V3 2*2G/50/6L2.2/5R/CB_n2_0.3D_HG_AR21	C2DT6600	NLED17.3WXGA+G	N10MGS	512M-DDR3 (64*16*4)	SO2GBIi6	N250GB5.4KS	NSM8XS	5 in 1-Build in	SP1x2MMWW	N	PM45	ICH9M	6CELL.2.2	65W	0.3M DV
AS7736G-744G50Mn	EMEA	Middle East	LX.PHU02.007	AS7736G-744G50Mn EM W7HP64EMATME2 MC N10MGS512Cbk_V3 2*2G/500_L/6L2.2/5R/CB_n2_0.3D_HG_AR21	C2DP7450	NLED17.3WXGA+G	N10MGS	512M-DDR3 (64*16*4)	SO2GBIi6	N500GB5.4KS	NSM8XS	5 in 1-Build in	SP1x2MMWW	N	PM45	ICH9M	6CELL.2.2	65W	0.3M DV
AS7736G-663G32Mn	EMEA	UK	LX.PHU02.096	AS7736G-663G32Mn W7HP64ATGB1 MC N10MGS512Cbk_V3 2G+1G/320/6L2.2/5R/CB_n2_0.3D_HG_EN11	C2DT6600	NLED17.3WXGA+G	N10MGS	512M-DDR3 (64*16*4)	SO2GBIi6	N320GB5.4KS	NSM8XS	5 in 1-Build in	SP1x2MMWW	N	PM45	ICH9M	6CELL.2.2	65W	0.3M DV
AS7736G-744G32Mn	EMEA	UK	LX.PHU02.095	AS7736G-744G32Mn W7HP64ATGB1 MC N10MGS512Cbk_V3 2*2G/320/6L2.2/5R/CB_n2_0.3D_HG_EN11	C2DP7450	NLED17.3WXGA+G	N10MGS	512M-DDR3 (64*16*4)	SO2GBIi6	N320GB5.4KS	NSM8XS	5 in 1-Build in	SP1x2MMWW	N	PM45	ICH9M	6CELL.2.2	65W	0.3M DV
AS7736G-884G50Bn	WW	WW	S2.PHU02.002	AS7736G-884G50Bn W7HP64AWW1 MC N10MGS512Cbk_V3 2*2G/500_L/BT/6L2.2/5R/CB_n2_0.3D_HG_ES62	C2DP8800	NLED17.3WXGA+G	N10MGS	512M-DDR3 (64*16*4)	SO2GBIi6	N500GB5.4KS	NBDCB4XS	5 in 1-Build in	SP1x2MMWW	BT 2.1/N	PM45	ICH9M	6CELL.2.2	65W	0.3M DV



AS7736G-884G50Bn	WW	GCTWN	S2.PHU02.001	AS7736G-884G50Bn W7HP64AWW1 MC N10MGS512Cbk_V3 2*2G/500_L/ BT/6L2.2/5R/CB_n2_0.3D_HG_ES61	C2DP8800	NLED17.3WXGA+G	N10MGS	512M-DDR3 (64*16*4)	SO2GBI6	N500GB5.4KS	NBDCB4XS	5 in 1-Build in	SP1x2MMW	BT 2.1/N	PM45	ICH9M	6CELL2.2	65W	0.3M DV
AS7736G-744G50Mn	EMEA	Germany	LX.PHU02.022	AS7736G-744G50Mn W7HP64ATDE1 MC N10MGS512Cbk_V3 2*2G/500_L/ 6L2.2/5R/CB_n2_0.3D_HG_DE11	C2DP7450	NLED17.3WXGA+G	N10MGS	512M-DDR3 (64*16*4)	SO2GBI6	N500GB5.4KS	NSM8XS	5 in 1-Build in	SP1x2MMW	N	PM45	ICH9M	6CELL2.2	65W	0.3M DV
AS7736G-744G50Mn	EMEA	Portugal	LX.PHU02.023	AS7736G-744G50Mn W7HP64ATPT1 MC N10MGS512Cbk_V3 2*2G/500_L/ 6L2.2/5R/CB_n2_0.3D_HG_PT11	C2DP7450	NLED17.3WXGA+G	N10MGS	512M-DDR3 (64*16*4)	SO2GBI6	N500GB5.4KS	NSM8XS	5 in 1-Build in	SP1x2MMW	N	PM45	ICH9M	6CELL2.2	65W	0.3M DV
AS7736G-744G50Mn	EMEA	Norway	LX.PHU02.021	AS7736G-744G50Mn W7HP64ATNO3 MC N10MGS512Cbk_V3 2*2G/500_L/ 6L2.2/5R/CB_n2_0.3D_HG_ENS1	C2DP7450	NLED17.3WXGA+G	N10MGS	512M-DDR3 (64*16*4)	SO2GBI6	N500GB5.4KS	NSM8XS	5 in 1-Build in	SP1x2MMW	N	PM45	ICH9M	6CELL2.2	65W	0.3M DV
AS7736G-744G50Mn	EMEA	Denmark	LX.PHU02.026	AS7736G-744G50Mn W7HP64ATDK2 MC N10MGS512Cbk_V3 2*2G/500_L/ 6L2.2/5R/CB_n2_0.3D_HG_ENS1	C2DP7450	NLED17.3WXGA+G	N10MGS	512M-DDR3 (64*16*4)	SO2GBI6	N500GB5.4KS	NSM8XS	5 in 1-Build in	SP1x2MMW	N	PM45	ICH9M	6CELL2.2	65W	0.3M DV
AS7736G-744G50Mn	EMEA	Denmark	LX.PHU02.030	AS7736G-744G50Mn W7HP64ATDK1 MC N10MGS512Cbk_V3 2*2G/500_L/ 6L2.2/5R/CB_n2_0.3D_HG_NO11	C2DP7450	NLED17.3WXGA+G	N10MGS	512M-DDR3 (64*16*4)	SO2GBI6	N500GB5.4KS	NSM8XS	5 in 1-Build in	SP1x2MMW	N	PM45	ICH9M	6CELL2.2	65W	0.3M DV
AS7736G-744G50Mn	EMEA	Hungary	LX.PHU02.024	AS7736G-744G50Mn W7HP64ATHU1 MC N10MGS512Cbk_V3 2*2G/500_L/ 6L2.2/5R/CB_n2_0.3D_HG_HU11	C2DP7450	NLED17.3WXGA+G	N10MGS	512M-DDR3 (64*16*4)	SO2GBI6	N500GB5.4KS	NSM8XS	5 in 1-Build in	SP1x2MMW	N	PM45	ICH9M	6CELL2.2	65W	0.3M DV
AS7736G-744G50Mn	EMEA	Spain	LX.PHU02.025	AS7736G-744G50Mn W7HP64ATES1 MC N10MGS512Cbk_V3 2*2G/500_L/ 6L2.2/5R/CB_n2_0.3D_HG_ES1	C2DP7450	NLED17.3WXGA+G	N10MGS	512M-DDR3 (64*16*4)	SO2GBI6	N500GB5.4KS	NSM8XS	5 in 1-Build in	SP1x2MMW	N	PM45	ICH9M	6CELL2.2	65W	0.3M DV
AS7736G-664G25Mn	EMEA	Serbia/ Macedonia	LX.PHU02.046	AS7736G-664G25Mn EM W7HP64ATCS1 MC N10MGS512Cbk_V3 2*2G/250/6L2.2/ 5R/CB_n2_0.3D_HG_SL11	C2DT6600	NLED17.3WXGA+G	N10MGS	512M-DDR3 (64*16*4)	SO2GBI6	N250GB5.4KS	NSM8XS	5 in 1-Build in	SP1x2MMW	N	PM45	ICH9M	6CELL2.2	65W	0.3M DV
AS7736G-744G50Mn	EMEA	Eastern Europe	LX.PHU02.029	AS7736G-744G50Mn W7HP64ATEU5 MC N10MGS512Cbk_V3 2*2G/500_L/ 6L2.2/5R/CB_n2_0.3D_HG_RO11	C2DP7450	NLED17.3WXGA+G	N10MGS	512M-DDR3 (64*16*4)	SO2GBI6	N500GB5.4KS	NSM8XS	5 in 1-Build in	SP1x2MMW	N	PM45	ICH9M	6CELL2.2	65W	0.3M DV
AS7736G-744G50Mn	EMEA	Switzerland	LX.PHU02.035	AS7736G-744G50Mn W7HP64ATCH1 MC N10MGS512Cbk_V3 2*2G/500_L/ 6L2.2/5R/CB_n2_0.3D_HG_IT41	C2DP7450	NLED17.3WXGA+G	N10MGS	512M-DDR3 (64*16*4)	SO2GBI6	N500GB5.4KS	NSM8XS	5 in 1-Build in	SP1x2MMW	N	PM45	ICH9M	6CELL2.2	65W	0.3M DV
AS7736G-744G50Mn	EMEA	Holland	LX.PHU02.032	AS7736G-744G50Mn W7HP64ATNL1 MC N10MGS512Cbk_V3 2*2G/500_L/ 6L2.2/5R/CB_n2_0.3D_HG_NL11	C2DP7450	NLED17.3WXGA+G	N10MGS	512M-DDR3 (64*16*4)	SO2GBI6	N500GB5.4KS	NSM8XS	5 in 1-Build in	SP1x2MMW	N	PM45	ICH9M	6CELL2.2	65W	0.3M DV
AS7736G-744G50Mn	EMEA	Poland	LX.PHU02.028	AS7736G-744G50Mn W7HP64ATPL1 MC N10MGS512Cbk_V3 2*2G/500_L/ 6L2.2/5R/CB_n2_0.3D_HG_PL11	C2DP7450	NLED17.3WXGA+G	N10MGS	512M-DDR3 (64*16*4)	SO2GBI6	N500GB5.4KS	NSM8XS	5 in 1-Build in	SP1x2MMW	N	PM45	ICH9M	6CELL2.2	65W	0.3M DV
AS7736G-744G50Mn	EMEA	Greece	LX.PHU02.031	AS7736G-744G50Mn W7HP64ATGR1 MC N10MGS512Cbk_V3 2*2G/500_L/ 6L2.2/5R/CB_n2_0.3D_HG_EL31	C2DP7450	NLED17.3WXGA+G	N10MGS	512M-DDR3 (64*16*4)	SO2GBI6	N500GB5.4KS	NSM8XS	5 in 1-Build in	SP1x2MMW	N	PM45	ICH9M	6CELL2.2	65W	0.3M DV
AS7736G-744G50Mn	EMEA	Belgium	LX.PHU02.027	AS7736G-744G50Mn W7HP64ATBE1 MC N10MGS512Cbk_V3 2*2G/500_L/ 6L2.2/5R/CB_n2_0.3D_HG_NL11	C2DP7450	NLED17.3WXGA+G	N10MGS	512M-DDR3 (64*16*4)	SO2GBI6	N500GB5.4KS	NSM8XS	5 in 1-Build in	SP1x2MMW	N	PM45	ICH9M	6CELL2.2	65W	0.3M DV
AS7736G-744G50Mn	EMEA	Eastern Europe	LX.PHU02.034	AS7736G-744G50Mn W7HP64ATEU5 MC N10MGS512Cbk_V3 2*2G/500_L/ 6L2.2/5R/CB_n2_0.3D_HG_PL71	C2DP7450	NLED17.3WXGA+G	N10MGS	512M-DDR3 (64*16*4)	SO2GBI6	N500GB5.4KS	NSM8XS	5 in 1-Build in	SP1x2MMW	N	PM45	ICH9M	6CELL2.2	65W	0.3M DV
AS7736G-664G25Mn	EMEA	Israel	LX.PHU02.048	AS7736G-664G25Mn W7HP64ATIL1 MC N10MGS512Cbk_V3 2*2G/250/ 6L2.2/5R/CB_n2_0.3D_HG_HE11	C2DT6600	NLED17.3WXGA+G	N10MGS	512M-DDR3 (64*16*4)	SO2GBI6	N250GB5.4KS	NSM8XS	5 in 1-Build in	SP1x2MMW	N	PM45	ICH9M	6CELL2.2	65W	0.3M DV
AS7736G-664G25Mn	EMEA	Israel	LX.PHU02.047	AS7736G-664G25Mn W7HP64ATIL1 MC N10MGS512Cbk_V3 2*2G/250/ 6L2.2/5R/CB_n2_0.3D_HG_HE31	C2DT6600	NLED17.3WXGA+G	N10MGS	512M-DDR3 (64*16*4)	SO2GBI6	N250GB5.4KS	NSM8XS	5 in 1-Build in	SP1x2MMW	N	PM45	ICH9M	6CELL2.2	65W	0.3M DV
AS7736G-664G25Mi	EMEA	Russia	LX.PHU02.062	AS7736G-664G25Mi W7HP64RUATRU1 MC N10MGS512Cbk_V3 2*2G/250/6L2.2/ 5R/CB_abg_0.3D_HG_RU11	C2DT6600	NLED17.3WXGA+G	N10MGS	512M-DDR3 (64*16*4)	SO2GBI6	N250GB5.4KS	NSM8XS	5 in 1-Build in	SP1x2MAB G	N	PM45	ICH9M	6CELL2.2	65W	0.3M DV
AS7736G-664G25Mn	EMEA	Algeria	LX.PHU02.049	AS7736G-664G25Mn EM W7HP64EMATDZ1 MC N10MGS512Cbk_V3 2*2G/250/6L2.2/ 5R/CB_n2_0.3D_HG_ES81	C2DT6600	NLED17.3WXGA+G	N10MGS	512M-DDR3 (64*16*4)	SO2GBI6	N250GB5.4KS	NSM8XS	5 in 1-Build in	SP1x2MMW	N	PM45	ICH9M	6CELL2.2	65W	0.3M DV

AS7736G-664G25Mn	EMEA	South Africa	LX.PHU02.055	AS7736G-664G25Mn EM W7HP64EMATZA1 MC N10MGSS12Cbk_V3 2*2G/250/6L2.2/ 5R/CB_n2_0.3D_HG_ES61	C2DT6600	NLED17.3WXGA+G	N10MGS	512M-DDR3 (64*16*4)	SO2GBIi6	N250GB5.4KS	NSM8XS	5 in 1- Build in	SP1x2MMW	N	PM45	ICH9M	6CELL2.2	65W	0.3M DV
AS7736G-664G25Mn	EMEA	Middle East	LX.PHU02.050	AS7736G-664G25Mn EM W7HP64EMATME4 MC N10MGSS12Cbk_V3 2*2G/250/6L2.2/ 5R/CB_n2_0.3D_HG_RU61	C2DT6600	NLED17.3WXGA+G	N10MGS	512M-DDR3 (64*16*4)	SO2GBIi6	N250GB5.4KS	NSM8XS	5 in 1- Build in	SP1x2MMW	N	PM45	ICH9M	6CELL2.2	65W	0.3M DV
AS7736G-664G25Mn	EMEA	Middle East	LX.PHU02.054	AS7736G-664G25Mn EM W7HP64EMATME2 MC N10MGSS12Cbk_V3 2*2G/250/6L2.2/ 5R/CB_n2_0.3D_HG_ES61	C2DT6600	NLED17.3WXGA+G	N10MGS	512M-DDR3 (64*16*4)	SO2GBIi6	N250GB5.4KS	NSM8XS	5 in 1- Build in	SP1x2MMW	N	PM45	ICH9M	6CELL2.2	65W	0.3M DV
AS7736G-664G25Mn	EMEA	South Africa	LX.PHU02.051	AS7736G-664G25Mn EM W7HP64EMATZA4 MC N10MGSS12Cbk_V3 2*2G/250/6L2.2/ 5R/CB_n2_0.3D_HG_ES61	C2DT6600	NLED17.3WXGA+G	N10MGS	512M-DDR3 (64*16*4)	SO2GBIi6	N250GB5.4KS	NSM8XS	5 in 1- Build in	SP1x2MMW	N	PM45	ICH9M	6CELL2.2	65W	0.3M DV
AS7736G-664G25Mn	EMEA	Middle East	LX.PHU02.052	AS7736G-664G25Mn EM W7HP64EMATME3 MC N10MGSS12Cbk_V3 2*2G/250/6L2.2/ 5R/CB_n2_0.3D_HG_ES61	C2DT6600	NLED17.3WXGA+G	N10MGS	512M-DDR3 (64*16*4)	SO2GBIi6	N250GB5.4KS	NSM8XS	5 in 1- Build in	SP1x2MMW	N	PM45	ICH9M	6CELL2.2	65W	0.3M DV
AS7736G-664G25Mn	EMEA	Turkey	LX.PHU02.056	AS7736G-664G25Mn EM W7HP64EMATTR1 MC N10MGSS12Cbk_V3 2*2G/250/6L2.2/ 5R/CB_n2_0.3D_HG_TR31	C2DT6600	NLED17.3WXGA+G	N10MGS	512M-DDR3 (64*16*4)	SO2GBIi6	N250GB5.4KS	NSM8XS	5 in 1- Build in	SP1x2MMW	N	PM45	ICH9M	6CELL2.2	65W	0.3M DV
AS7736G-664G25Mn	EMEA	Middle East	LX.PHU02.058	AS7736G-664G25Mn EM W7HP64EMATME9 MC N10MGSS12Cbk_V3 2*2G/250/6L2.2/ 5R/CB_n2_0.3D_HG_ES61	C2DT6600	NLED17.3WXGA+G	N10MGS	512M-DDR3 (64*16*4)	SO2GBIi6	N250GB5.4KS	NSM8XS	5 in 1- Build in	SP1x2MMW	N	PM45	ICH9M	6CELL2.2	65W	0.3M DV
AS7736G-664G25Mn	EMEA	Middle East	LX.PHU02.061	AS7736G-664G25Mn EM W7HP64EMATME2 MC N10MGSS12Cbk_V3 2*2G/250/6L2.2/ 5R/CB_n2_0.3D_HG_AR11	C2DT6600	NLED17.3WXGA+G	N10MGS	512M-DDR3 (64*16*4)	SO2GBIi6	N250GB5.4KS	NSM8XS	5 in 1- Build in	SP1x2MMW	N	PM45	ICH9M	6CELL2.2	65W	0.3M DV
AS7736G-664G25Mn	EMEA	Middle East	LX.PHU02.059	AS7736G-664G25Mn EM W7HP64EMATME4 MC N10MGSS12Cbk_V3 2*2G/250/6L2.2/ 5R/CB_n2_0.3D_HG_ES61	C2DT6600	NLED17.3WXGA+G	N10MGS	512M-DDR3 (64*16*4)	SO2GBIi6	N250GB5.4KS	NSM8XS	5 in 1- Build in	SP1x2MMW	N	PM45	ICH9M	6CELL2.2	65W	0.3M DV
AS7736G-664G25Mn	EMEA	South Africa	LX.PHU02.057	AS7736G-664G25Mn EM W7HP64EMATZA2 MC N10MGSS12Cbk_V3 2*2G/250/6L2.2/ 5R/CB_n2_0.3D_HG_ES61	C2DT6600	NLED17.3WXGA+G	N10MGS	512M-DDR3 (64*16*4)	SO2GBIi6	N250GB5.4KS	NSM8XS	5 in 1- Build in	SP1x2MMW	N	PM45	ICH9M	6CELL2.2	65W	0.3M DV
AS7736G-664G25Mn	EMEA	Sweden	LX.PHU02.066	AS7736G-664G25Mn W7HP64ATSE1 MC N10MGSS12Cbk_V3 2*2G/250/ 6L2.2/5R/CB_n2_0.3D_HG_FI11	C2DT6600	NLED17.3WXGA+G	N10MGS	512M-DDR3 (64*16*4)	SO2GBIi6	N250GB5.4KS	NSM8XS	5 in 1- Build in	SP1x2MMW	N	PM45	ICH9M	6CELL2.2	65W	0.3M DV
AS7736G-664G25Mn	EMEA	Eastern Europe	LX.PHU02.065	AS7736G-664G25Mn W7HP64ATEU7 MC N10MGSS12Cbk_V3 2*2G/250/ 6L2.2/5R/CB_n2_0.3D_HG_ENQ1	C2DT6600	NLED17.3WXGA+G	N10MGS	512M-DDR3 (64*16*4)	SO2GBIi6	N250GB5.4KS	NSM8XS	5 in 1- Build in	SP1x2MMW	N	PM45	ICH9M	6CELL2.2	65W	0.3M DV
AS7736G-664G25Mn	EMEA	Luxembourg	LX.PHU02.067	AS7736G-664G25Mn W7HP64ATLUS3 MC N10MGSS12Cbk_V3 2*2G/250/ 6L2.2/5R/CB_n2_0.3D_HG_IT41	C2DT6600	NLED17.3WXGA+G	N10MGS	512M-DDR3 (64*16*4)	SO2GBIi6	N250GB5.4KS	NSM8XS	5 in 1- Build in	SP1x2MMW	N	PM45	ICH9M	6CELL2.2	65W	0.3M DV
AS7736G-664G25Mn	EMEA	Eastern Europe	LX.PHU02.064	AS7736G-664G25Mn W7HP64ATEU7 MC N10MGSS12Cbk_V3 2*2G/250/ 6L2.2/5R/CB_n2_0.3D_HG_SL11	C2DT6600	NLED17.3WXGA+G	N10MGS	512M-DDR3 (64*16*4)	SO2GBIi6	N250GB5.4KS	NSM8XS	5 in 1- Build in	SP1x2MMW	N	PM45	ICH9M	6CELL2.2	65W	0.3M DV
AS7736G-664G25Mn	EMEA	Middle East	LX.PHU02.060	AS7736G-664G25Mn EM W7HP64EMATME6 MC N10MGSS12Cbk_V3 2*2G/250/6L2.2/ 5R/CB_n2_0.3D_HG_ES61	C2DT6600	NLED17.3WXGA+G	N10MGS	512M-DDR3 (64*16*4)	SO2GBIi6	N250GB5.4KS	NSM8XS	5 in 1- Build in	SP1x2MMW	N	PM45	ICH9M	6CELL2.2	65W	0.3M DV
AS7736G-664G25Mn	EMEA	Finland	LX.PHU02.070	AS7736G-664G25Mn W7HP64ATFI2 MC N10MGSS12Cbk_V3 2*2G/250/ 6L2.2/5R/CB_n2_0.3D_HG_FI11	C2DT6600	NLED17.3WXGA+G	N10MGS	512M-DDR3 (64*16*4)	SO2GBIi6	N250GB5.4KS	NSM8XS	5 in 1- Build in	SP1x2MMW	N	PM45	ICH9M	6CELL2.2	65W	0.3M DV
AS7736G-664G25Mn	EMEA	Italy	LX.PHU02.069	AS7736G-664G25Mn W7HP64ATTI1 MC N10MGSS12Cbk_V3 2*2G/250/ 6L2.2/5R/CB_n2_0.3D_HG_IT11	C2DT6600	NLED17.3WXGA+G	N10MGS	512M-DDR3 (64*16*4)	SO2GBIi6	N250GB5.4KS	NSM8XS	5 in 1- Build in	SP1x2MMW	N	PM45	ICH9M	6CELL2.2	65W	0.3M DV
AS7736G-664G25Mn	EMEA	Cyprus	LX.PHU02.068	AS7736G-664G25Mn W7HP64ATCY1 MC N10MGSS12Cbk_V3 2*2G/250/ 6L2.2/5R/CB_n2_0.3D_HG_ES61	C2DT6600	NLED17.3WXGA+G	N10MGS	512M-DDR3 (64*16*4)	SO2GBIi6	N250GB5.4KS	NSM8XS	5 in 1- Build in	SP1x2MMW	N	PM45	ICH9M	6CELL2.2	65W	0.3M DV

AS7736G-664G25Mn	EMEA	Austria	LX.PHU02.074	AS7736G-664G25Mn W7HP64ATAT1 MC N10MGS512Cbk_V3 2*2G/250/ 6L2.2/5R/CB_n2_0.3D_HG_DE81	C2DT6600	NLED17.3WXGA+G	N10MGS	512M-DDR3 (64*16*4)	SO2GBI6	N250GB5.4KS	NSM8XS	5 in 1- Build in	SP1x2MMW	N	PM45	ICH9M	6CELL2.2	65W	0.3M DV
AS7736G-664G25Mn	EMEA	Norway	LX.PHU02.072	AS7736G-664G25Mn W7HP64ATN01 MC N10MGS512Cbk_V3 2*2G/250/ 6L2.2/5R/CB_n2_0.3D_HG_NO11	C2DT6600	NLED17.3WXGA+G	N10MGS	512M-DDR3 (64*16*4)	SO2GBI6	N250GB5.4KS	NSM8XS	5 in 1- Build in	SP1x2MMW	N	PM45	ICH9M	6CELL2.2	65W	0.3M DV
AS7736G-664G25Mn	EMEA	Czech	LX.PHU02.071	AS7736G-664G25Mn W7HP64ATCZ2 MC N10MGS512Cbk_V3 2*2G/250/ 6L2.2/5R/CB_n2_0.3D_HG_SK11	C2DT6600	NLED17.3WXGA+G	N10MGS	512M-DDR3 (64*16*4)	SO2GBI6	N250GB5.4KS	NSM8XS	5 in 1- Build in	SP1x2MMW	N	PM45	ICH9M	6CELL2.2	65W	0.3M DV
AS7736G-664G25Mn	EMEA	Eastern Europe	LX.PHU02.073	AS7736G-664G25Mn W7HP64ATEU4 MC N10MGS512Cbk_V3 2*2G/250/ 6L2.2/5R/CB_n2_0.3D_HG_SV21	C2DT6600	NLED17.3WXGA+G	N10MGS	512M-DDR3 (64*16*4)	SO2GBI6	N250GB5.4KS	NSM8XS	5 in 1- Build in	SP1x2MMW	N	PM45	ICH9M	6CELL2.2	65W	0.3M DV
AS7736G-664G25Mn	EMEA	UK	LX.PHU02.075	AS7736G-664G25Mn W7HP64ATGB1 MC N10MGS512Cbk_V3 2*2G/250/ 6L2.2/5R/CB_n2_0.3D_HG_EN11	C2DT6600	NLED17.3WXGA+G	N10MGS	512M-DDR3 (64*16*4)	SO2GBI6	N250GB5.4KS	NSM8XS	5 in 1- Build in	SP1x2MMW	N	PM45	ICH9M	6CELL2.2	65W	0.3M DV
AS7736G-664G25Mn	EMEA	Germany	LX.PHU02.078	AS7736G-664G25Mn W7HP64ATDE1 MC N10MGS512Cbk_V3 2*2G/250/ 6L2.2/5R/CB_n2_0.3D_HG_DE11	C2DT6600	NLED17.3WXGA+G	N10MGS	512M-DDR3 (64*16*4)	SO2GBI6	N250GB5.4KS	NSM8XS	5 in 1- Build in	SP1x2MMW	N	PM45	ICH9M	6CELL2.2	65W	0.3M DV
AS7736G-664G25Mn	EMEA	France	LX.PHU02.076	AS7736G-664G25Mn W7HP64ATFR1 MC N10MGS512Cbk_V3 2*2G/250/ 6L2.2/5R/CB_n2_0.3D_HG_FR21	C2DT6600	NLED17.3WXGA+G	N10MGS	512M-DDR3 (64*16*4)	SO2GBI6	N250GB5.4KS	NSM8XS	5 in 1- Build in	SP1x2MMW	N	PM45	ICH9M	6CELL2.2	65W	0.3M DV
AS7736G-664G25Mn	EMEA	Norway	LX.PHU02.077	AS7736G-664G25Mn W7HP64ATN03 MC N10MGS512Cbk_V3 2*2G/250/ 6L2.2/5R/CB_n2_0.3D_HG_ENS1	C2DT6600	NLED17.3WXGA+G	N10MGS	512M-DDR3 (64*16*4)	SO2GBI6	N250GB5.4KS	NSM8XS	5 in 1- Build in	SP1x2MMW	N	PM45	ICH9M	6CELL2.2	65W	0.3M DV
AS7736G-664G25Mn	EMEA	Spain	LX.PHU02.081	AS7736G-664G25Mn W7HP64ATES1 MC N10MGS512Cbk_V3 2*2G/250/ 6L2.2/5R/CB_n2_0.3D_HG_ES11	C2DT6600	NLED17.3WXGA+G	N10MGS	512M-DDR3 (64*16*4)	SO2GBI6	N250GB5.4KS	NSM8XS	5 in 1- Build in	SP1x2MMW	N	PM45	ICH9M	6CELL2.2	65W	0.3M DV
AS7736G-664G25Mn	EMEA	Denmark	LX.PHU02.080	AS7736G-664G25Mn W7HP64ATDK2 MC N10MGS512Cbk_V3 2*2G/250/ 6L2.2/5R/CB_n2_0.3D_HG_ENS1	C2DT6600	NLED17.3WXGA+G	N10MGS	512M-DDR3 (64*16*4)	SO2GBI6	N250GB5.4KS	NSM8XS	5 in 1- Build in	SP1x2MMW	N	PM45	ICH9M	6CELL2.2	65W	0.3M DV
AS7736G-664G25Mn	EMEA	Hungary	LX.PHU02.082	AS7736G-664G25Mn W7HP64ATHU1 MC N10MGS512Cbk_V3 2*2G/250/ 6L2.2/5R/CB_n2_0.3D_HG_HU11	C2DT6600	NLED17.3WXGA+G	N10MGS	512M-DDR3 (64*16*4)	SO2GBI6	N250GB5.4KS	NSM8XS	5 in 1- Build in	SP1x2MMW	N	PM45	ICH9M	6CELL2.2	65W	0.3M DV
AS7736G-664G25Mn	EMEA	Denmark	LX.PHU02.083	AS7736G-664G25Mn W7HP64ATDK1 MC N10MGS512Cbk_V3 2*2G/250/ 6L2.2/5R/CB_n2_0.3D_HG_NO11	C2DT6600	NLED17.3WXGA+G	N10MGS	512M-DDR3 (64*16*4)	SO2GBI6	N250GB5.4KS	NSM8XS	5 in 1- Build in	SP1x2MMW	N	PM45	ICH9M	6CELL2.2	65W	0.3M DV
AS7736G-664G25Mn	EMEA	Portugal	LX.PHU02.079	AS7736G-664G25Mn W7HP64ATPT1 MC N10MGS512Cbk_V3 2*2G/250/ 6L2.2/5R/CB_n2_0.3D_HG_PT11	C2DT6600	NLED17.3WXGA+G	N10MGS	512M-DDR3 (64*16*4)	SO2GBI6	N250GB5.4KS	NSM8XS	5 in 1- Build in	SP1x2MMW	N	PM45	ICH9M	6CELL2.2	65W	0.3M DV
AS7736G-664G25Mn	EMEA	Belgium	LX.PHU02.086	AS7736G-664G25Mn W7HP64ATBE1 MC N10MGS512Cbk_V3 2*2G/250/ 6L2.2/5R/CB_n2_0.3D_HG_NL11	C2DT6600	NLED17.3WXGA+G	N10MGS	512M-DDR3 (64*16*4)	SO2GBI6	N250GB5.4KS	NSM8XS	5 in 1- Build in	SP1x2MMW	N	PM45	ICH9M	6CELL2.2	65W	0.3M DV
AS7736G-664G25Mn	EMEA	Poland	LX.PHU02.085	AS7736G-664G25Mn W7HP64ATPL1 MC N10MGS512Cbk_V3 2*2G/250/ 6L2.2/5R/CB_n2_0.3D_HG_PL11	C2DT6600	NLED17.3WXGA+G	N10MGS	512M-DDR3 (64*16*4)	SO2GBI6	N250GB5.4KS	NSM8XS	5 in 1- Build in	SP1x2MMW	N	PM45	ICH9M	6CELL2.2	65W	0.3M DV
AS7736G-664G25Mn	EMEA	Eastern Europe	LX.PHU02.084	AS7736G-664G25Mn W7HP64ATEU5 MC N10MGS512Cbk_V3 2*2G/250/ 6L2.2/5R/CB_n2_0.3D_HG_RO11	C2DT6600	NLED17.3WXGA+G	N10MGS	512M-DDR3 (64*16*4)	SO2GBI6	N250GB5.4KS	NSM8XS	5 in 1- Build in	SP1x2MMW	N	PM45	ICH9M	6CELL2.2	65W	0.3M DV
AS7736G-664G25Mn	EMEA	Greece	LX.PHU02.087	AS7736G-664G25Mn W7HP64ATGR1 MC N10MGS512Cbk_V3 2*2G/250/ 6L2.2/5R/CB_n2_0.3D_HG_EL31	C2DT6600	NLED17.3WXGA+G	N10MGS	512M-DDR3 (64*16*4)	SO2GBI6	N250GB5.4KS	NSM8XS	5 in 1- Build in	SP1x2MMW	N	PM45	ICH9M	6CELL2.2	65W	0.3M DV
AS7736G-664G25Mn	EMEA	Eastern Europe	LX.PHU02.090	AS7736G-664G25Mn W7HP64ATEU5 MC N10MGS512Cbk_V3 2*2G/250/ 6L2.2/5R/CB_n2_0.3D_HG_PL71	C2DT6600	NLED17.3WXGA+G	N10MGS	512M-DDR3 (64*16*4)	SO2GBI6	N250GB5.4KS	NSM8XS	5 in 1- Build in	SP1x2MMW	N	PM45	ICH9M	6CELL2.2	65W	0.3M DV
AS7736G-664G25Mn	EMEA	Switzerland	LX.PHU02.089	AS7736G-664G25Mn W7HP64ATCH1 MC N10MGS512Cbk_V3 2*2G/250/ 6L2.2/5R/CB_n2_0.3D_HG_IT41	C2DT6600	NLED17.3WXGA+G	N10MGS	512M-DDR3 (64*16*4)	SO2GBI6	N250GB5.4KS	NSM8XS	5 in 1- Build in	SP1x2MMW	N	PM45	ICH9M	6CELL2.2	65W	0.3M DV
AS7736G-664G25Mn	EMEA	Holland	LX.PHU02.088	AS7736G-664G25Mn W7HP64ATNL1 MC N10MGS512Cbk_V3 2*2G/250/ 6L2.2/5R/CB_n2_0.3D_HG_NL11	C2DT6600	NLED17.3WXGA+G	N10MGS	512M-DDR3 (64*16*4)	SO2GBI6	N250GB5.4KS	NSM8XS	5 in 1- Build in	SP1x2MMW	N	PM45	ICH9M	6CELL2.2	65W	0.3M DV

AS7736G-744G50Mn	EMEA	Serbia/Macedonia	LX.PHU02.016	AS7736G-744G50Mn EM W7HP64ATCS1 MC N10MGS512Cbk_V3 2*2G/500_L/ 6L2.2/5R/CB_n2_0.3D_HG_SL11	C2DP7450	NLED17.3WXGA+G	N10MGS	512M-DDR3 (64*16*4)	SO2GBIi6	N500GB5.4KS	NSM8XS	5 in 1-Build in	SP1x2MMW	N	PM45	ICH9M	6CELL2.2	65W	0.3M DV
AS7736G-744G50Mn	EMEA	Israel	LX.PHU02.018	AS7736G-744G50Mn W7HP64ATL1 MC N10MGS512Cbk_V3 2*2G/500_L/ 6L2.2/5R/CB_n2_0.3D_HG_HE11	C2DP7450	NLED17.3WXGA+G	N10MGS	512M-DDR3 (64*16*4)	SO2GBIi6	N500GB5.4KS	NSM8XS	5 in 1-Build in	SP1x2MMW	N	PM45	ICH9M	6CELL2.2	65W	0.3M DV
AS7736G-744G50Mi	EMEA	Russia	LX.PHU02.001	AS7736G-744G50Mi W7HP64RUATRU1 MC N10MGS512Cbk_V3 2*2G/500_L/ 6L2.2/5R/CB_nbg_0.3D_HG_RU11	C2DP7450	NLED17.3WXGA+G	N10MGS	512M-DDR3 (64*16*4)	SO2GBIi6	N500GB5.4KS	NSM8XS	5 in 1-Build in	SP1x2MAB G	N	PM45	ICH9M	6CELL2.2	65W	0.3M DV
AS7736G-744G50Mn	EMEA	Israel	LX.PHU02.017	AS7736G-744G50Mn W7HP64ATL1 MC N10MGS512Cbk_V3 2*2G/500_L/ 6L2.2/5R/CB_n2_0.3D_HG_HE31	C2DP7450	NLED17.3WXGA+G	N10MGS	512M-DDR3 (64*16*4)	SO2GBIi6	N500GB5.4KS	NSM8XS	5 in 1-Build in	SP1x2MMW	N	PM45	ICH9M	6CELL2.2	65W	0.3M DV
AS7736G-744G50Mn	EMEA	Algeria	LX.PHU02.003	AS7736G-744G50Mn EM W7HP64EMATDZ1 MC N10MGS512Cbk_V3 2*2G/500_L/ 6L2.2/5R/CB_n2_0.3D_HG_ES81	C2DP7450	NLED17.3WXGA+G	N10MGS	512M-DDR3 (64*16*4)	SO2GBIi6	N500GB5.4KS	NSM8XS	5 in 1-Build in	SP1x2MMW	N	PM45	ICH9M	6CELL2.2	65W	0.3M DV
AS7736G-744G50Mn	EMEA	South Africa	LX.PHU02.004	AS7736G-744G50Mn EM W7HP64EMATZA1 MC N10MGS512Cbk_V3 2*2G/500_L/ 6L2.2/5R/CB_n2_0.3D_HG_ES81	C2DP7450	NLED17.3WXGA+G	N10MGS	512M-DDR3 (64*16*4)	SO2GBIi6	N500GB5.4KS	NSM8XS	5 in 1-Build in	SP1x2MMW	N	PM45	ICH9M	6CELL2.2	65W	0.3M DV
AS7736G-744G50Mn	EMEA	Middle East	LX.PHU02.009	AS7736G-744G50Mn EM W7HP64EMATME2 MC N10MGS512Cbk_V3 2*2G/500_L/ 6L2.2/5R/CB_n2_0.3D_HG_ES81	C2DP7450	NLED17.3WXGA+G	N10MGS	512M-DDR3 (64*16*4)	SO2GBIi6	N500GB5.4KS	NSM8XS	5 in 1-Build in	SP1x2MMW	N	PM45	ICH9M	6CELL2.2	65W	0.3M DV
AS7736G-744G50Mn	EMEA	Middle East	LX.PHU02.005	AS7736G-744G50Mn EM W7HP64EMATME4 MC N10MGS512Cbk_V3 2*2G/500_L/ 6L2.2/5R/CB_n2_0.3D_HG_RU61	C2DP7450	NLED17.3WXGA+G	N10MGS	512M-DDR3 (64*16*4)	SO2GBIi6	N500GB5.4KS	NSM8XS	5 in 1-Build in	SP1x2MMW	N	PM45	ICH9M	6CELL2.2	65W	0.3M DV
AS7736G-744G50Mn	EMEA	South Africa	LX.PHU02.008	AS7736G-744G50Mn EM W7HP64EMATZA4 MC N10MGS512Cbk_V3 2*2G/500_L/ 6L2.2/5R/CB_n2_0.3D_HG_ES81	C2DP7450	NLED17.3WXGA+G	N10MGS	512M-DDR3 (64*16*4)	SO2GBIi6	N500GB5.4KS	NSM8XS	5 in 1-Build in	SP1x2MMW	N	PM45	ICH9M	6CELL2.2	65W	0.3M DV
AS7736G-744G50Mn	EMEA	Middle East	LX.PHU02.006	AS7736G-744G50Mn EM W7HP64EMATME3 MC N10MGS512Cbk_V3 2*2G/500_L/ 6L2.2/5R/CB_n2_0.3D_HG_ES81	C2DP7450	NLED17.3WXGA+G	N10MGS	512M-DDR3 (64*16*4)	SO2GBIi6	N500GB5.4KS	NSM8XS	5 in 1-Build in	SP1x2MMW	N	PM45	ICH9M	6CELL2.2	65W	0.3M DV
AS7736G-744G50Mn	EMEA	Middle East	LX.PHU02.012	AS7736G-744G50Mn EM W7HP64EMATME9 MC N10MGS512Cbk_V3 2*2G/500_L/ 6L2.2/5R/CB_n2_0.3D_HG_ES81	C2DP7450	NLED17.3WXGA+G	N10MGS	512M-DDR3 (64*16*4)	SO2GBIi6	N500GB5.4KS	NSM8XS	5 in 1-Build in	SP1x2MMW	N	PM45	ICH9M	6CELL2.2	65W	0.3M DV
AS7736G-744G50Mn	EMEA	Turkey	LX.PHU02.010	AS7736G-744G50Mn EM W7HP64EMATTR1 MC N10MGS512Cbk_V3 2*2G/500_L/ 6L2.2/5R/CB_n2_0.3D_HG_TR31	C2DP7450	NLED17.3WXGA+G	N10MGS	512M-DDR3 (64*16*4)	SO2GBIi6	N500GB5.4KS	NSM8XS	5 in 1-Build in	SP1x2MMW	N	PM45	ICH9M	6CELL2.2	65W	0.3M DV
AS7736G-744G50Mn	EMEA	South Africa	LX.PHU02.011	AS7736G-744G50Mn EM W7HP64EMATZA2 MC N10MGS512Cbk_V3 2*2G/500_L/ 6L2.2/5R/CB_n2_0.3D_HG_ES81	C2DP7450	NLED17.3WXGA+G	N10MGS	512M-DDR3 (64*16*4)	SO2GBIi6	N500GB5.4KS	NSM8XS	5 in 1-Build in	SP1x2MMW	N	PM45	ICH9M	6CELL2.2	65W	0.3M DV
AS7736G-744G50Mn	EMEA	Eastern Europe	LX.PHU02.019	AS7736G-744G50Mn W7HP64ATEU7 MC N10MGS512Cbk_V3 2*2G/500_L/ 6L2.2/5R/CB_n2_0.3D_HG_SL11	C2DP7450	NLED17.3WXGA+G	N10MGS	512M-DDR3 (64*16*4)	SO2GBIi6	N500GB5.4KS	NSM8XS	5 in 1-Build in	SP1x2MMW	N	PM45	ICH9M	6CELL2.2	65W	0.3M DV
AS7736G-744G50Mn	EMEA	Middle East	LX.PHU02.013	AS7736G-744G50Mn EM W7HP64EMATME6 MC N10MGS512Cbk_V3 2*2G/500_L/ 6L2.2/5R/CB_n2_0.3D_HG_ES81	C2DP7450	NLED17.3WXGA+G	N10MGS	512M-DDR3 (64*16*4)	SO2GBIi6	N500GB5.4KS	NSM8XS	5 in 1-Build in	SP1x2MMW	N	PM45	ICH9M	6CELL2.2	65W	0.3M DV
AS7736G-744G50Mn	EMEA	Middle East	LX.PHU02.014	AS7736G-744G50Mn EM W7HP64EMATME2 MC N10MGS512Cbk_V3 2*2G/500_L/ 6L2.2/5R/CB_n2_0.3D_HG_AR11	C2DP7450	NLED17.3WXGA+G	N10MGS	512M-DDR3 (64*16*4)	SO2GBIi6	N500GB5.4KS	NSM8XS	5 in 1-Build in	SP1x2MMW	N	PM45	ICH9M	6CELL2.2	65W	0.3M DV
AS7736G-744G50Mn	EMEA	Middle East	LX.PHU02.015	AS7736G-744G50Mn EM W7HP64EMATME4 MC N10MGS512Cbk_V3 2*2G/500_L/ 6L2.2/5R/CB_n2_0.3D_HG_ES81	C2DP7450	NLED17.3WXGA+G	N10MGS	512M-DDR3 (64*16*4)	SO2GBIi6	N500GB5.4KS	NSM8XS	5 in 1-Build in	SP1x2MMW	N	PM45	ICH9M	6CELL2.2	65W	0.3M DV

AS7736G-744G50Mn	EMEA	Sweden	LX.PHU02.033	AS7736G-744G50Mn W7HP64ATSE1 MC N10MGS512Cbk_V3 2*2G/500_L/ 6L2.2/5R/CB_n2_0.3D_HG_FH11	C2DP7450	NLED17.3WXGA+G	N10MGS	512M-DDR3 (64*16*4)	SO2GBI6	N500GB5.4KS	NSM8XS	5 in 1-Build in	SP1x2MMW	N	PM45	ICH9M	6CELL2.2	65W	0.3M DV
AS7736G-744G50Mn	EMEA	Luxembourg	LX.PHU02.039	AS7736G-744G50Mn W7HP64ATLU3 MC N10MGS512Cbk_V3 2*2G/500_L/ 6L2.2/5R/CB_n2_0.3D_HG_IT41	C2DP7450	NLED17.3WXGA+G	N10MGS	512M-DDR3 (64*16*4)	SO2GBI6	N500GB5.4KS	NSM8XS	5 in 1-Build in	SP1x2MMW	N	PM45	ICH9M	6CELL2.2	65W	0.3M DV
AS7736G-744G50Mn	EMEA	Cyprus	LX.PHU02.038	AS7736G-744G50Mn W7HP64ATCY1 MC N10MGS512Cbk_V3 2*2G/500_L/ 6L2.2/5R/CB_n2_0.3D_HG_ES61	C2DP7450	NLED17.3WXGA+G	N10MGS	512M-DDR3 (64*16*4)	SO2GBI6	N500GB5.4KS	NSM8XS	5 in 1-Build in	SP1x2MMW	N	PM45	ICH9M	6CELL2.2	65W	0.3M DV
AS7736G-744G50Mn	EMEA	Eastern Europe	LX.PHU02.020	AS7736G-744G50Mn W7HP64ATEU7 MC N10MGS512Cbk_V3 2*2G/500_L/ 6L2.2/5R/CB_n2_0.3D_HG_ENQ1	C2DP7450	NLED17.3WXGA+G	N10MGS	512M-DDR3 (64*16*4)	SO2GBI6	N500GB5.4KS	NSM8XS	5 in 1-Build in	SP1x2MMW	N	PM45	ICH9M	6CELL2.2	65W	0.3M DV
AS7736G-744G50Mn	EMEA	Italy	LX.PHU02.037	AS7736G-744G50Mn W7HP64ATTI1 MC N10MGS512Cbk_V3 2*2G/500_L/ 6L2.2/5R/CB_n2_0.3D_HG_IT11	C2DP7450	NLED17.3WXGA+G	N10MGS	512M-DDR3 (64*16*4)	SO2GBI6	N500GB5.4KS	NSM8XS	5 in 1-Build in	SP1x2MMW	N	PM45	ICH9M	6CELL2.2	65W	0.3M DV
AS7736G-744G50Mn	EMEA	Finland	LX.PHU02.036	AS7736G-744G50Mn W7HP64ATFI2 MC N10MGS512Cbk_V3 2*2G/500_L/ 6L2.2/5R/CB_n2_0.3D_HG_FH11	C2DP7450	NLED17.3WXGA+G	N10MGS	512M-DDR3 (64*16*4)	SO2GBI6	N500GB5.4KS	NSM8XS	5 in 1-Build in	SP1x2MMW	N	PM45	ICH9M	6CELL2.2	65W	0.3M DV
AS7736G-744G50Mn	EMEA	Norway	LX.PHU02.041	AS7736G-744G50Mn W7HP64ATNO1 MC N10MGS512Cbk_V3 2*2G/500_L/ 6L2.2/5R/CB_n2_0.3D_HG_NO11	C2DP7450	NLED17.3WXGA+G	N10MGS	512M-DDR3 (64*16*4)	SO2GBI6	N500GB5.4KS	NSM8XS	5 in 1-Build in	SP1x2MMW	N	PM45	ICH9M	6CELL2.2	65W	0.3M DV
AS7736G-744G50Mn	EMEA	UK	LX.PHU02.044	AS7736G-744G50Mn W7HP64ATGB1 MC N10MGS512Cbk_V3 2*2G/500_L/ 6L2.2/5R/CB_n2_0.3D_HG_EN11	C2DP7450	NLED17.3WXGA+G	N10MGS	512M-DDR3 (64*16*4)	SO2GBI6	N500GB5.4KS	NSM8XS	5 in 1-Build in	SP1x2MMW	N	PM45	ICH9M	6CELL2.2	65W	0.3M DV
AS7736G-744G50Mn	EMEA	Eastern Europe	LX.PHU02.042	AS7736G-744G50Mn W7HP64ATEU4 MC N10MGS512Cbk_V3 2*2G/500_L/ 6L2.2/5R/CB_n2_0.3D_HG_SV21	C2DP7450	NLED17.3WXGA+G	N10MGS	512M-DDR3 (64*16*4)	SO2GBI6	N500GB5.4KS	NSM8XS	5 in 1-Build in	SP1x2MMW	N	PM45	ICH9M	6CELL2.2	65W	0.3M DV
AS7736G-744G50Mn	EMEA	Austria	LX.PHU02.045	AS7736G-744G50Mn W7HP64ATAT1 MC N10MGS512Cbk_V3 2*2G/500_L/ 6L2.2/5R/CB_n2_0.3D_HG_DE61	C2DP7450	NLED17.3WXGA+G	N10MGS	512M-DDR3 (64*16*4)	SO2GBI6	N500GB5.4KS	NSM8XS	5 in 1-Build in	SP1x2MMW	N	PM45	ICH9M	6CELL2.2	65W	0.3M DV
AS7736G-744G50Mn	EMEA	Czech	LX.PHU02.040	AS7736G-744G50Mn W7HP64ATCZ2 MC N10MGS512Cbk_V3 2*2G/500_L/ 6L2.2/5R/CB_n2_0.3D_HG_SK11	C2DP7450	NLED17.3WXGA+G	N10MGS	512M-DDR3 (64*16*4)	SO2GBI6	N500GB5.4KS	NSM8XS	5 in 1-Build in	SP1x2MMW	N	PM45	ICH9M	6CELL2.2	65W	0.3M DV
AS7736G-744G50Mn	EMEA	France	LX.PHU02.043	AS7736G-744G50Mn W7HP64ATFR1 MC N10MGS512Cbk_V3 2*2G/500_L/ 6L2.2/5R/CB_n2_0.3D_HG_FR21	C2DP7450	NLED17.3WXGA+G	N10MGS	512M-DDR3 (64*16*4)	SO2GBI6	N500GB5.4KS	NSM8XS	5 in 1-Build in	SP1x2MMW	N	PM45	ICH9M	6CELL2.2	65W	0.3M DV
AS7736ZG-434G32Mn	EMEA	France	LX.PJA02.132	AS7736ZG-434G32Mn W7HP64ATFR1 MC N10MGS512Cbk_V3 2*2G/320/6L2.2/5R/CB_bgn_0.3D_HG_FR21	PMDT4300	NLED17.3WXGA+G	N10MGS	512M-DDR3 (64*16*4)	SO2GBI6	N320GB5.4KS	NSM8XS	5 in 1-Build in	3rd WiFi 1x2 BGN	N	GM45	ICH9M	6CELL2.2	65W	0.3M DV
AS7736ZG-433G32Mn	EMEA	Germany	LX.PJA02.134	AS7736ZG-433G32Mn W7HP64ATDE1 MC N10MGS512Cbk_V3 2G+1G/320/6L2.2/5R/CB_bgn_0.3D_HG_DE11	PMDT4300	NLED17.3WXGA+G	N10MGS	512M-DDR3 (64*16*4)	SO2GBI6/ SO1GBI6	N320GB5.4KS	NSM8XS	5 in 1-Build in	3rd WiFi 1x2 BGN	N	GM45	ICH9M	6CELL2.2	65W	0.3M DV
AS7736ZG-434G50Mn	EMEA	France	LX.PJA02.043	AS7736ZG-434G50Mn W7HP64ATFR1 MC N10MGS512Cbk_V3 2*2G/500_L/ 6L2.2/5R/CB_bgn_0.3D_HG_FR21	PMDT4300	NLED17.3WXGA+G	N10MGS	512M-DDR3 (64*16*4)	SO2GBI6	N500GB5.4KS	NSM8XS	5 in 1-Build in	3rd WiFi 1x2 BGN	N	GM45	ICH9M	6CELL2.2	65W	0.3M DV
AS7736ZG-434G25Mn	EMEA	France	LX.PJA02.139	AS7736ZG-434G25Mn W7HP64ATFR1 MC N10MGS512Cbk_V3 2*2G/250/6L2.2/5R/CB_bgn_0.3D_HG_FR21	PMDT4300	NLED17.3WXGA+G	N10MGS	512M-DDR3 (64*16*4)	SO2GBI6	N250GB5.4KS	NSM8XS	5 in 1-Build in	3rd WiFi 1x2 BGN	N	GM45	ICH9M	6CELL2.2	65W	0.3M DV
AS7736ZG-434G50Mn	EMEA	Sweden	LX.PJA02.033	AS7736ZG-434G50Mn W7HP64ATSE1 MC N10MGS512Cbk_V3 2*2G/500_L/ 6L2.2/5R/CB_bgn_0.3D_HG_FH11	PMDT4300	NLED17.3WXGA+G	N10MGS	512M-DDR3 (64*16*4)	SO2GBI6	N500GB5.4KS	NSM8XS	5 in 1-Build in	3rd WiFi 1x2 BGN	N	GM45	ICH9M	6CELL2.2	65W	0.3M DV
AS7736ZG-433G50Mn	EMEA	Latvia	LX.PJA0C.004	AS7736ZG-433G50Mn L1NPUSALV1 N10MGS512Cbk_V3 2G+1G/500_L/ BT/6L2.2/5R/CB_bgn_0.3D_HG_EN71	PMDT4300	NLED17.3WXGA+G	N10MGS	512M-DDR3 (64*16*4)	SO2GBI6/ SO1GBI6	N500GB5.4KS	NSM8XS	5 in 1-Build in	3rd WiFi 1x2 BGN	BT 2.1/N	GM45	ICH9M	6CELL2.2	65W	0.3M DV
AS7736ZG-434G50Mn	EMEA	Eastern Europe	LX.PJA0C.007	AS7736ZG-434G50Mn L1NPUSAEU7 N10MGS512Cbk_V3 2*2G/500_L/BT/ 6L2.2/5R/CB_bgn_0.3D_HG_EN11	PMDT4300	NLED17.3WXGA+G	N10MGS	512M-DDR3 (64*16*4)	SO2GBI6	N500GB5.4KS	NSM8XS	5 in 1-Build in	3rd WiFi 1x2 BGN	BT 2.1/N	GM45	ICH9M	6CELL2.2	65W	0.3M DV

AS7736ZG-434G50Mn	EMEA	Eastern Europe	LX.PJA02.136	AS7736ZG-434G50Mn W7HP64ATEU7 MC N10MGS512Cbk_V3 2*2G/500_L/BT/ 6L2.2/5R/CB_bgn_0.3D_HG_SL11	PMDT4300	NLED17.3WXGA+G	N10MGS	512M-DDR3 (64*16*4)	SO2GBI16	N500GB5.4KS	NSM8XS	5 in 1- Build in	3rd WiFi 1x2 BGN	BT 2.1/N	GM45	ICH9M	6CELL2.2	65W	0.3M DV
AS7736ZG-434G32Mn	EMEA	Germany	LX.PJA02.138	AS7736ZG-434G32Mn W7HP64ATDE1 MC N10MGS512Cbk_V3 2*2G/320/6L2.2/ 5R/CB_bgn_0.3D_HG_DE11	PMDT4300	NLED17.3WXGA+G	N10MGS	512M-DDR3 (64*16*4)	SO2GBI16	N320GB5.4KS	NSM8XS	5 in 1- Build in	3rd WiFi 1x2 BGN	N	GM45	ICH9M	6CELL2.2	65W	0.3M DV
AS7736ZG-434G32Mn	EMEA	Eastern Europe	LX.PJA0C.006	AS7736ZG-434G32Mn LIMPUSAEU5 N10MGS512Cbk_V3 2*2G/320/BT/ 6L2.2/5R/CB_bgn_0.3D_HG_ENF1	PMDT4300	NLED17.3WXGA+G	N10MGS	512M-DDR3 (64*16*4)	SO2GBI16	N320GB5.4KS	NSM8XS	5 in 1- Build in	3rd WiFi 1x2 BGN	BT 2.1/N	GM45	ICH9M	6CELL2.2	65W	0.3M DV
AS7736ZG-433G25Mn	EMEA	Middle East	LX.PJA02.096	AS7736ZG-433G25Mn EM W7HP64EMATME2 MC N10MGS512Cbk_V3 2G+1G/250/ 6L2.2/5R/CB_bgn_0.3D_HG_AR21	PMDT4300	NLED17.3WXGA+G	N10MGS	512M-DDR3 (64*16*4)	SO2GBI16/ SO1GBI16	N250GB5.4KS	NSM8XS	5 in 1- Build in	3rd WiFi 1x2 BGN	N	GM45	ICH9M	6CELL2.2	65W	0.3M DV
AS7736ZG-434G50Mn	EMEA	Middle East	LX.PJA02.055	AS7736ZG-434G50Mn EM W7HP64EMATME2 MC N10MGS512Cbk_V3 2*2G/500_L/ 6L2.2/5R/CB_bgn_0.3D_HG_AR21	PMDT4300	NLED17.3WXGA+G	N10MGS	512M-DDR3 (64*16*4)	SO2GBI16	N500GB5.4KS	NSM8XS	5 in 1- Build in	3rd WiFi 1x2 BGN	N	GM45	ICH9M	6CELL2.2	65W	0.3M DV
AS7736ZG-434G50Mn	EMEA	Middle East	LX.PJA02.008	AS7736ZG-434G50Mn EM W7HP64EMATME2 MC N10MGS512Cbk_V3 2*2G/500_L/ 6L2.2/5R/CB_bgn_0.3D_HG_AR21	PMDT4300	NLED17.3WXGA+G	N10MGS	512M-DDR3 (64*16*4)	SO2GBI16	N500GB5.4KS	NSM8XS	5 in 1- Build in	3rd WiFi 1x2 BGN	N	GM45	ICH9M	6CELL2.2	65W	0.3M DV
AS7736ZG-434G50Mn	EMEA	Eastern Europe	LX.PJA02.137	AS7736ZG-434G50Mn W7HP64ATEU7 MC N10MGS512Cbk_V3 2*2G/500_L/BT/ 6L2.2/5R/CB_bgn_0.3D_HG_ENQ1	PMDT4300	NLED17.3WXGA+G	N10MGS	512M-DDR3 (64*16*4)	SO2GBI16	N500GB5.4KS	NSM8XS	5 in 1- Build in	3rd WiFi 1x2 BGN	BT 2.1/N	GM45	ICH9M	6CELL2.2	65W	0.3M DV
AS7736ZG-433G50Mn	EMEA	Eastern Europe	LX.PJA0C.005	AS7736ZG-433G50Mn LIMPUSAEU5 N10MGS512Cbk_V3 2*2G/500_L/ BT/6L2.2/5R/ CB_bgn_0.3D_HG_ENF1	PMDT4300	NLED17.3WXGA+G	N10MGS	512M-DDR3 (64*16*4)	SO2GBI16/ SO1GBI16	N500GB5.4KS	NSM8XS	5 in 1- Build in	3rd WiFi 1x2 BGN	BT 2.1/N	GM45	ICH9M	6CELL2.2	65W	0.3M DV
AS7736ZG-434G32Mn	EMEA	Eastern Europe	LX.PJA02.133	AS7736ZG-434G32Mn W7HP64ATEU5 MC N10MGS512Cbk_V3 2*2G/320/BT/ 6L2.2/5R/CB_bgn_0.3D_HG_RO11	PMDT4300	NLED17.3WXGA+G	N10MGS	512M-DDR3 (64*16*4)	SO2GBI16	N320GB5.4KS	NSM8XS	5 in 1- Build in	3rd WiFi 1x2 BGN	BT 2.1/N	GM45	ICH9M	6CELL2.2	65W	0.3M DV
AS7736ZG-434G50Mn	EMEA	Poland	LX.PJA02.064	AS7736ZG-434G50Mn W7HP64ATPL1 MC N10MGS512Cbk_V3 2*2G/500_L/ 6L2.2/5R/CB_bgn_0.3D_HG_PL11	PMDT4300	NLED17.3WXGA+G	N10MGS	512M-DDR3 (64*16*4)	SO2GBI16	N500GB5.4KS	NSM8XS	5 in 1- Build in	3rd WiFi 1x2 BGN	N	GM45	ICH9M	6CELL2.2	65W	0.3M DV
AS7736ZG-434G50Mn	EMEA	Denmark	LX.PJA02.062	AS7736ZG-434G50Mn W7HP64ATDK1 MC N10MGS512Cbk_V3 2*2G/500_L/ 6L2.2/5R/CB_bgn_0.3D_HGO11	PMDT4300	NLED17.3WXGA+G	N10MGS	512M-DDR3 (64*16*4)	SO2GBI16	N500GB5.4KS	NSM8XS	5 in 1- Build in	3rd WiFi 1x2 BGN	N	GM45	ICH9M	6CELL2.2	65W	0.3M DV
AS7736ZG-434G50Mn	EMEA	Eastern Europe	LX.PJA02.063	AS7736ZG-434G50Mn W7HP64ATEU5 MC N10MGS512Cbk_V3 2*2G/500_L/ 6L2.2/5R/CB_bgn_0.3D_HG_RO11	PMDT4300	NLED17.3WXGA+G	N10MGS	512M-DDR3 (64*16*4)	SO2GBI16	N500GB5.4KS	NSM8XS	5 in 1- Build in	3rd WiFi 1x2 BGN	N	GM45	ICH9M	6CELL2.2	65W	0.3M DV
AS7736ZG-434G50Mn	EMEA	Greece	LX.PJA02.066	AS7736ZG-434G50Mn W7HP64ATGR1 MC N10MGS512Cbk_V3 2*2G/500_L/ 6L2.2/5R/CB_bgn_0.3D_HG_EL31	PMDT4300	NLED17.3WXGA+G	N10MGS	512M-DDR3 (64*16*4)	SO2GBI16	N500GB5.4KS	NSM8XS	5 in 1- Build in	3rd WiFi 1x2 BGN	N	GM45	ICH9M	6CELL2.2	65W	0.3M DV
AS7736ZG-434G50Mn	EMEA	Belgium	LX.PJA02.065	AS7736ZG-434G50Mn W7HP64ATBE1 MC N10MGS512Cbk_V3 2*2G/500_L/ 6L2.2/5R/CB_bgn_0.3D_HGL11	PMDT4300	NLED17.3WXGA+G	N10MGS	512M-DDR3 (64*16*4)	SO2GBI16	N500GB5.4KS	NSM8XS	5 in 1- Build in	3rd WiFi 1x2 BGN	N	GM45	ICH9M	6CELL2.2	65W	0.3M DV
AS7736ZG-434G50Mn	EMEA	Switzerland	LX.PJA02.068	AS7736ZG-434G50Mn W7HP64ATCH1 MC N10MGS512Cbk_V3 2*2G/500_L/ 6L2.2/5R/CB_bgn_0.3D_HG_IT41	PMDT4300	NLED17.3WXGA+G	N10MGS	512M-DDR3 (64*16*4)	SO2GBI16	N500GB5.4KS	NSM8XS	5 in 1- Build in	3rd WiFi 1x2 BGN	N	GM45	ICH9M	6CELL2.2	65W	0.3M DV
AS7736ZG-434G50Mn	EMEA	Eastern Europe	LX.PJA02.069	AS7736ZG-434G50Mn W7HP64ATEU5 MC N10MGS512Cbk_V3 2*2G/500_L/ 6L2.2/5R/CB_bgn_0.3D_HG_PL71	PMDT4300	NLED17.3WXGA+G	N10MGS	512M-DDR3 (64*16*4)	SO2GBI16	N500GB5.4KS	NSM8XS	5 in 1- Build in	3rd WiFi 1x2 BGN	N	GM45	ICH9M	6CELL2.2	65W	0.3M DV
AS7736ZG-434G50Mn	EMEA	Holland	LX.PJA02.067	AS7736ZG-434G50Mn W7HP64ATNL1 MC N10MGS512Cbk_V3 2*2G/500_L/ 6L2.2/5R/CB_bgn_0.3D_HGL11	PMDT4300	NLED17.3WXGA+G	N10MGS	512M-DDR3 (64*16*4)	SO2GBI16	N500GB5.4KS	NSM8XS	5 in 1- Build in	3rd WiFi 1x2 BGN	N	GM45	ICH9M	6CELL2.2	65W	0.3M DV

AS7736ZG-433G25MI	EMEA	Russia	LX.PJA02.089	AS7736ZG-433G25MI W7HP64RUATRU1 MC N10MGS512Cbk_V3 2G+1G/250/ 6L2.2/5R/CB_bgn_0.3D_HG_RU11	PMDT4300	NLED17.3WXGA+G	N10MGS	512M-DDR3 (64*16*4)	SO2GBI6/ SO1GBI6	N250GB5.4KS	NSM8XS	5 in 1- Build in	3rd WiFi BG	N	GM45	ICH9M	6CELL2.2	65W	0.3M DV
AS7736ZG-433G25Mn	EMEA	Ukraine	LX.PJA02.090	AS7736ZG-433G25Mn W7HP64RUATUK1 MC N10MGS512Cbk_V3 2G+1G/250/ 6L2.2/5R/CB_bgn_0.3D_HG_RU61	PMDT4300	NLED17.3WXGA+G	N10MGS	512M-DDR3 (64*16*4)	SO2GBI6/ SO1GBI6	N250GB5.4KS	NSM8XS	5 in 1- Build in	3rd WiFi 1x2 BGN	N	GM45	ICH9M	6CELL2.2	65W	0.3M DV
AS7736ZG-433G25Mn	EMEA	Middle East	LX.PJA02.094	AS7736ZG-433G25Mn EM W7HP64EMATME2 MC N10MGS512Cbk_V3 2G+1G/250/ 6L2.2/5R/CB_bgn_0.3D_HG_ES61	PMDT4300	NLED17.3WXGA+G	N10MGS	512M-DDR3 (64*16*4)	SO2GBI6/ SO1GBI6	N250GB5.4KS	NSM8XS	5 in 1- Build in	3rd WiFi 1x2 BGN	N	GM45	ICH9M	6CELL2.2	65W	0.3M DV
AS7736ZG-433G25Mn	EMEA	Algeria	LX.PJA02.091	AS7736ZG-433G25Mn EM W7HP64EMATDZ1 MC N10MGS512Cbk_V3 2G+1G/250/ 6L2.2/5R/CB_bgn_0.3D_HG_ES81	PMDT4300	NLED17.3WXGA+G	N10MGS	512M-DDR3 (64*16*4)	SO2GBI6/ SO1GBI6	N250GB5.4KS	NSM8XS	5 in 1- Build in	3rd WiFi 1x2 BGN	N	GM45	ICH9M	6CELL2.2	65W	0.3M DV
AS7736ZG-433G25Mn	EMEA	South Africa	LX.PJA02.092	AS7736ZG-433G25Mn EM W7HP64EMATZA1 MC N10MGS512Cbk_V3 2G+1G/250/ 6L2.2/5R/CB_bgn_0.3D_HG_ES81	PMDT4300	NLED17.3WXGA+G	N10MGS	512M-DDR3 (64*16*4)	SO2GBI6/ SO1GBI6	N250GB5.4KS	NSM8XS	5 in 1- Build in	3rd WiFi 1x2 BGN	N	GM45	ICH9M	6CELL2.2	65W	0.3M DV
AS7736ZG-433G25Mn	EMEA	Middle East	LX.PJA02.093	AS7736ZG-433G25Mn EM W7HP64EMATM4 MC N10MGS512Cbk_V3 2G+1G/250/ 6L2.2/5R/CB_bgn_0.3D_HG_RU61	PMDT4300	NLED17.3WXGA+G	N10MGS	512M-DDR3 (64*16*4)	SO2GBI6/ SO1GBI6	N250GB5.4KS	NSM8XS	5 in 1- Build in	3rd WiFi 1x2 BGN	N	GM45	ICH9M	6CELL2.2	65W	0.3M DV
AS7736ZG-433G25Mn	EMEA	South Africa	LX.PJA02.095	AS7736ZG-433G25Mn EM W7HP64EMATZA4 MC N10MGS512Cbk_V3 2G+1G/250/ 6L2.2/5R/CB_bgn_0.3D_HG_ES61	PMDT4300	NLED17.3WXGA+G	N10MGS	512M-DDR3 (64*16*4)	SO2GBI6/ SO1GBI6	N250GB5.4KS	NSM8XS	5 in 1- Build in	3rd WiFi 1x2 BGN	N	GM45	ICH9M	6CELL2.2	65W	0.3M DV
AS7736ZG-433G25Mn	EMEA	Middle East	LX.PJA02.097	AS7736ZG-433G25Mn EM W7HP64EMATM3 MC N10MGS512Cbk_V3 2G+1G/250/ 6L2.2/5R/CB_bgn_0.3D_HG_ES81	PMDT4300	NLED17.3WXGA+G	N10MGS	512M-DDR3 (64*16*4)	SO2GBI6/ SO1GBI6	N250GB5.4KS	NSM8XS	5 in 1- Build in	3rd WiFi 1x2 BGN	N	GM45	ICH9M	6CELL2.2	65W	0.3M DV
AS7736ZG-433G25Mn	EMEA	Middle East	LX.PJA02.101	AS7736ZG-433G25Mn EM W7HP64EMATM9 MC N10MGS512Cbk_V3 2G+1G/250/ 6L2.2/5R/CB_bgn_0.3D_HG_ES81	PMDT4300	NLED17.3WXGA+G	N10MGS	512M-DDR3 (64*16*4)	SO2GBI6/ SO1GBI6	N250GB5.4KS	NSM8XS	5 in 1- Build in	3rd WiFi 1x2 BGN	N	GM45	ICH9M	6CELL2.2	65W	0.3M DV
AS7736ZG-433G25Mn	EMEA	Middle East	LX.PJA02.102	AS7736ZG-433G25Mn EM W7HP64EMATM4 MC N10MGS512Cbk_V3 2G+1G/250/ 6L2.2/5R/CB_bgn_0.3D_HG_ES61	PMDT4300	NLED17.3WXGA+G	N10MGS	512M-DDR3 (64*16*4)	SO2GBI6/ SO1GBI6	N250GB5.4KS	NSM8XS	5 in 1- Build in	3rd WiFi 1x2 BGN	N	GM45	ICH9M	6CELL2.2	65W	0.3M DV
AS7736ZG-433G25Mn	EMEA	Turkey	LX.PJA02.098	AS7736ZG-433G25Mn EM W7HP64EMATTR1 MC N10MGS512Cbk_V3 2G+1G/250/ 6L2.2/5R/CB_bgn_0.3D_HG_TR31	PMDT4300	NLED17.3WXGA+G	N10MGS	512M-DDR3 (64*16*4)	SO2GBI6/ SO1GBI6	N250GB5.4KS	NSM8XS	5 in 1- Build in	3rd WiFi 1x2 BGN	N	GM45	ICH9M	6CELL2.2	65W	0.3M DV
AS7736ZG-433G25Mn	EMEA	South Africa	LX.PJA02.099	AS7736ZG-433G25Mn EM W7HP64EMATZA2 MC N10MGS512Cbk_V3 2G+1G/250/ 6L2.2/5R/CB_bgn_0.3D_HG_ES61	PMDT4300	NLED17.3WXGA+G	N10MGS	512M-DDR3 (64*16*4)	SO2GBI6/ SO1GBI6	N250GB5.4KS	NSM8XS	5 in 1- Build in	3rd WiFi 1x2 BGN	N	GM45	ICH9M	6CELL2.2	65W	0.3M DV
AS7736ZG-433G25Mn	EMEA	Middle East	LX.PJA02.103	AS7736ZG-433G25Mn EM W7HP64EMATME2 MC N10MGS512Cbk_V3 2G+1G/250/ 6L2.2/5R/CB_bgn_0.3D_HG_AR11	PMDT4300	NLED17.3WXGA+G	N10MGS	512M-DDR3 (64*16*4)	SO2GBI6/ SO1GBI6	N250GB5.4KS	NSM8XS	5 in 1- Build in	3rd WiFi 1x2 BGN	N	GM45	ICH9M	6CELL2.2	65W	0.3M DV
AS7736ZG-433G25Mn	EMEA	Eastern Europe	LX.PJA02.105	AS7736ZG-433G25Mn W7HP64ATEU7 MC N10MGS512Cbk_V3 2G+1G/250/ 6L2.2/5R/CB_bgn_0.3D_HG_SL11	PMDT4300	NLED17.3WXGA+G	N10MGS	512M-DDR3 (64*16*4)	SO2GBI6/ SO1GBI6	N250GB5.4KS	NSM8XS	5 in 1- Build in	3rd WiFi 1x2 BGN	N	GM45	ICH9M	6CELL2.2	65W	0.3M DV
AS7736ZG-433G25Mn	EMEA	Middle East	LX.PJA02.104	AS7736ZG-433G25Mn EM W7HP64EMATME6 MC N10MGS512Cbk_V3 2G+1G/250/ 6L2.2/5R/CB_bgn_0.3D_HG_ES61	PMDT4300	NLED17.3WXGA+G	N10MGS	512M-DDR3 (64*16*4)	SO2GBI6/ SO1GBI6	N250GB5.4KS	NSM8XS	5 in 1- Build in	3rd WiFi 1x2 BGN	N	GM45	ICH9M	6CELL2.2	65W	0.3M DV
AS7736ZG-433G25Mn	EMEA	Eastern Europe	LX.PJA02.106	AS7736ZG-433G25Mn W7HP64ATEU7 MC N10MGS512Cbk_V3 2G+1G/250/ 6L2.2/5R/CB_bgn_0.3D_HG_ENQ1	PMDT4300	NLED17.3WXGA+G	N10MGS	512M-DDR3 (64*16*4)	SO2GBI6/ SO1GBI6	N250GB5.4KS	NSM8XS	5 in 1- Build in	3rd WiFi 1x2 BGN	N	GM45	ICH9M	6CELL2.2	65W	0.3M DV
AS7736ZG-433G25Mn	EMEA	Italy	LX.PJA02.110	AS7736ZG-433G25Mn W7HP64ATT1 MC N10MGS512Cbk_V3 2G+1G/250/ 6L2.2/5R/CB_bgn_0.3D_HG_IT11	PMDT4300	NLED17.3WXGA+G	N10MGS	512M-DDR3 (64*16*4)	SO2GBI6/ SO1GBI6	N250GB5.4KS	NSM8XS	5 in 1- Build in	3rd WiFi 1x2 BGN	N	GM45	ICH9M	6CELL2.2	65W	0.3M DV

AS7736ZG-433G25Mn	EMEA	Cyprus	LX.PJA02.109	AS7736ZG-433G25Mn W7HP64ATCY1 MC N10MGS512Cbk_V3 2G+1G/250/ 6L2.2/5R/CB_bgn_0.3D_HG_ES61	PMDT4300	NLED17.3WXGA+G	N10MGS	512M-DDR3 (64*16*4)	SO2GBI6/ SO1GBI6	N250GB5.4KS	NSM8XS	5 in 1- Build in	3rd WiFi 1x2 BGN	N	GM45	ICH9M	6CELL2.2	65W	0.3M DV
AS7736ZG-433G25Mn	EMEA	Luxembourg	LX.PJA02.108	AS7736ZG-433G25Mn W7HP64ATLJ3 MC N10MGS512Cbk_V3 2G+1G/250/ 6L2.2/5R/CB_bgn_0.3D_HG_IT41	PMDT4300	NLED17.3WXGA+G	N10MGS	512M-DDR3 (64*16*4)	SO2GBI6/ SO1GBI6	N250GB5.4KS	NSM8XS	5 in 1- Build in	3rd WiFi 1x2 BGN	N	GM45	ICH9M	6CELL2.2	65W	0.3M DV
AS7736ZG-433G25Mn	EMEA	Finland	LX.PJA02.111	AS7736ZG-433G25Mn W7HP64ATF12 MC N10MGS512Cbk_V3 2G+1G/250/ 6L2.2/5R/CB_bgn_0.3D_HG_FI11	PMDT4300	NLED17.3WXGA+G	N10MGS	512M-DDR3 (64*16*4)	SO2GBI6/ SO1GBI6	N250GB5.4KS	NSM8XS	5 in 1- Build in	3rd WiFi 1x2 BGN	N	GM45	ICH9M	6CELL2.2	65W	0.3M DV
AS7736ZG-433G25Mn	EMEA	Sweden	LX.PJA02.107	AS7736ZG-433G25Mn W7HP64ATSE1 MC N10MGS512Cbk_V3 2G+1G/250/ 6L2.2/5R/CB_bgn_0.3D_HG_FI11	PMDT4300	NLED17.3WXGA+G	N10MGS	512M-DDR3 (64*16*4)	SO2GBI6/ SO1GBI6	N250GB5.4KS	NSM8XS	5 in 1- Build in	3rd WiFi 1x2 BGN	N	GM45	ICH9M	6CELL2.2	65W	0.3M DV
AS7736ZG-433G25Mn	EMEA	Norway	LX.PJA02.113	AS7736ZG-433G25Mn W7HP64ATNO1 MC N10MGS512Cbk_V3 2G+1G/250/ 6L2.2/5R/CB_bgn_0.3D_HGO11	PMDT4300	NLED17.3WXGA+G	N10MGS	512M-DDR3 (64*16*4)	SO2GBI6/ SO1GBI6	N250GB5.4KS	NSM8XS	5 in 1- Build in	3rd WiFi 1x2 BGN	N	GM45	ICH9M	6CELL2.2	65W	0.3M DV
AS7736ZG-433G25Mn	EMEA	Eastern Europe	LX.PJA02.114	AS7736ZG-433G25Mn W7HP64ATEU4 MC N10MGS512Cbk_V3 2G+1G/250/ 6L2.2/5R/CB_bgn_0.3D_HG_SV21	PMDT4300	NLED17.3WXGA+G	N10MGS	512M-DDR3 (64*16*4)	SO2GBI6/ SO1GBI6	N250GB5.4KS	NSM8XS	5 in 1- Build in	3rd WiFi 1x2 BGN	N	GM45	ICH9M	6CELL2.2	65W	0.3M DV
AS7736ZG-433G25Mn	EMEA	Austria	LX.PJA02.115	AS7736ZG-433G25Mn W7HP64ATAT1 MC N10MGS512Cbk_V3 2G+1G/250/ 6L2.2/5R/CB_bgn_0.3D_HG_DE61	PMDT4300	NLED17.3WXGA+G	N10MGS	512M-DDR3 (64*16*4)	SO2GBI6/ SO1GBI6	N250GB5.4KS	NSM8XS	5 in 1- Build in	3rd WiFi 1x2 BGN	N	GM45	ICH9M	6CELL2.2	65W	0.3M DV
AS7736ZG-433G25Mn	EMEA	UK	LX.PJA02.116	AS7736ZG-433G25Mn W7HP64ATGB1 MC N10MGS512Cbk_V3 2G+1G/250/ 6L2.2/5R/CB_bgn_0.3D_HG_EN11	PMDT4300	NLED17.3WXGA+G	N10MGS	512M-DDR3 (64*16*4)	SO2GBI6/ SO1GBI6	N250GB5.4KS	NSM8XS	5 in 1- Build in	3rd WiFi 1x2 BGN	N	GM45	ICH9M	6CELL2.2	65W	0.3M DV
AS7736ZG-433G25Mn	EMEA	Czech	LX.PJA02.112	AS7736ZG-433G25Mn W7HP64ATCZ2 MC N10MGS512Cbk_V3 2G+1G/250/ 6L2.2/5R/CB_bgn_0.3D_HG_SK11	PMDT4300	NLED17.3WXGA+G	N10MGS	512M-DDR3 (64*16*4)	SO2GBI6/ SO1GBI6	N250GB5.4KS	NSM8XS	5 in 1- Build in	3rd WiFi 1x2 BGN	N	GM45	ICH9M	6CELL2.2	65W	0.3M DV
AS7736ZG-433G25Mn	EMEA	Norway	LX.PJA02.118	AS7736ZG-433G25Mn W7HP64ATNO3 MC N10MGS512Cbk_V3 2G+1G/250/ 6L2.2/5R/CB_bgn_0.3D_HG_ENS1	PMDT4300	NLED17.3WXGA+G	N10MGS	512M-DDR3 (64*16*4)	SO2GBI6/ SO1GBI6	N250GB5.4KS	NSM8XS	5 in 1- Build in	3rd WiFi 1x2 BGN	N	GM45	ICH9M	6CELL2.2	65W	0.3M DV
AS7736ZG-433G25Mn	EMEA	France	LX.PJA02.117	AS7736ZG-433G25Mn W7HP64ATFR1 MC N10MGS512Cbk_V3 2G+1G/250/ 6L2.2/5R/CB_bgn_0.3D_HG_FR21	PMDT4300	NLED17.3WXGA+G	N10MGS	512M-DDR3 (64*16*4)	SO2GBI6/ SO1GBI6	N250GB5.4KS	NSM8XS	5 in 1- Build in	3rd WiFi 1x2 BGN	N	GM45	ICH9M	6CELL2.2	65W	0.3M DV
AS7736ZG-433G25Mn	EMEA	Germany	LX.PJA02.119	AS7736ZG-433G25Mn W7HP64ATDE1 MC N10MGS512Cbk_V3 2G+1G/250/ 6L2.2/5R/CB_bgn_0.3D_HG_DE11	PMDT4300	NLED17.3WXGA+G	N10MGS	512M-DDR3 (64*16*4)	SO2GBI6/ SO1GBI6	N250GB5.4KS	NSM8XS	5 in 1- Build in	3rd WiFi 1x2 BGN	N	GM45	ICH9M	6CELL2.2	65W	0.3M DV
AS7736ZG-433G25Mn	EMEA	Denmark	LX.PJA02.124	AS7736ZG-433G25Mn W7HP64ATDK1 MC N10MGS512Cbk_V3 2G+1G/250/ 6L2.2/5R/CB_bgn_0.3D_HGO11	PMDT4300	NLED17.3WXGA+G	N10MGS	512M-DDR3 (64*16*4)	SO2GBI6/ SO1GBI6	N250GB5.4KS	NSM8XS	5 in 1- Build in	3rd WiFi 1x2 BGN	N	GM45	ICH9M	6CELL2.2	65W	0.3M DV
AS7736ZG-433G25Mn	EMEA	Spain	LX.PJA02.122	AS7736ZG-433G25Mn W7HP64ATES1 MC N10MGS512Cbk_V3 2G+1G/250/ 6L2.2/5R/CB_bgn_0.3D_HG_ES51	PMDT4300	NLED17.3WXGA+G	N10MGS	512M-DDR3 (64*16*4)	SO2GBI6/ SO1GBI6	N250GB5.4KS	NSM8XS	5 in 1- Build in	3rd WiFi 1x2 BGN	N	GM45	ICH9M	6CELL2.2	65W	0.3M DV
AS7736ZG-433G25Mn	EMEA	Portugal	LX.PJA02.120	AS7736ZG-433G25Mn W7HP64ATPT1 MC N10MGS512Cbk_V3 2G+1G/250/ 6L2.2/5R/CB_bgn_0.3D_HG_PT11	PMDT4300	NLED17.3WXGA+G	N10MGS	512M-DDR3 (64*16*4)	SO2GBI6/ SO1GBI6	N250GB5.4KS	NSM8XS	5 in 1- Build in	3rd WiFi 1x2 BGN	N	GM45	ICH9M	6CELL2.2	65W	0.3M DV
AS7736ZG-433G25Mn	EMEA	Denmark	LX.PJA02.121	AS7736ZG-433G25Mn W7HP64ATDK2 MC N10MGS512Cbk_V3 2G+1G/250/ 6L2.2/5R/CB_bgn_0.3D_HG_ENS1	PMDT4300	NLED17.3WXGA+G	N10MGS	512M-DDR3 (64*16*4)	SO2GBI6/ SO1GBI6	N250GB5.4KS	NSM8XS	5 in 1- Build in	3rd WiFi 1x2 BGN	N	GM45	ICH9M	6CELL2.2	65W	0.3M DV
AS7736ZG-433G25Mn	EMEA	Hungary	LX.PJA02.123	AS7736ZG-433G25Mn W7HP64ATHU1 MC N10MGS512Cbk_V3 2G+1G/250/ 6L2.2/5R/CB_bgn_0.3D_HG_HU11	PMDT4300	NLED17.3WXGA+G	N10MGS	512M-DDR3 (64*16*4)	SO2GBI6/ SO1GBI6	N250GB5.4KS	NSM8XS	5 in 1- Build in	3rd WiFi 1x2 BGN	N	GM45	ICH9M	6CELL2.2	65W	0.3M DV



AS7736ZG-433G25Mn	EMEA	Poland	LX.PJA02.126	AS7736ZG-433G25Mn W7HP64ATPL1 MC N10MGS512Cbk_V3 2G+1G/250/ 6L2.2/5R/CB_bgn_0.3D_HG_PL11	PMDT4300	NLED17.3WXGA+G	N10MGS	512M-DDR3 (64*16*4)	SO2GBI6/ SO1GBI6	N250GB5.4KS	NSM8XS	5 in 1- Build in	3rd WiFi 1x2 BGN	N	GM45	ICH9M	6CELL2.2	65W	0.3M DV
AS7736ZG-433G25Mn	EMEA	Eastern Europe	LX.PJA02.125	AS7736ZG-433G25Mn W7HP64ATEU5 MC N10MGS512Cbk_V3 2G+1G/250/ 6L2.2/5R/CB_bgn_0.3D_HG_RO11	PMDT4300	NLED17.3WXGA+G	N10MGS	512M-DDR3 (64*16*4)	SO2GBI6/ SO1GBI6	N250GB5.4KS	NSM8XS	5 in 1- Build in	3rd WiFi 1x2 BGN	N	GM45	ICH9M	6CELL2.2	65W	0.3M DV
AS7736ZG-433G25Mn	EMEA	Belgium	LX.PJA02.127	AS7736ZG-433G25Mn W7HP64ATBE1 MC N10MGS512Cbk_V3 2G+1G/250/ 6L2.2/5R/CB_bgn_0.3D_HGL11	PMDT4300	NLED17.3WXGA+G	N10MGS	512M-DDR3 (64*16*4)	SO2GBI6/ SO1GBI6	N250GB5.4KS	NSM8XS	5 in 1- Build in	3rd WiFi 1x2 BGN	N	GM45	ICH9M	6CELL2.2	65W	0.3M DV
AS7736ZG-433G25Mn	EMEA	Greece	LX.PJA02.128	AS7736ZG-433G25Mn W7HP64ATGR1 MC N10MGS512Cbk_V3 2G+1G/250/ 6L2.2/5R/CB_bgn_0.3D_HG_EL31	PMDT4300	NLED17.3WXGA+G	N10MGS	512M-DDR3 (64*16*4)	SO2GBI6/ SO1GBI6	N250GB5.4KS	NSM8XS	5 in 1- Build in	3rd WiFi 1x2 BGN	N	GM45	ICH9M	6CELL2.2	65W	0.3M DV
AS7736ZG-433G25Mn	EMEA	Holland	LX.PJA02.129	AS7736ZG-433G25Mn W7HP64ATNL1 MC N10MGS512Cbk_V3 2G+1G/250/ 6L2.2/5R/CB_bgn_0.3D_HGL11	PMDT4300	NLED17.3WXGA+G	N10MGS	512M-DDR3 (64*16*4)	SO2GBI6/ SO1GBI6	N250GB5.4KS	NSM8XS	5 in 1- Build in	3rd WiFi 1x2 BGN	N	GM45	ICH9M	6CELL2.2	65W	0.3M DV
AS7736ZG-433G25Mn	EMEA	Eastern Europe	LX.PJA02.131	AS7736ZG-433G25Mn W7HP64ATEU5 MC N10MGS512Cbk_V3 2G+1G/250/ 6L2.2/5R/CB_bgn_0.3D_HG_PL71	PMDT4300	NLED17.3WXGA+G	N10MGS	512M-DDR3 (64*16*4)	SO2GBI6/ SO1GBI6	N250GB5.4KS	NSM8XS	5 in 1- Build in	3rd WiFi 1x2 BGN	N	GM45	ICH9M	6CELL2.2	65W	0.3M DV
AS7736ZG-433G25Mn	EMEA	Switzerland	LX.PJA02.130	AS7736ZG-433G25Mn W7HP64ATCH1 MC N10MGS512Cbk_V3 2G+1G/250/ 6L2.2/5R/CB_bgn_0.3D_HG_IT41	PMDT4300	NLED17.3WXGA+G	N10MGS	512M-DDR3 (64*16*4)	SO2GBI6/ SO1GBI6	N250GB5.4KS	NSM8XS	5 in 1- Build in	3rd WiFi 1x2 BGN	N	GM45	ICH9M	6CELL2.2	65W	0.3M DV
AS7736ZG-434G50Mn	EMEA	Ukraine	LX.PJA02.048	AS7736ZG-434G50Mn W7HP64RUATUK1 MC N10MGS512Cbk_V3 2*2G/500_L/ 6L2.2/5R/CB_bgn_0.3D_HG_RU61	PMDT4300	NLED17.3WXGA+G	N10MGS	512M-DDR3 (64*16*4)	SO2GBI6	N500GB5.4KS	NSM8XS	5 in 1- Build in	3rd WiFi 1x2 BGN	N	GM45	ICH9M	6CELL2.2	65W	0.3M DV
AS7736ZG-434G50Mi	EMEA	Russia	LX.PJA02.047	AS7736ZG-434G50Mi W7HP64RUATRU1 MC N10MGS512Cbk_V3 2*2G/500_L/ 6L2.2/5R/CB_bgn_0.3D_HG_RU11	PMDT4300	NLED17.3WXGA+G	N10MGS	512M-DDR3 (64*16*4)	SO2GBI6	N500GB5.4KS	NSM8XS	5 in 1- Build in	3rd WiFi BG	N	GM45	ICH9M	6CELL2.2	65W	0.3M DV
AS7736ZG-434G50Mn	EMEA	South Africa	LX.PJA02.052	AS7736ZG-434G50Mn EM W7HP64EMATZA1 MC N10MGS512Cbk_V3 2*2G/500_L/ 6L2.2/5R/CB_bgn_0.3D_HG_ES81	PMDT4300	NLED17.3WXGA+G	N10MGS	512M-DDR3 (64*16*4)	SO2GBI6	N500GB5.4KS	NSM8XS	5 in 1- Build in	3rd WiFi 1x2 BGN	N	GM45	ICH9M	6CELL2.2	65W	0.3M DV
AS7736ZG-434G50Mn	EMEA	Algeria	LX.PJA02.049	AS7736ZG-434G50Mn EM W7HP64EMATDZ1 MC N10MGS512Cbk_V3 2*2G/500_L/ 6L2.2/5R/CB_bgn_0.3D_HG_ES81	PMDT4300	NLED17.3WXGA+G	N10MGS	512M-DDR3 (64*16*4)	SO2GBI6	N500GB5.4KS	NSM8XS	5 in 1- Build in	3rd WiFi 1x2 BGN	N	GM45	ICH9M	6CELL2.2	65W	0.3M DV
AS7736ZG-434G50Mn	EMEA	Middle East	LX.PJA02.050	AS7736ZG-434G50Mn EM W7HP64EMATME2 MC N10MGS512Cbk_V3 2*2G/500_L/ 6L2.2/5R/CB_bgn_0.3D_HG_ES61	PMDT4300	NLED17.3WXGA+G	N10MGS	512M-DDR3 (64*16*4)	SO2GBI6	N500GB5.4KS	NSM8XS	5 in 1- Build in	3rd WiFi 1x2 BGN	N	GM45	ICH9M	6CELL2.2	65W	0.3M DV
AS7736ZG-434G50Mn	EMEA	Middle East	LX.PJA02.054	AS7736ZG-434G50Mn EM W7HP64EMATME3 MC N10MGS512Cbk_V3 2*2G/500_L/ 6L2.2/5R/CB_bgn_0.3D_HG_ES81	PMDT4300	NLED17.3WXGA+G	N10MGS	512M-DDR3 (64*16*4)	SO2GBI6	N500GB5.4KS	NSM8XS	5 in 1- Build in	3rd WiFi 1x2 BGN	N	GM45	ICH9M	6CELL2.2	65W	0.3M DV
AS7736ZG-434G50Mn	EMEA	Middle East	LX.PJA02.051	AS7736ZG-434G50Mn EM W7HP64EMATME4 MC N10MGS512Cbk_V3 2*2G/500_L/ 6L2.2/5R/CB_bgn_0.3D_HG_RU61	PMDT4300	NLED17.3WXGA+G	N10MGS	512M-DDR3 (64*16*4)	SO2GBI6	N500GB5.4KS	NSM8XS	5 in 1- Build in	3rd WiFi 1x2 BGN	N	GM45	ICH9M	6CELL2.2	65W	0.3M DV
AS7736ZG-434G50Mn	EMEA	South Africa	LX.PJA02.056	AS7736ZG-434G50Mn EM W7HP64EMATZA4 MC N10MGS512Cbk_V3 2*2G/500_L/ 6L2.2/5R/CB_bgn_0.3D_HG_ES81	PMDT4300	NLED17.3WXGA+G	N10MGS	512M-DDR3 (64*16*4)	SO2GBI6	N500GB5.4KS	NSM8XS	5 in 1- Build in	3rd WiFi 1x2 BGN	N	GM45	ICH9M	6CELL2.2	65W	0.3M DV
AS7736ZG-434G50Mn	EMEA	Turkey	LX.PJA02.053	AS7736ZG-434G50Mn EM W7HP64EMATTR1 MC N10MGS512Cbk_V3 2*2G/500_L/ 6L2.2/5R/CB_bgn_0.3D_HG_TR31	PMDT4300	NLED17.3WXGA+G	N10MGS	512M-DDR3 (64*16*4)	SO2GBI6	N500GB5.4KS	NSM8XS	5 in 1- Build in	3rd WiFi 1x2 BGN	N	GM45	ICH9M	6CELL2.2	65W	0.3M DV

AS7736ZG-434G50Mn	EMEA	South Africa	LX.PJA02.057	AS7736ZG-434G50Mn EM W7HP64EMATZA2 MC N10MGS512Cbk_V3 2*2G/500_L/ 6L2.2/5R/CB_bgn_0.3D_HG_ES61	PMDT4300	NLED17.3WXGA+G	N10MGS	512M-DDR3 (64*16*4)	SO2GBIi6	N500GB5.4KS	NSM8XS	5 in 1- Build in	3rd WiFi 1x2 BGN	N	GM45	ICH9M	6CELL2.2	65W	0.3M DV
AS7736ZG-434G50Mn	EMEA	Eastern Europe	LX.PJA02.072	AS7736ZG-434G50Mn W7HP64ATEU7 MC N10MGS512Cbk_V3 2*2G/500_L/ 6L2.2/5R/CB_bgn_0.3D_HG_SL11	PMDT4300	NLED17.3WXGA+G	N10MGS	512M-DDR3 (64*16*4)	SO2GBIi6	N500GB5.4KS	NSM8XS	5 in 1- Build in	3rd WiFi 1x2 BGN	N	GM45	ICH9M	6CELL2.2	65W	0.3M DV
AS7736ZG-434G50Mn	EMEA	Middle East	LX.PJA02.058	AS7736ZG-434G50Mn EM W7HP64EMATME9 MC N10MGS512Cbk_V3 2*2G/500_L/ 6L2.2/5R/CB_bgn_0.3D_HG_ES81	PMDT4300	NLED17.3WXGA+G	N10MGS	512M-DDR3 (64*16*4)	SO2GBIi6	N500GB5.4KS	NSM8XS	5 in 1- Build in	3rd WiFi 1x2 BGN	N	GM45	ICH9M	6CELL2.2	65W	0.3M DV
AS7736ZG-434G50Mn	EMEA	Middle East	LX.PJA02.059	AS7736ZG-434G50Mn EM W7HP64EMATME4 MC N10MGS512Cbk_V3 2*2G/500_L/ 6L2.2/5R/CB_bgn_0.3D_HG_ES61	PMDT4300	NLED17.3WXGA+G	N10MGS	512M-DDR3 (64*16*4)	SO2GBIi6	N500GB5.4KS	NSM8XS	5 in 1- Build in	3rd WiFi 1x2 BGN	N	GM45	ICH9M	6CELL2.2	65W	0.3M DV
AS7736ZG-434G50Mn	EMEA	Middle East	LX.PJA02.060	AS7736ZG-434G50Mn EM W7HP64EMATME6 MC N10MGS512Cbk_V3 2*2G/500_L/ 6L2.2/5R/CB_bgn_0.3D_HG_ES61	PMDT4300	NLED17.3WXGA+G	N10MGS	512M-DDR3 (64*16*4)	SO2GBIi6	N500GB5.4KS	NSM8XS	5 in 1- Build in	3rd WiFi 1x2 BGN	N	GM45	ICH9M	6CELL2.2	65W	0.3M DV
AS7736ZG-434G50Mn	EMEA	Middle East	LX.PJA02.061	AS7736ZG-434G50Mn EM W7HP64EMATME2 MC N10MGS512Cbk_V3 2*2G/500_L/ 6L2.2/5R/CB_bgn_0.3D_HG_AR11	PMDT4300	NLED17.3WXGA+G	N10MGS	512M-DDR3 (64*16*4)	SO2GBIi6	N500GB5.4KS	NSM8XS	5 in 1- Build in	3rd WiFi 1x2 BGN	N	GM45	ICH9M	6CELL2.2	65W	0.3M DV
AS7736ZG-434G50Mn	EMEA	Eastern Europe	LX.PJA02.071	AS7736ZG-434G50Mn W7HP64ATEU7 MC N10MGS512Cbk_V3 2*2G/500_L/ 6L2.2/5R/CB_bgn_0.3D_HG_ENQ1	PMDT4300	NLED17.3WXGA+G	N10MGS	512M-DDR3 (64*16*4)	SO2GBIi6	N500GB5.4KS	NSM8XS	5 in 1- Build in	3rd WiFi 1x2 BGN	N	GM45	ICH9M	6CELL2.2	65W	0.3M DV
AS7736ZG-434G50Mn	EMEA	Sweden	LX.PJA02.070	AS7736ZG-434G50Mn W7HP64ATSE1 MC N10MGS512Cbk_V3 2*2G/500_L/ 6L2.2/5R/CB_bgn_0.3D_HG_F111	PMDT4300	NLED17.3WXGA+G	N10MGS	512M-DDR3 (64*16*4)	SO2GBIi6	N500GB5.4KS	NSM8XS	5 in 1- Build in	3rd WiFi 1x2 BGN	N	GM45	ICH9M	6CELL2.2	65W	0.3M DV
AS7736ZG-434G50Mn	EMEA	Italy	LX.PJA02.074	AS7736ZG-434G50Mn W7HP64ATT1 MC N10MGS512Cbk_V3 2*2G/500_L/ 6L2.2/5R/CB_bgn_0.3D_HG_IT11	PMDT4300	NLED17.3WXGA+G	N10MGS	512M-DDR3 (64*16*4)	SO2GBIi6	N500GB5.4KS	NSM8XS	5 in 1- Build in	3rd WiFi 1x2 BGN	N	GM45	ICH9M	6CELL2.2	65W	0.3M DV
AS7736ZG-434G50Mn	EMEA	Luxembourg	LX.PJA02.076	AS7736ZG-434G50Mn W7HP64ATLJ3 MC N10MGS512Cbk_V3 2*2G/500_L/ 6L2.2/5R/CB_bgn_0.3D_HG_IT41	PMDT4300	NLED17.3WXGA+G	N10MGS	512M-DDR3 (64*16*4)	SO2GBIi6	N500GB5.4KS	NSM8XS	5 in 1- Build in	3rd WiFi 1x2 BGN	N	GM45	ICH9M	6CELL2.2	65W	0.3M DV
AS7736ZG-434G50Mn	EMEA	Czech	LX.PJA02.077	AS7736ZG-434G50Mn W7HP64ATCZ2 MC N10MGS512Cbk_V3 2*2G/500_L/ 6L2.2/5R/CB_bgn_0.3D_HG_SK11	PMDT4300	NLED17.3WXGA+G	N10MGS	512M-DDR3 (64*16*4)	SO2GBIi6	N500GB5.4KS	NSM8XS	5 in 1- Build in	3rd WiFi 1x2 BGN	N	GM45	ICH9M	6CELL2.2	65W	0.3M DV
AS7736ZG-434G50Mn	EMEA	Cyprus	LX.PJA02.075	AS7736ZG-434G50Mn W7HP64ATCY1 MC N10MGS512Cbk_V3 2*2G/500_L/ 6L2.2/5R/CB_bgn_0.3D_HG_ES61	PMDT4300	NLED17.3WXGA+G	N10MGS	512M-DDR3 (64*16*4)	SO2GBIi6	N500GB5.4KS	NSM8XS	5 in 1- Build in	3rd WiFi 1x2 BGN	N	GM45	ICH9M	6CELL2.2	65W	0.3M DV
AS7736ZG-434G50Mn	EMEA	Finland	LX.PJA02.073	AS7736ZG-434G50Mn W7HP64ATF12 MC N10MGS512Cbk_V3 2*2G/500_L/ 6L2.2/5R/CB_bgn_0.3D_HG_F111	PMDT4300	NLED17.3WXGA+G	N10MGS	512M-DDR3 (64*16*4)	SO2GBIi6	N500GB5.4KS	NSM8XS	5 in 1- Build in	3rd WiFi 1x2 BGN	N	GM45	ICH9M	6CELL2.2	65W	0.3M DV
AS7736ZG-434G50Mn	EMEA	Norway	LX.PJA02.078	AS7736ZG-434G50Mn W7HP64ATNO1 MC N10MGS512Cbk_V3 2*2G/500_L/ 6L2.2/5R/CB_bgn_0.3D_HGO11	PMDT4300	NLED17.3WXGA+G	N10MGS	512M-DDR3 (64*16*4)	SO2GBIi6	N500GB5.4KS	NSM8XS	5 in 1- Build in	3rd WiFi 1x2 BGN	N	GM45	ICH9M	6CELL2.2	65W	0.3M DV
AS7736ZG-434G50Mn	EMEA	Austria	LX.PJA02.082	AS7736ZG-434G50Mn W7HP64ATAT1 MC N10MGS512Cbk_V3 2*2G/500_L/ 6L2.2/5R/CB_bgn_0.3D_HG_DE61	PMDT4300	NLED17.3WXGA+G	N10MGS	512M-DDR3 (64*16*4)	SO2GBIi6	N500GB5.4KS	NSM8XS	5 in 1- Build in	3rd WiFi 1x2 BGN	N	GM45	ICH9M	6CELL2.2	65W	0.3M DV
AS7736ZG-434G50Mn	EMEA	Eastern Europe	LX.PJA02.079	AS7736ZG-434G50Mn W7HP64ATEU4 MC N10MGS512Cbk_V3 2*2G/500_L/ 6L2.2/5R/CB_bgn_0.3D_HG_SV21	PMDT4300	NLED17.3WXGA+G	N10MGS	512M-DDR3 (64*16*4)	SO2GBIi6	N500GB5.4KS	NSM8XS	5 in 1- Build in	3rd WiFi 1x2 BGN	N	GM45	ICH9M	6CELL2.2	65W	0.3M DV
AS7736ZG-434G50Mn	EMEA	Portugal	LX.PJA02.084	AS7736ZG-434G50Mn W7HP64ATPT1 MC N10MGS512Cbk_V3 2*2G/500_L/ 6L2.2/5R/CB_bgn_0.3D_HG_PT11	PMDT4300	NLED17.3WXGA+G	N10MGS	512M-DDR3 (64*16*4)	SO2GBIi6	N500GB5.4KS	NSM8XS	5 in 1- Build in	3rd WiFi 1x2 BGN	N	GM45	ICH9M	6CELL2.2	65W	0.3M DV

AS7736ZG-434G50Mn	EMEA	Norway	LX.PJA02.086	AS7736ZG-434G50Mn W7HP64ATN03 MC N10MGS512Cbk_V3 2*2G/500_L/ 6L2.2/5R/CB_bgn_0.3D_HG_ENS1	PMDT4300	NLED17.3WXGA+G	N10MGS	512M-DDR3 (64*16*4)	SO2GBI6	N500GB5.4KS	NSM8XS	5 in 1- Build in	3rd WiFi 1x2 BGN	N	GM45	ICH9M	6CELL2.2	65W	0.3M DV
AS7736ZG-434G50Mn	EMEA	UK	LX.PJA02.081	AS7736ZG-434G50Mn W7HP64ATG81 MC N10MGS512Cbk_V3 2*2G/500_L/ 6L2.2/5R/CB_bgn_0.3D_HG_EN11	PMDT4300	NLED17.3WXGA+G	N10MGS	512M-DDR3 (64*16*4)	SO2GBI6	N500GB5.4KS	NSM8XS	5 in 1- Build in	3rd WiFi 1x2 BGN	N	GM45	ICH9M	6CELL2.2	65W	0.3M DV
AS7736ZG-434G50Mn	EMEA	France	LX.PJA02.080	AS7736ZG-434G50Mn W7HP64ATFR1 MC N10MGS512Cbk_V3 2*2G/500_L/ 6L2.2/5R/CB_bgn_0.3D_HG_FR21	PMDT4300	NLED17.3WXGA+G	N10MGS	512M-DDR3 (64*16*4)	SO2GBI6	N500GB5.4KS	NSM8XS	5 in 1- Build in	3rd WiFi 1x2 BGN	N	GM45	ICH9M	6CELL2.2	65W	0.3M DV
AS7736ZG-434G50Mn	EMEA	Germany	LX.PJA02.085	AS7736ZG-434G50Mn W7HP64ATDE1 MC N10MGS512Cbk_V3 2*2G/500_L/ 6L2.2/5R/CB_bgn_0.3D_HG_DE11	PMDT4300	NLED17.3WXGA+G	N10MGS	512M-DDR3 (64*16*4)	SO2GBI6	N500GB5.4KS	NSM8XS	5 in 1- Build in	3rd WiFi 1x2 BGN	N	GM45	ICH9M	6CELL2.2	65W	0.3M DV
AS7736ZG-434G50Mn	EMEA	Denmark	LX.PJA02.083	AS7736ZG-434G50Mn W7HP64ATDK2 MC N10MGS512Cbk_V3 2*2G/500_L/ 6L2.2/5R/CB_bgn_0.3D_HG_ENS1	PMDT4300	NLED17.3WXGA+G	N10MGS	512M-DDR3 (64*16*4)	SO2GBI6	N500GB5.4KS	NSM8XS	5 in 1- Build in	3rd WiFi 1x2 BGN	N	GM45	ICH9M	6CELL2.2	65W	0.3M DV
AS7736ZG-434G50Mn	EMEA	Spain	LX.PJA02.087	AS7736ZG-434G50Mn W7HP64ATES1 MC N10MGS512Cbk_V3 2*2G/500_L/ 6L2.2/5R/CB_bgn_0.3D_HG_ES51	PMDT4300	NLED17.3WXGA+G	N10MGS	512M-DDR3 (64*16*4)	SO2GBI6	N500GB5.4KS	NSM8XS	5 in 1- Build in	3rd WiFi 1x2 BGN	N	GM45	ICH9M	6CELL2.2	65W	0.3M DV
AS7736ZG-434G50Mn	EMEA	Hungary	LX.PJA02.088	AS7736ZG-434G50Mn W7HP64ATHU1 MC N10MGS512Cbk_V3 2*2G/500_L/ 6L2.2/5R/CB_bgn_0.3D_HG_HU11	PMDT4300	NLED17.3WXGA+G	N10MGS	512M-DDR3 (64*16*4)	SO2GBI6	N500GB5.4KS	NSM8XS	5 in 1- Build in	3rd WiFi 1x2 BGN	N	GM45	ICH9M	6CELL2.2	65W	0.3M DV
AS7736ZG-434G50Mn	EMEA	Israel	LX.PJA02.001	AS7736ZG-434G50Mn W7HP64ATIL1 MC N10MGS512Cbk_V3 2*2G/500_L/ 6L2.2/5R/CB_bgn_0.3D_HG_HE11	PMDT4300	NLED17.3WXGA+G	N10MGS	512M-DDR3 (64*16*4)	SO2GBI6	N500GB5.4KS	NSM8XS	5 in 1- Build in	3rd WiFi 1x2 BGN	N	GM45	ICH9M	6CELL2.2	65W	0.3M DV
AS7736ZG-434G50Mn	EMEA	Ukraine	LX.PJA02.004	AS7736ZG-434G50Mn W7HP64ATUK1 MC N10MGS512Cbk_V3 2*2G/500_L/ 6L2.2/5R/CB_bgn_0.3D_HG_RU61	PMDT4300	NLED17.3WXGA+G	N10MGS	512M-DDR3 (64*16*4)	SO2GBI6	N500GB5.4KS	NSM8XS	5 in 1- Build in	3rd WiFi 1x2 BGN	N	GM45	ICH9M	6CELL2.2	65W	0.3M DV
AS7736ZG-434G50Mi	EMEA	Russia	LX.PJA02.005	AS7736ZG-434G50Mi W7HP64ARU1 MC N10MGS512Cbk_V3 2*2G/500_L/ 6L2.2/5R/CB_bgn_0.3D_HG_RU11	PMDT4300	NLED17.3WXGA+G	N10MGS	512M-DDR3 (64*16*4)	SO2GBI6	N500GB5.4KS	NSM8XS	5 in 1- Build in	3rd WiFi BG	N	GM45	ICH9M	6CELL2.2	65W	0.3M DV
AS7736ZG-434G50Mn	EMEA	Israel	LX.PJA02.002	AS7736ZG-434G50Mn W7HP64ATIL1 MC N10MGS512Cbk_V3 2*2G/500_L/ 6L2.2/5R/CB_bgn_0.3D_HG_HE31	PMDT4300	NLED17.3WXGA+G	N10MGS	512M-DDR3 (64*16*4)	SO2GBI6	N500GB5.4KS	NSM8XS	5 in 1- Build in	3rd WiFi 1x2 BGN	N	GM45	ICH9M	6CELL2.2	65W	0.3M DV
AS7736ZG-434G50Mn	EMEA	Turkey	LX.PJA02.006	AS7736ZG-434G50Mn EM W7HP64EMATTR1 MC N10MGS512Cbk_V3 2*2G/500_L/ 6L2.2/5R/CB_bgn_0.3D_HG_TR31	PMDT4300	NLED17.3WXGA+G	N10MGS	512M-DDR3 (64*16*4)	SO2GBI6	N500GB5.4KS	NSM8XS	5 in 1- Build in	3rd WiFi 1x2 BGN	N	GM45	ICH9M	6CELL2.2	65W	0.3M DV
AS7736ZG-434G50Mn	EMEA	Serbia/ Macedonia	LX.PJA02.003	AS7736ZG-434G50Mn EM W7HP64ATCS1 MC N10MGS512Cbk_V3 2*2G/500_L/ 6L2.2/5R/CB_bgn_0.3D_HG_SL11	PMDT4300	NLED17.3WXGA+G	N10MGS	512M-DDR3 (64*16*4)	SO2GBI6	N500GB5.4KS	NSM8XS	5 in 1- Build in	3rd WiFi 1x2 BGN	N	GM45	ICH9M	6CELL2.2	65W	0.3M DV
AS7736ZG-434G50Mn	EMEA	Middle East	LX.PJA02.007	AS7736ZG-434G50Mn EM W7HP64EMATME6 MC N10MGS512Cbk_V3 2*2G/500_L/ 6L2.2/5R/CB_bgn_0.3D_HG_ES61	PMDT4300	NLED17.3WXGA+G	N10MGS	512M-DDR3 (64*16*4)	SO2GBI6	N500GB5.4KS	NSM8XS	5 in 1- Build in	3rd WiFi 1x2 BGN	N	GM45	ICH9M	6CELL2.2	65W	0.3M DV
AS7736ZG-434G50Mn	EMEA	Middle East	LX.PJA02.009	AS7736ZG-434G50Mn EM W7HP64EMATME2 MC N10MGS512Cbk_V3 2*2G/500_L/ 6L2.2/5R/CB_bgn_0.3D_HG_AR11	PMDT4300	NLED17.3WXGA+G	N10MGS	512M-DDR3 (64*16*4)	SO2GBI6	N500GB5.4KS	NSM8XS	5 in 1- Build in	3rd WiFi 1x2 BGN	N	GM45	ICH9M	6CELL2.2	65W	0.3M DV
AS7736ZG-434G50Mn	EMEA	Middle East	LX.PJA02.015	AS7736ZG-434G50Mn EM W7HP64EMATME3 MC N10MGS512Cbk_V3 2*2G/500_L/ 6L2.2/5R/CB_bgn_0.3D_HG_ES81	PMDT4300	NLED17.3WXGA+G	N10MGS	512M-DDR3 (64*16*4)	SO2GBI6	N500GB5.4KS	NSM8XS	5 in 1- Build in	3rd WiFi 1x2 BGN	N	GM45	ICH9M	6CELL2.2	65W	0.3M DV
AS7736ZG-434G50Mn	EMEA	Middle East	LX.PJA02.013	AS7736ZG-434G50Mn EM W7HP64EMATME2 MC N10MGS512Cbk_V3 2*2G/500_L/ 6L2.2/5R/CB_bgn_0.3D_HG_ES61	PMDT4300	NLED17.3WXGA+G	N10MGS	512M-DDR3 (64*16*4)	SO2GBI6	N500GB5.4KS	NSM8XS	5 in 1- Build in	3rd WiFi 1x2 BGN	N	GM45	ICH9M	6CELL2.2	65W	0.3M DV

AS7736ZG-434G50Mn	EMEA	Middle East	LX.PJA02.014	AS7736ZG-434G50Mn EM W7HP64EMATME4 MC N10MGS512Cbk_V3 2*2G/500_L/ 6L2.2/5R/CB_bgn_0.3D_HG_RU61	PMDT4300	NLED17.3WXGA+G	N10MGS	512M-DDR3 (64*16*4)	SO2GBIi6	N500GB5.4KS	NSM8XS	5 in 1- Build in	3rd WiFi 1x2 BGN	N	GM45	ICH9M	6CELL2.2	65W	0.3M DV
AS7736ZG-434G50Mn	EMEA	Middle East	LX.PJA02.010	AS7736ZG-434G50Mn EM W7HP64EMATME4 MC N10MGS512Cbk_V3 2*2G/500_L/ 6L2.2/5R/CB_bgn_0.3D_HG_ES61	PMDT4300	NLED17.3WXGA+G	N10MGS	512M-DDR3 (64*16*4)	SO2GBIi6	N500GB5.4KS	NSM8XS	5 in 1- Build in	3rd WiFi 1x2 BGN	N	GM45	ICH9M	6CELL2.2	65W	0.3M DV
AS7736ZG-434G50Mn	EMEA	Algeria	LX.PJA02.012	AS7736ZG-434G50Mn EM W7HP64EMATDZ1 MC N10MGS512Cbk_V3 2*2G/500_L/ 6L2.2/5R/CB_bgn_0.3D_HG_ES81	PMDT4300	NLED17.3WXGA+G	N10MGS	512M-DDR3 (64*16*4)	SO2GBIi6	N500GB5.4KS	NSM8XS	5 in 1- Build in	3rd WiFi 1x2 BGN	N	GM45	ICH9M	6CELL2.2	65W	0.3M DV
AS7736ZG-434G50Mn	EMEA	Middle East	LX.PJA02.011	AS7736ZG-434G50Mn EM W7HP64EMATME9 MC N10MGS512Cbk_V3 2*2G/500_L/ 6L2.2/5R/CB_bgn_0.3D_HG_ES81	PMDT4300	NLED17.3WXGA+G	N10MGS	512M-DDR3 (64*16*4)	SO2GBIi6	N500GB5.4KS	NSM8XS	5 in 1- Build in	3rd WiFi 1x2 BGN	N	GM45	ICH9M	6CELL2.2	65W	0.3M DV
AS7736ZG-434G50Mn	EMEA	South Africa	LX.PJA02.016	AS7736ZG-434G50Mn EM W7HP64EMATZA4 MC N10MGS512Cbk_V3 2*2G/500_L/ 6L2.2/5R/CB_bgn_0.3D_HG_ES61	PMDT4300	NLED17.3WXGA+G	N10MGS	512M-DDR3 (64*16*4)	SO2GBIi6	N500GB5.4KS	NSM8XS	5 in 1- Build in	3rd WiFi 1x2 BGN	N	GM45	ICH9M	6CELL2.2	65W	0.3M DV
AS7736ZG-434G50Mn	EMEA	South Africa	LX.PJA02.017	AS7736ZG-434G50Mn EM W7HP64EMATZA1 MC N10MGS512Cbk_V3 2*2G/500_L/ 6L2.2/5R/CB_bgn_0.3D_HG_ES81	PMDT4300	NLED17.3WXGA+G	N10MGS	512M-DDR3 (64*16*4)	SO2GBIi6	N500GB5.4KS	NSM8XS	5 in 1- Build in	3rd WiFi 1x2 BGN	N	GM45	ICH9M	6CELL2.2	65W	0.3M DV
AS7736ZG-434G50Mn	EMEA	South Africa	LX.PJA02.018	AS7736ZG-434G50Mn EM W7HP64EMATZA2 MC N10MGS512Cbk_V3 2*2G/500_L/ 6L2.2/5R/CB_bgn_0.3D_HG_ES61	PMDT4300	NLED17.3WXGA+G	N10MGS	512M-DDR3 (64*16*4)	SO2GBIi6	N500GB5.4KS	NSM8XS	5 in 1- Build in	3rd WiFi 1x2 BGN	N	GM45	ICH9M	6CELL2.2	65W	0.3M DV
AS7736ZG-434G50Mn	EMEA	Cyprus	LX.PJA02.020	AS7736ZG-434G50Mn W7HP64ATCY1 MC N10MGS512Cbk_V3 2*2G/500_L/ 6L2.2/5R/CB_bgn_0.3D_HG_ES61	PMDT4300	NLED17.3WXGA+G	N10MGS	512M-DDR3 (64*16*4)	SO2GBIi6	N500GB5.4KS	NSM8XS	5 in 1- Build in	3rd WiFi 1x2 BGN	N	GM45	ICH9M	6CELL2.2	65W	0.3M DV
AS7736ZG-434G50Mn	EMEA	Portugal	LX.PJA02.021	AS7736ZG-434G50Mn W7HP64ATPT1 MC N10MGS512Cbk_V3 2*2G/500_L/ 6L2.2/5R/CB_bgn_0.3D_HG_PT11	PMDT4300	NLED17.3WXGA+G	N10MGS	512M-DDR3 (64*16*4)	SO2GBIi6	N500GB5.4KS	NSM8XS	5 in 1- Build in	3rd WiFi 1x2 BGN	N	GM45	ICH9M	6CELL2.2	65W	0.3M DV
AS7736ZG-434G50Mn	EMEA	Poland	LX.PJA02.019	AS7736ZG-434G50Mn W7HP64ATPL1 MC N10MGS512Cbk_V3 2*2G/500_L/ 6L2.2/5R/CB_bgn_0.3D_HG_PL11	PMDT4300	NLED17.3WXGA+G	N10MGS	512M-DDR3 (64*16*4)	SO2GBIi6	N500GB5.4KS	NSM8XS	5 in 1- Build in	3rd WiFi 1x2 BGN	N	GM45	ICH9M	6CELL2.2	65W	0.3M DV
AS7736ZG-434G50Mn	EMEA	Greece	LX.PJA02.024	AS7736ZG-434G50Mn W7HP64ATGR1 MC N10MGS512Cbk_V3 2*2G/500_L/ 6L2.2/5R/CB_bgn_0.3D_HG_EL31	PMDT4300	NLED17.3WXGA+G	N10MGS	512M-DDR3 (64*16*4)	SO2GBIi6	N500GB5.4KS	NSM8XS	5 in 1- Build in	3rd WiFi 1x2 BGN	N	GM45	ICH9M	6CELL2.2	65W	0.3M DV
AS7736ZG-434G50Mn	EMEA	Italy	LX.PJA02.025	AS7736ZG-434G50Mn W7HP64ATIT1 MC N10MGS512Cbk_V3 2*2G/500_L/ 6L2.2/5R/CB_bgn_0.3D_HG_IT11	PMDT4300	NLED17.3WXGA+G	N10MGS	512M-DDR3 (64*16*4)	SO2GBIi6	N500GB5.4KS	NSM8XS	5 in 1- Build in	3rd WiFi 1x2 BGN	N	GM45	ICH9M	6CELL2.2	65W	0.3M DV
AS7736ZG-434G50Mn	EMEA	Spain	LX.PJA02.023	AS7736ZG-434G50Mn W7HP64ATES1 MC N10MGS512Cbk_V3 2*2G/500_L/ 6L2.2/5R/CB_bgn_0.3D_HG_ES51	PMDT4300	NLED17.3WXGA+G	N10MGS	512M-DDR3 (64*16*4)	SO2GBIi6	N500GB5.4KS	NSM8XS	5 in 1- Build in	3rd WiFi 1x2 BGN	N	GM45	ICH9M	6CELL2.2	65W	0.3M DV
AS7736ZG-434G50Mn	EMEA	Hungary	LX.PJA02.022	AS7736ZG-434G50Mn W7HP64ATHU1 MC N10MGS512Cbk_V3 2*2G/500_L/ 6L2.2/5R/CB_bgn_0.3D_HG_HU11	PMDT4300	NLED17.3WXGA+G	N10MGS	512M-DDR3 (64*16*4)	SO2GBIi6	N500GB5.4KS	NSM8XS	5 in 1- Build in	3rd WiFi 1x2 BGN	N	GM45	ICH9M	6CELL2.2	65W	0.3M DV
AS7736ZG-434G50Mn	EMEA	Eastern Europe	LX.PJA02.027	AS7736ZG-434G50Mn W7HP64ATEU5 MC N10MGS512Cbk_V3 2*2G/500_L/ 6L2.2/5R/CB_bgn_0.3D_HG_RO11	PMDT4300	NLED17.3WXGA+G	N10MGS	512M-DDR3 (64*16*4)	SO2GBIi6	N500GB5.4KS	NSM8XS	5 in 1- Build in	3rd WiFi 1x2 BGN	N	GM45	ICH9M	6CELL2.2	65W	0.3M DV
AS7736ZG-434G50Mn	EMEA	Eastern Europe	LX.PJA02.028	AS7736ZG-434G50Mn W7HP64ATEU5 MC N10MGS512Cbk_V3 2*2G/500_L/ 6L2.2/5R/CB_bgn_0.3D_HG_PL71	PMDT4300	NLED17.3WXGA+G	N10MGS	512M-DDR3 (64*16*4)	SO2GBIi6	N500GB5.4KS	NSM8XS	5 in 1- Build in	3rd WiFi 1x2 BGN	N	GM45	ICH9M	6CELL2.2	65W	0.3M DV
AS7736ZG-434G50Mn	EMEA	Eastern Europe	LX.PJA02.035	AS7736ZG-434G50Mn W7HP64ATEU4 MC N10MGS512Cbk_V3 2*2G/500_L/ 6L2.2/5R/CB_bgn_0.3D_HG_SV21	PMDT4300	NLED17.3WXGA+G	N10MGS	512M-DDR3 (64*16*4)	SO2GBIi6	N500GB5.4KS	NSM8XS	5 in 1- Build in	3rd WiFi 1x2 BGN	N	GM45	ICH9M	6CELL2.2	65W	0.3M DV

AS7736ZG-434G50Mn	EMEA	Eastern Europe	LX.PJA02.029	AS7736ZG-434G50Mn W7HP64TEU7 MC N10MGS512Cbk_V3 2*2G/500_L/ 6L2.2/5R/CB_bgn_0.3D_HG_ENQ1	PMDT4300	NLED17.3WXGA+G	N10MGS	512M-DDR3 (64*16*4)	SO2GBI6	N500GB5.4KS	NSM8XS	5 in 1- Build in	3rd WiFi 1x2 BGN	N	GM45	ICH9M	6CELL2.2	65W	0.3M DV
AS7736ZG-434G50Mn	EMEA	Finland	LX.PJA02.026	AS7736ZG-434G50Mn W7HP64TFI2 MC N10MGS512Cbk_V3 2*2G/500_L/ 6L2.2/5R/CB_bgn_0.3D_HG_FI11	PMDT4300	NLED17.3WXGA+G	N10MGS	512M-DDR3 (64*16*4)	SO2GBI6	N500GB5.4KS	NSM8XS	5 in 1- Build in	3rd WiFi 1x2 BGN	N	GM45	ICH9M	6CELL2.2	65W	0.3M DV
AS7736ZG-434G50Mn	EMEA	Eastern Europe	LX.PJA02.034	AS7736ZG-434G50Mn W7HP64TEU7 MC N10MGS512Cbk_V3 2*2G/500_L/ 6L2.2/5R/CB_bgn_0.3D_HG_SL11	PMDT4300	NLED17.3WXGA+G	N10MGS	512M-DDR3 (64*16*4)	SO2GBI6	N500GB5.4KS	NSM8XS	5 in 1- Build in	3rd WiFi 1x2 BGN	N	GM45	ICH9M	6CELL2.2	65W	0.3M DV
AS7736ZG-434G50Mn	EMEA	Czech	LX.PJA02.030	AS7736ZG-434G50Mn W7HP64ATCZ2 MC N10MGS512Cbk_V3 2*2G/500_L/ 6L2.2/5R/CB_bgn_0.3D_HG_SK11	PMDT4300	NLED17.3WXGA+G	N10MGS	512M-DDR3 (64*16*4)	SO2GBI6	N500GB5.4KS	NSM8XS	5 in 1- Build in	3rd WiFi 1x2 BGN	N	GM45	ICH9M	6CELL2.2	65W	0.3M DV
AS7736ZG-434G50Mn	EMEA	Norway	LX.PJA02.032	AS7736ZG-434G50Mn W7HP64ATN03 MC N10MGS512Cbk_V3 2*2G/500_L/ 6L2.2/5R/CB_bgn_0.3D_HG_ENS1	PMDT4300	NLED17.3WXGA+G	N10MGS	512M-DDR3 (64*16*4)	SO2GBI6	N500GB5.4KS	NSM8XS	5 in 1- Build in	3rd WiFi 1x2 BGN	N	GM45	ICH9M	6CELL2.2	65W	0.3M DV
AS7736ZG-434G50Mn	EMEA	Austria	LX.PJA02.031	AS7736ZG-434G50Mn W7HP64ATAT1 MC N10MGS512Cbk_V3 2*2G/500_L/ 6L2.2/5R/CB_bgn_0.3D_HG_DE61	PMDT4300	NLED17.3WXGA+G	N10MGS	512M-DDR3 (64*16*4)	SO2GBI6	N500GB5.4KS	NSM8XS	5 in 1- Build in	3rd WiFi 1x2 BGN	N	GM45	ICH9M	6CELL2.2	65W	0.3M DV
AS7736ZG-434G50Mn	EMEA	Belgium	LX.PJA02.044	AS7736ZG-434G50Mn W7HP64ATBE1 MC N10MGS512Cbk_V3 2*2G/500_L/ 6L2.2/5R/CB_bgn_0.3D_HG_NL11	PMDT4300	NLED17.3WXGA+G	N10MGS	512M-DDR3 (64*16*4)	SO2GBI6	N500GB5.4KS	NSM8XS	5 in 1- Build in	3rd WiFi 1x2 BGN	N	GM45	ICH9M	6CELL2.2	65W	0.3M DV
AS7736ZG-434G50Mn	EMEA	Norway	LX.PJA02.036	AS7736ZG-434G50Mn W7HP64ATN01 MC N10MGS512Cbk_V3 2*2G/500_L/ 6L2.2/5R/CB_bgn_0.3D_HG_NO11	PMDT4300	NLED17.3WXGA+G	N10MGS	512M-DDR3 (64*16*4)	SO2GBI6	N500GB5.4KS	NSM8XS	5 in 1- Build in	3rd WiFi 1x2 BGN	N	GM45	ICH9M	6CELL2.2	65W	0.3M DV
AS7736ZG-434G50Mn	EMEA	Holland	LX.PJA02.038	AS7736ZG-434G50Mn W7HP64ATNL1 MC N10MGS512Cbk_V3 2*2G/500_L/ 6L2.2/5R/CB_bgn_0.3D_HG_NL11	PMDT4300	NLED17.3WXGA+G	N10MGS	512M-DDR3 (64*16*4)	SO2GBI6	N500GB5.4KS	NSM8XS	5 in 1- Build in	3rd WiFi 1x2 BGN	N	GM45	ICH9M	6CELL2.2	65W	0.3M DV
AS7736ZG-434G50Mn	EMEA	Luxembourg	LX.PJA02.037	AS7736ZG-434G50Mn W7HP64ATLJ3 MC N10MGS512Cbk_V3 2*2G/500_L/ 6L2.2/5R/CB_bgn_0.3D_HG_IT41	PMDT4300	NLED17.3WXGA+G	N10MGS	512M-DDR3 (64*16*4)	SO2GBI6	N500GB5.4KS	NSM8XS	5 in 1- Build in	3rd WiFi 1x2 BGN	N	GM45	ICH9M	6CELL2.2	65W	0.3M DV
AS7736ZG-434G50Mn	EMEA	Germany	LX.PJA02.039	AS7736ZG-434G50Mn W7HP64ATDE1 MC N10MGS512Cbk_V3 2*2G/500_L/ 6L2.2/5R/CB_bgn_0.3D_HG_DE11	PMDT4300	NLED17.3WXGA+G	N10MGS	512M-DDR3 (64*16*4)	SO2GBI6	N500GB5.4KS	NSM8XS	5 in 1- Build in	3rd WiFi 1x2 BGN	N	GM45	ICH9M	6CELL2.2	65W	0.3M DV
AS7736ZG-434G50Mn	EMEA	Denmark	LX.PJA02.045	AS7736ZG-434G50Mn W7HP64ATDK1 MC N10MGS512Cbk_V3 2*2G/500_L/ 6L2.2/5R/CB_bgn_0.3D_HG_NO11	PMDT4300	NLED17.3WXGA+G	N10MGS	512M-DDR3 (64*16*4)	SO2GBI6	N500GB5.4KS	NSM8XS	5 in 1- Build in	3rd WiFi 1x2 BGN	N	GM45	ICH9M	6CELL2.2	65W	0.3M DV
AS7736ZG-434G50Mn	EMEA	Denmark	LX.PJA02.040	AS7736ZG-434G50Mn W7HP64ATDK2 MC N10MGS512Cbk_V3 2*2G/500_L/ 6L2.2/5R/CB_bgn_0.3D_HG_ENS1	PMDT4300	NLED17.3WXGA+G	N10MGS	512M-DDR3 (64*16*4)	SO2GBI6	N500GB5.4KS	NSM8XS	5 in 1- Build in	3rd WiFi 1x2 BGN	N	GM45	ICH9M	6CELL2.2	65W	0.3M DV
AS7736ZG-423G32Mn	WW	GCTWN	S2.PJA02.001	AS7736ZG-423G32Mn W7HP64AWW1 MC N10MGS512Cbk_V3 2G+1G/320/BT/ 6L2.2/5R/CB_bgn_0.3D_HG_ES61	PMDT4200	NLED17.3WXGA+G	N10MGS	512M-DDR3 (64*16*4)	SO2GBI6	N320GB5.4KS	NSM8XS	5 in 1- Build in	3rd WiFi 1x2 BGN	BT 2.1/N	GM45	ICH9M	6CELL2.2	65W	0.3M DV
AS7736ZG-423G32Mn	WW	WW	S2.PJA02.002	AS7736ZG-423G32Mn W7HP64AWW1 MC N10MGS512Cbk_V3 2G+1G/320/BT/ 6L2.2/5R/CB_bgn_0.3D_HG_ES62	PMDT4200	NLED17.3WXGA+G	N10MGS	512M-DDR3 (64*16*4)	SO2GBI6	N320GB5.4KS	NSM8XS	5 in 1- Build in	3rd WiFi 1x2 BGN	BT 2.1/N	GM45	ICH9M	6CELL2.2	65W	0.3M DV
AS7736ZG-434G50Mn	EMEA	Switzerland	LX.PJA02.042	AS7736ZG-434G50Mn W7HP64ATCH1 MC N10MGS512Cbk_V3 2*2G/500_L/ 6L2.2/5R/CB_bgn_0.3D_HG_IT41	PMDT4300	NLED17.3WXGA+G	N10MGS	512M-DDR3 (64*16*4)	SO2GBI6	N500GB5.4KS	NSM8XS	5 in 1- Build in	3rd WiFi 1x2 BGN	N	GM45	ICH9M	6CELL2.2	65W	0.3M DV
AS7736ZG-434G50Mn	EMEA	UK	LX.PJA02.041	AS7736ZG-434G50Mn W7HP64ATGB1 MC N10MGS512Cbk_V3 2*2G/500_L/ 6L2.2/5R/CB_bgn_0.3D_HG_EN11	PMDT4300	NLED17.3WXGA+G	N10MGS	512M-DDR3 (64*16*4)	SO2GBI6	N500GB5.4KS	NSM8XS	5 in 1- Build in	3rd WiFi 1x2 BGN	N	GM45	ICH9M	6CELL2.2	65W	0.3M DV

AS7736Z-434G32Mn	EMEA	Eastern Europe	LX.PJA0C.002	AS7736ZG-434G32Mn LNPUSAEU7 N10MGS512CbK_V3 2*2G/320/BT/ 6L2.2/5R/CB_bgn_0.3D_HG_ENQ1	PMDT4300	NLED17.3WXGA+G	N10MGS	512M-DDR3 (64*16*4)	SO2GBI6	N320GB5.4KS	NSM8XS	5 in 1- Build in	3rd WiFi 1x2 BGN	BT 2.1/N	GM45	ICH9M	6CELL2.2	65W	0.3M DV
AS7736Z-434G32Bn	EMEA	Eastern Europe	LX.PJA0C.003	AS7736ZG-434G32Bn LNPUSAEU7 N10MGS512CbK_V3 2*2G/320/BT/ 6L2.2/5R/CB_bgn_0.3D_HG_EN11	PMDT4300	NLED17.3WXGA+G	N10MGS	512M-DDR3 (64*16*4)	SO2GBI6	N320GB5.4KS	NBDCB4XS	5 in 1- Build in	3rd WiFi 1x2 BGN	BT 2.1/N	GM45	ICH9M	6CELL2.2	65W	0.3M DV
AS7736ZG-432G32Mn	EMEA	Eastern Europe	LX.PJA0C.001	AS7736ZG-432G32Mn LNPUSAEU7 N10MGS512CbK_V3 1*2G/320/BT/ 6L2.2/5R/CB_bgn_0.3D_N_HG_ENQ1	PMDT4300	NLED17.3WXGA+G	N10MGS	512M-DDR3 (64*16*4)	SO2GBI6/ N	N320GB5.4KS	NSM8XS	5 in 1- Build in	3rd WiFi 1x2 BGN	BT 2.1/N	GM45	ICH9M	6CELL2.2	65W	0.3M DV
AS7736Z-434G32Mn	PA	Canada	LX.PJB02.106	AS7736Z-434G32Mn W7HP64ATCA2 MC UMACbk 2*2G/320/6L2.2/5R/ CB_bgn_0.3D_HG_FR82	PMDT4300	NLED17.3WXGA+G	UMA	N	SO2GBI6	N320GB5.4KS	NSM8XS	5 in 1- Build in	3rd WiFi 1x2 BGN	N	GL40(A1)	ICH9M	6CELL2.2	65W	0.3M DV
AS7736Z-434G32Mn	EMEA	Switzerland	LX.PJB02.097	AS7736Z-434G32Mn W7HP64ATCH1 MC UMACbk 2*2G/320/6L2.2/5R/ CB_bgn_0.3D_HG_IT41	PMDT4300	NLED17.3WXGA+G	UMA	N	SO2GBI6	N320GB5.4KS	NSM8XS	5 in 1- Build in	3rd WiFi 1x2 BGN	N	GL40(A1)	ICH9M	6CELL2.2	65W	0.3M DV
AS7736Z-434G32Mn	EMEA	France	LX.PJB02.046	AS7736Z-434G32Mn W7HP64ATFR1 MC UMACbk 2*2G/320/6L2.2/5R/ CB_bgn_0.3D_HG_FR21	PMDT4300	NLED17.3WXGA+G	UMA	N	SO2GBI6	N320GB5.4KS	NSM8XS	5 in 1- Build in	3rd WiFi 1x2 BGN	N	GL40(A1)	ICH9M	6CELL2.2	65W	0.3M DV
AS7736Z-434G50Mn	PA	USA	LX.PJB02.105	AS7736Z-434G50Mn W7HP64ATUS1 MC UMACbk 2*2G/500_L/6L2.2/5R/ CB_bgn_0.3D_HG_FRB3	PMDT4300	NLED17.3WXGA+G	UMA	N	SO2GBI6	N500GB5.4KS	NSM8XS	5 in 1- Build in	3rd WiFi 1x2 BGN	N	GL40(A1)	ICH9M	6CELL2.2	65W	0.3M DV
AS7736Z-434G50Mn	PA	USA	LX.PJB02.104	AS7736Z-434G50Mn W7HP64ATUS1 MC UMACbk 2*2G/500_L/6L2.2/5R/ CB_bgn_0.3D_HG_FRB2	PMDT4300	NLED17.3WXGA+G	UMA	N	SO2GBI6	N500GB5.4KS	NSM8XS	5 in 1- Build in	3rd WiFi 1x2 BGN	N	GL40(A1)	ICH9M	6CELL2.2	65W	0.3M DV
AS7736Z-434G50Mn	PA	USA	LX.PJB02.103	AS7736Z-434G50Mn W7HP64ATUS1 MC UMACbk 2*2G/500_L/6L2.2/5R/ CB_bgn_0.3D_HG_FRB1	PMDT4300	NLED17.3WXGA+G	UMA	N	SO2GBI6	N500GB5.4KS	NSM8XS	5 in 1- Build in	3rd WiFi 1x2 BGN	N	GL40(A1)	ICH9M	6CELL2.2	65W	0.3M DV
AS7736Z-434G50Mn	PA	Canada	LX.PJB02.102	AS7736Z-434G50Mn W7HP64ATCA2 MC UMACbk 2*2G/500_L/6L2.2/5R/ CB_bgn_0.3D_HG_FR84	PMDT4300	NLED17.3WXGA+G	UMA	N	SO2GBI6	N500GB5.4KS	NSM8XS	5 in 1- Build in	3rd WiFi 1x2 BGN	N	GL40(A1)	ICH9M	6CELL2.2	65W	0.3M DV
AS7736Z-434G50Mn	PA	Canada	LX.PJB02.099	AS7736Z-434G50Mn W7HP64ATCA2 MC UMACbk 2*2G/500_L/6L2.2/5R/ CB_bgn_0.3D_HG_FR81	PMDT4300	NLED17.3WXGA+G	UMA	N	SO2GBI6	N500GB5.4KS	NSM8XS	5 in 1- Build in	3rd WiFi 1x2 BGN	N	GL40(A1)	ICH9M	6CELL2.2	65W	0.3M DV
AS7736Z-434G50Mn	PA	Canada	LX.PJB02.101	AS7736Z-434G50Mn W7HP64ATCA2 MC UMACbk 2*2G/500_L/6L2.2/5R/ CB_bgn_0.3D_HG_FR82	PMDT4300	NLED17.3WXGA+G	UMA	N	SO2GBI6	N500GB5.4KS	NSM8XS	5 in 1- Build in	3rd WiFi 1x2 BGN	N	GL40(A1)	ICH9M	6CELL2.2	65W	0.3M DV
AS7736Z-433G32Mn	EMEA	Middle East	LX.PJB02.098	AS7736Z-433G32Mn EM W7HP64EMATME2 MC UMACbk 2G+1G/320/BT/6L2.2/5R/ CB_bgn_0.3D_HG_AR21	PMDT4300	NLED17.3WXGA+G	UMA	N	SO2GBI6/ SO1GBI6	N320GB5.4KS	NSM8XS	5 in 1- Build in	3rd WiFi 1x2 BGN	BT 2.1/N	GL40(A1)	ICH9M	6CELL2.2	65W	0.3M DV
AS7736Z-432G25Mn	EMEA	Eastern Europe	LX.PJB0C.004	AS7736Z-432G25Mn LNPUSAEU7 UMACbk 1*2G/250/BT/6L2.2/5R/ CB_bgn_0.3D_HG_ENQ1	PMDT4300	NLED17.3WXGA+G	UMA	N	SO2GBI6/ N	N250GB5.4KS	NSM8XS	5 in 1- Build in	3rd WiFi 1x2 BGN	BT 2.1/N	GL40(A1)	ICH9M	6CELL2.2	65W	0.3M DV
AS7736Z-433G25Mn	EMEA	Middle East	LX.PJB02.056	AS7736Z-433G25Mn EM W7HP64EMATME2 MC UMACbk 2G+1G/250/6L2.2/5R/ CB_bgn_0.3D_HG_AR21	PMDT4300	NLED17.3WXGA+G	UMA	N	SO2GBI6/ SO1GBI6	N250GB5.4KS	NSM8XS	5 in 1- Build in	3rd WiFi 1x2 BGN	N	GL40(A1)	ICH9M	6CELL2.2	65W	0.3M DV
AS7736Z-433G32Mn	EMEA	Middle East	LX.PJB02.008	AS7736Z-433G32Mn EM W7HP64EMATME2 MC UMACbk 2G+1G/320/6L2.2/5R/ CB_bgn_0.3D_HG_AR21	PMDT4300	NLED17.3WXGA+G	UMA	N	SO2GBI6/ SO1GBI6	N320GB5.4KS	NSM8XS	5 in 1- Build in	3rd WiFi 1x2 BGN	N	GL40(A1)	ICH9M	6CELL2.2	65W	0.3M DV
AS7736Z-432G32Mn	EMEA	Switzerland	LX.PJB02.096	AS7736Z-432G32Mn W7HP64ATCH1 MC UMACbk 1*2G/320/6L2.2/5R/ CB_bgn_0.3D_HG_IT41	PMDT4300	NLED17.3WXGA+G	UMA	N	SO2GBI6/ N	N320GB5.4KS	NSM8XS	5 in 1- Build in	3rd WiFi 1x2 BGN	N	GL40(A1)	ICH9M	6CELL2.2	65W	0.3M DV
AS7736Z-434G32Mn	PA	USA	LX.PJB02.092	AS7736Z-434G32Mn W7HP64ATUS1 MC UMACbk 2*2G/320/6L2.2/5R/ CB_bgn_0.3D_HG_FRB1	PMDT4300	NLED17.3WXGA+G	UMA	N	SO2GBI6	N320GB5.4KS	NSM8XS	5 in 1- Build in	3rd WiFi 1x2 BGN	N	GL40(A1)	ICH9M	6CELL2.2	65W	0.3M DV
AS7736Z-433G32Mn	EMEA	Spain	LX.PJB02.091	AS7736Z-433G32Mn W7HP64ATES1 MC UMACbk 2G+1G/320/6L2.2/5R/ CB_bgn_0.3D_HG_ES51	PMDT4300	NLED17.3WXGA+G	UMA	N	SO2GBI6/ SO1GBI6	N320GB5.4KS	NSM8XS	5 in 1- Build in	3rd WiFi 1x2 BGN	N	GL40(A1)	ICH9M	6CELL2.2	65W	0.3M DV
AS7736Z-433G25Mn	EMEA	Ukraine	LX.PJB02.050	AS7736Z-433G25Mn W7HP64URATUK1 MC UMACbk 2G+1G/250/6L2.2/5R/ CB_bgn_0.3D_HG_RU61	PMDT4300	NLED17.3WXGA+G	UMA	N	SO2GBI6/ SO1GBI6	N250GB5.4KS	NSM8XS	5 in 1- Build in	3rd WiFi 1x2 BGN	N	GL40(A1)	ICH9M	6CELL2.2	65W	0.3M DV

AS7736Z-433G25Mn	EMEA	Algeria	LX.PJB02.051	AS7736Z-433G25Mn EM W7HP64EMATDZ1 MC UMACbck 2G+1G/250/6L2.2/5R/ CB_bgn_0.3D_HG_ES81	PMDT4300	NLED17.3WXGA+G	UMA	N	SO2GBI6/ SO1GBI6	N250GB5.4KS	NSM8XS	5 in 1- Build in	3rd WiFi 1x2 BGN	N	GL40(A1)	ICH9M	6CELL2.2	65W	0.3M DV
AS7736Z-433G25Mi	EMEA	Russia	LX.PJB02.049	AS7736Z-433G25Mi W7HP64RUATRU1 MC UMACbck 2G+1G/250/6L2.2/5R/ CB_bg_0.3D_HG_RU11	PMDT4300	NLED17.3WXGA+G	UMA	N	SO2GBI6/ SO1GBI6	N250GB5.4KS	NSM8XS	5 in 1- Build in	3rd WiFi BG	N	GL40(A1)	ICH9M	6CELL2.2	65W	0.3M DV
AS7736Z-433G25Mn	EMEA	South Africa	LX.PJB02.052	AS7736Z-433G25Mn EM W7HP64EMATZA1 MC UMACbck 2G+1G/250/6L2.2/5R/ CB_bgn_0.3D_HG_ES81	PMDT4300	NLED17.3WXGA+G	UMA	N	SO2GBI6/ SO1GBI6	N250GB5.4KS	NSM8XS	5 in 1- Build in	3rd WiFi 1x2 BGN	N	GL40(A1)	ICH9M	6CELL2.2	65W	0.3M DV
AS7736Z-433G25Mn	EMEA	Middle East	LX.PJB02.053	AS7736Z-433G25Mn EM W7HP64EMATME4 MC UMACbck 2G+1G/250/6L2.2/5R/ CB_bgn_0.3D_HG_RU61	PMDT4300	NLED17.3WXGA+G	UMA	N	SO2GBI6/ SO1GBI6	N250GB5.4KS	NSM8XS	5 in 1- Build in	3rd WiFi 1x2 BGN	N	GL40(A1)	ICH9M	6CELL2.2	65W	0.3M DV
AS7736Z-433G25Mn	EMEA	Turkey	LX.PJB02.060	AS7736Z-433G25Mn EM W7HP64EMATTR1 MC UMACbck 2G+1G/250/6L2.2/5R/ CB_bgn_0.3D_HG_TR31	PMDT4300	NLED17.3WXGA+G	UMA	N	SO2GBI6/ SO1GBI6	N250GB5.4KS	NSM8XS	5 in 1- Build in	3rd WiFi 1x2 BGN	N	GL40(A1)	ICH9M	6CELL2.2	65W	0.3M DV
AS7736Z-433G25Mn	EMEA	Middle East	LX.PJB02.057	AS7736Z-433G25Mn EM W7HP64EMATME3 MC UMACbck 2G+1G/250/6L2.2/5R/ CB_bgn_0.3D_HG_ES81	PMDT4300	NLED17.3WXGA+G	UMA	N	SO2GBI6/ SO1GBI6	N250GB5.4KS	NSM8XS	5 in 1- Build in	3rd WiFi 1x2 BGN	N	GL40(A1)	ICH9M	6CELL2.2	65W	0.3M DV
AS7736Z-433G25Mn	EMEA	South Africa	LX.PJB02.055	AS7736Z-433G25Mn EM W7HP64EMATZA4 MC UMACbck 2G+1G/250/6L2.2/5R/ CB_bgn_0.3D_HG_ES61	PMDT4300	NLED17.3WXGA+G	UMA	N	SO2GBI6/ SO1GBI6	N250GB5.4KS	NSM8XS	5 in 1- Build in	3rd WiFi 1x2 BGN	N	GL40(A1)	ICH9M	6CELL2.2	65W	0.3M DV
AS7736Z-433G25Mn	EMEA	South Africa	LX.PJB02.059	AS7736Z-433G25Mn EM W7HP64EMATZA2 MC UMACbck 2G+1G/250/6L2.2/5R/ CB_bgn_0.3D_HG_ES61	PMDT4300	NLED17.3WXGA+G	UMA	N	SO2GBI6/ SO1GBI6	N250GB5.4KS	NSM8XS	5 in 1- Build in	3rd WiFi 1x2 BGN	N	GL40(A1)	ICH9M	6CELL2.2	65W	0.3M DV
AS7736Z-433G25Mn	EMEA	Middle East	LX.PJB02.054	AS7736Z-433G25Mn EM W7HP64EMATME2 MC UMACbck 2G+1G/250/6L2.2/5R/ CB_bgn_0.3D_HG_ES61	PMDT4300	NLED17.3WXGA+G	UMA	N	SO2GBI6/ SO1GBI6	N250GB5.4KS	NSM8XS	5 in 1- Build in	3rd WiFi 1x2 BGN	N	GL40(A1)	ICH9M	6CELL2.2	65W	0.3M DV
AS7736Z-433G25Mn	EMEA	Middle East	LX.PJB02.058	AS7736Z-433G25Mn EM W7HP64EMATME9 MC UMACbck 2G+1G/250/6L2.2/5R/ CB_bgn_0.3D_HG_ES81	PMDT4300	NLED17.3WXGA+G	UMA	N	SO2GBI6/ SO1GBI6	N250GB5.4KS	NSM8XS	5 in 1- Build in	3rd WiFi 1x2 BGN	N	GL40(A1)	ICH9M	6CELL2.2	65W	0.3M DV
AS7736Z-433G25Mn	EMEA	Middle East	LX.PJB02.061	AS7736Z-433G25Mn EM W7HP64EMATME6 MC UMACbck 2G+1G/250/6L2.2/5R/ CB_bgn_0.3D_HG_ES61	PMDT4300	NLED17.3WXGA+G	UMA	N	SO2GBI6/ SO1GBI6	N250GB5.4KS	NSM8XS	5 in 1- Build in	3rd WiFi 1x2 BGN	N	GL40(A1)	ICH9M	6CELL2.2	65W	0.3M DV
AS7736Z-433G25Mn	EMEA	Eastern Europe	LX.PJB02.064	AS7736Z-433G25Mn W7HP64ATEU7 MC UMACbck 2G+1G/250/6L2.2/5R/ CB_bgn_0.3D_HG_SL11	PMDT4300	NLED17.3WXGA+G	UMA	N	SO2GBI6/ SO1GBI6	N250GB5.4KS	NSM8XS	5 in 1- Build in	3rd WiFi 1x2 BGN	N	GL40(A1)	ICH9M	6CELL2.2	65W	0.3M DV
AS7736Z-433G25Mn	EMEA	Eastern Europe	LX.PJB02.065	AS7736Z-433G25Mn W7HP64ATEU7 MC UMACbck 2G+1G/250/6L2.2/5R/ CB_bgn_0.3D_HG_ENQ1	PMDT4300	NLED17.3WXGA+G	UMA	N	SO2GBI6/ SO1GBI6	N250GB5.4KS	NSM8XS	5 in 1- Build in	3rd WiFi 1x2 BGN	N	GL40(A1)	ICH9M	6CELL2.2	65W	0.3M DV
AS7736Z-433G25Mn	EMEA	Middle East	LX.PJB02.063	AS7736Z-433G25Mn EM W7HP64EMATME4 MC UMACbck 2G+1G/250/6L2.2/5R/ CB_bgn_0.3D_HG_ES61	PMDT4300	NLED17.3WXGA+G	UMA	N	SO2GBI6/ SO1GBI6	N250GB5.4KS	NSM8XS	5 in 1- Build in	3rd WiFi 1x2 BGN	N	GL40(A1)	ICH9M	6CELL2.2	65W	0.3M DV
AS7736Z-433G25Mn	EMEA	Middle East	LX.PJB02.062	AS7736Z-433G25Mn EM W7HP64EMATME2 MC UMACbck 2G+1G/250/6L2.2/5R/ CB_bgn_0.3D_HG_AR11	PMDT4300	NLED17.3WXGA+G	UMA	N	SO2GBI6/ SO1GBI6	N250GB5.4KS	NSM8XS	5 in 1- Build in	3rd WiFi 1x2 BGN	N	GL40(A1)	ICH9M	6CELL2.2	65W	0.3M DV
AS7736Z-433G25Mn	EMEA	Cyprus	LX.PJB02.070	AS7736Z-433G25Mn W7HP64ATCY1 MC UMACbck 2G+1G/250/6L2.2/5R/ CB_bgn_0.3D_HG_ES61	PMDT4300	NLED17.3WXGA+G	UMA	N	SO2GBI6/ SO1GBI6	N250GB5.4KS	NSM8XS	5 in 1- Build in	3rd WiFi 1x2 BGN	N	GL40(A1)	ICH9M	6CELL2.2	65W	0.3M DV
AS7736Z-433G25Mn	EMEA	Luxembourg	LX.PJB02.067	AS7736Z-433G25Mn W7HP64ATLU3 MC UMACbck 2G+1G/250/6L2.2/5R/ CB_bgn_0.3D_HG_IT41	PMDT4300	NLED17.3WXGA+G	UMA	N	SO2GBI6/ SO1GBI6	N250GB5.4KS	NSM8XS	5 in 1- Build in	3rd WiFi 1x2 BGN	N	GL40(A1)	ICH9M	6CELL2.2	65W	0.3M DV

AS7736Z-433G25Mn	EMEA	Sweden	LX.PJB02.066	AS7736Z-433G25Mn W7HP64ATSE1 MC UMACbk 2G+1G/250/6L2.2/5R/ CB_bgn_0.3D_HG_F11	PMDT4300	NLED17.3WXGA+G	UMA	N	SO2GBI6/ SO1GBI6	N250GB5.4KS	NSM8XS	5 in 1- Build in	3rd WiFi 1x2 BGN	N	GL40(A1)	ICH9M	6CELL2.2	65W	0.3M DV
AS7736Z-433G25Mn	EMEA	Italy	LX.PJB02.069	AS7736Z-433G25Mn W7HP64ATT1 MC UMACbk 2G+1G/250/6L2.2/5R/ CB_bgn_0.3D_HG_IT11	PMDT4300	NLED17.3WXGA+G	UMA	N	SO2GBI6/ SO1GBI6	N250GB5.4KS	NSM8XS	5 in 1- Build in	3rd WiFi 1x2 BGN	N	GL40(A1)	ICH9M	6CELL2.2	65W	0.3M DV
AS7736Z-433G25Mn	EMEA	Eastern Europe	LX.PJB02.072	AS7736Z-433G25Mn W7HP64ATEU4 MC UMACbk 2G+1G/250/6L2.2/5R/ CB_bgn_0.3D_HG_SV21	PMDT4300	NLED17.3WXGA+G	UMA	N	SO2GBI6/ SO1GBI6	N250GB5.4KS	NSM8XS	5 in 1- Build in	3rd WiFi 1x2 BGN	N	GL40(A1)	ICH9M	6CELL2.2	65W	0.3M DV
AS7736Z-433G25Mn	EMEA	Austria	LX.PJB02.071	AS7736Z-433G25Mn W7HP64AT41 MC UMACbk 2G+1G/250/6L2.2/5R/ CB_bgn_0.3D_HG_DE61	PMDT4300	NLED17.3WXGA+G	UMA	N	SO2GBI6/ SO1GBI6	N250GB5.4KS	NSM8XS	5 in 1- Build in	3rd WiFi 1x2 BGN	N	GL40(A1)	ICH9M	6CELL2.2	65W	0.3M DV
AS7736Z-433G25Mn	EMEA	Czech	LX.PJB02.074	AS7736Z-433G25Mn W7HP64ATCZ2 MC UMACbk 2G+1G/250/6L2.2/5R/ CB_bgn_0.3D_HG_SK11	PMDT4300	NLED17.3WXGA+G	UMA	N	SO2GBI6/ SO1GBI6	N250GB5.4KS	NSM8XS	5 in 1- Build in	3rd WiFi 1x2 BGN	N	GL40(A1)	ICH9M	6CELL2.2	65W	0.3M DV
AS7736Z-433G25Mn	EMEA	Norway	LX.PJB02.073	AS7736Z-433G25Mn W7HP64ATNO1 MC UMACbk 2G+1G/250/6L2.2/5R/ CB_bgn_0.3D_HGO11	PMDT4300	NLED17.3WXGA+G	UMA	N	SO2GBI6/ SO1GBI6	N250GB5.4KS	NSM8XS	5 in 1- Build in	3rd WiFi 1x2 BGN	N	GL40(A1)	ICH9M	6CELL2.2	65W	0.3M DV
AS7736Z-433G25Mn	EMEA	Finland	LX.PJB02.068	AS7736Z-433G25Mn W7HP64ATFI2 MC UMACbk 2G+1G/250/6L2.2/5R/ CB_bgn_0.3D_HG_FI11	PMDT4300	NLED17.3WXGA+G	UMA	N	SO2GBI6/ SO1GBI6	N250GB5.4KS	NSM8XS	5 in 1- Build in	3rd WiFi 1x2 BGN	N	GL40(A1)	ICH9M	6CELL2.2	65W	0.3M DV
AS7736Z-433G25Mn	EMEA	UK	LX.PJB02.075	AS7736Z-433G25Mn W7HP64ATGB1 MC UMACbk 2G+1G/250/6L2.2/5R/ CB_bgn_0.3D_HG_EN11	PMDT4300	NLED17.3WXGA+G	UMA	N	SO2GBI6/ SO1GBI6	N250GB5.4KS	NSM8XS	5 in 1- Build in	3rd WiFi 1x2 BGN	N	GL40(A1)	ICH9M	6CELL2.2	65W	0.3M DV
AS7736Z-433G25Mn	EMEA	France	LX.PJB02.076	AS7736Z-433G25Mn W7HP64ATFR1 MC UMACbk 2G+1G/250/6L2.2/5R/ CB_bgn_0.3D_HG_FR21	PMDT4300	NLED17.3WXGA+G	UMA	N	SO2GBI6/ SO1GBI6	N250GB5.4KS	NSM8XS	5 in 1- Build in	3rd WiFi 1x2 BGN	N	GL40(A1)	ICH9M	6CELL2.2	65W	0.3M DV
AS7736Z-433G25Mn	EMEA	Norway	LX.PJB02.077	AS7736Z-433G25Mn W7HP64ATNO3 MC UMACbk 2G+1G/250/6L2.2/5R/ CB_bgn_0.3D_HG_ENS1	PMDT4300	NLED17.3WXGA+G	UMA	N	SO2GBI6/ SO1GBI6	N250GB5.4KS	NSM8XS	5 in 1- Build in	3rd WiFi 1x2 BGN	N	GL40(A1)	ICH9M	6CELL2.2	65W	0.3M DV
AS7736Z-433G25Mn	EMEA	Germany	LX.PJB02.080	AS7736Z-433G25Mn W7HP64ATDE1 MC UMACbk 2G+1G/250/6L2.2/5R/ CB_bgn_0.3D_HG_DE11	PMDT4300	NLED17.3WXGA+G	UMA	N	SO2GBI6/ SO1GBI6	N250GB5.4KS	NSM8XS	5 in 1- Build in	3rd WiFi 1x2 BGN	N	GL40(A1)	ICH9M	6CELL2.2	65W	0.3M DV
AS7736Z-433G25Mn	EMEA	Denmark	LX.PJB02.078	AS7736Z-433G25Mn W7HP64ATDK2 MC UMACbk 2G+1G/250/6L2.2/5R/ CB_bgn_0.3D_HG_ENS1	PMDT4300	NLED17.3WXGA+G	UMA	N	SO2GBI6/ SO1GBI6	N250GB5.4KS	NSM8XS	5 in 1- Build in	3rd WiFi 1x2 BGN	N	GL40(A1)	ICH9M	6CELL2.2	65W	0.3M DV
AS7736Z-433G25Mn	EMEA	Portugal	LX.PJB02.079	AS7736Z-433G25Mn W7HP64ATPT1 MC UMACbk 2G+1G/250/6L2.2/5R/ CB_bgn_0.3D_HG_PT11	PMDT4300	NLED17.3WXGA+G	UMA	N	SO2GBI6/ SO1GBI6	N250GB5.4KS	NSM8XS	5 in 1- Build in	3rd WiFi 1x2 BGN	N	GL40(A1)	ICH9M	6CELL2.2	65W	0.3M DV
AS7736Z-433G25Mn	EMEA	Hungary	LX.PJB02.083	AS7736Z-433G25Mn W7HP64ATHU1 MC UMACbk 2G+1G/250/6L2.2/5R/ CB_bgn_0.3D_HG_HU11	PMDT4300	NLED17.3WXGA+G	UMA	N	SO2GBI6/ SO1GBI6	N250GB5.4KS	NSM8XS	5 in 1- Build in	3rd WiFi 1x2 BGN	N	GL40(A1)	ICH9M	6CELL2.2	65W	0.3M DV
AS7736Z-433G25Mn	EMEA	Denmark	LX.PJB02.082	AS7736Z-433G25Mn W7HP64ATDK1 MC UMACbk 2G+1G/250/6L2.2/5R/ CB_bgn_0.3D_HGO11	PMDT4300	NLED17.3WXGA+G	UMA	N	SO2GBI6/ SO1GBI6	N250GB5.4KS	NSM8XS	5 in 1- Build in	3rd WiFi 1x2 BGN	N	GL40(A1)	ICH9M	6CELL2.2	65W	0.3M DV
AS7736Z-433G25Mn	EMEA	Eastern Europe	LX.PJB02.081	AS7736Z-433G25Mn W7HP64ATEU5 MC UMACbk 2G+1G/250/6L2.2/5R/ CB_bgn_0.3D_HG_RO11	PMDT4300	NLED17.3WXGA+G	UMA	N	SO2GBI6/ SO1GBI6	N250GB5.4KS	NSM8XS	5 in 1- Build in	3rd WiFi 1x2 BGN	N	GL40(A1)	ICH9M	6CELL2.2	65W	0.3M DV
AS7736Z-433G25Mn	EMEA	Spain	LX.PJB02.084	AS7736Z-433G25Mn W7HP64ATES1 MC UMACbk 2G+1G/250/6L2.2/5R/ CB_bgn_0.3D_HG_ES51	PMDT4300	NLED17.3WXGA+G	UMA	N	SO2GBI6/ SO1GBI6	N250GB5.4KS	NSM8XS	5 in 1- Build in	3rd WiFi 1x2 BGN	N	GL40(A1)	ICH9M	6CELL2.2	65W	0.3M DV
AS7736Z-434G32Mn	EMEA	Spain	LX.PJB02.048	AS7736Z-434G32Mn W7HP64ATES1 MC UMACbk 2*2G/320/6L2.2/5R/ CB_bgn_0.3D_HG_ES51	PMDT4300	NLED17.3WXGA+G	UMA	N	SO2GBI6/ SO1GBI6	N320GB5.4KS	NSM8XS	5 in 1- Build in	3rd WiFi 1x2 BGN	N	GL40(A1)	ICH9M	6CELL2.2	65W	0.3M DV
AS7736Z-433G25Mn	EMEA	Belgium	LX.PJB02.086	AS7736Z-433G25Mn W7HP64ATBE1 MC UMACbk 2G+1G/250/6L2.2/5R/ CB_bgn_0.3D_HGL11	PMDT4300	NLED17.3WXGA+G	UMA	N	SO2GBI6/ SO1GBI6	N250GB5.4KS	NSM8XS	5 in 1- Build in	3rd WiFi 1x2 BGN	N	GL40(A1)	ICH9M	6CELL2.2	65W	0.3M DV
AS7736Z-433G25Mn	EMEA	Greece	LX.PJB02.087	AS7736Z-433G25Mn W7HP64ATGR1 MC UMACbk 2G+1G/250/6L2.2/5R/ CB_bgn_0.3D_HG_EL31	PMDT4300	NLED17.3WXGA+G	UMA	N	SO2GBI6/ SO1GBI6	N250GB5.4KS	NSM8XS	5 in 1- Build in	3rd WiFi 1x2 BGN	N	GL40(A1)	ICH9M	6CELL2.2	65W	0.3M DV
AS7736Z-433G25Mn	EMEA	Poland	LX.PJB02.085	AS7736Z-433G25Mn W7HP64ATPL1 MC UMACbk 2G+1G/250/6L2.2/5R/ CB_bgn_0.3D_HG_PL11	PMDT4300	NLED17.3WXGA+G	UMA	N	SO2GBI6/ SO1GBI6	N250GB5.4KS	NSM8XS	5 in 1- Build in	3rd WiFi 1x2 BGN	N	GL40(A1)	ICH9M	6CELL2.2	65W	0.3M DV



AS7736Z-433G25Mn	EMEA	Holland	LX.PJB02.090	AS7736Z-433G25Mn W7HP64ATNL1 MC UMACbk 2G+1G/250/6L2.2/5R/ CB_bgn_0.3D_HGL11	PMDT4300	NLED17.3WXGA+G	UMA	N	SO2GBI6/ SO1GBI6	N250GB5.4KS	NSM8XS	5 in 1-Build in	3rd WiFi 1x2 BGN	N	GL40(A1)	ICH9M	6CELL2.2	65W	0.3M DV
AS7736Z-433G25Mn	EMEA	Switzerland	LX.PJB02.089	AS7736Z-433G25Mn W7HP64ATCH1 MC UMACbk 2G+1G/250/6L2.2/5R/ CB_bgn_0.3D_HG_IT41	PMDT4300	NLED17.3WXGA+G	UMA	N	SO2GBI6/ SO1GBI6	N250GB5.4KS	NSM8XS	5 in 1-Build in	3rd WiFi 1x2 BGN	N	GL40(A1)	ICH9M	6CELL2.2	65W	0.3M DV
AS7736Z-433G25Mn	EMEA	Eastern Europe	LX.PJB02.088	AS7736Z-433G25Mn W7HP64ATEU5 MC UMACbk 2G+1G/250/6L2.2/5R/ CB_bgn_0.3D_HG_PL71	PMDT4300	NLED17.3WXGA+G	UMA	N	SO2GBI6/ SO1GBI6	N250GB5.4KS	NSM8XS	5 in 1-Build in	3rd WiFi 1x2 BGN	N	GL40(A1)	ICH9M	6CELL2.2	65W	0.3M DV
AS7736Z-434G32Mn	PA	Canada	LX.PJB02.047	AS7736Z-434G32Mn W7HP64ATCA2 MC UMACbk 2+2G/320/6L2.2/5R/ CB_bgn_0.3D_HG_FR81	PMDT4300	NLED17.3WXGA+G	UMA	N	SO2GBI6/ SO1GBI6	N320GB5.4KS	NSM8XS	5 in 1-Build in	3rd WiFi 1x2 BGN	N	GL40(A1)	ICH9M	6CELL2.2	65W	0.3M DV
AS7736Z-433G32Mn	EMEA	Israel	LX.PJB02.002	AS7736Z-433G32Mn W7HP64ATL1 MC UMACbk 2G+1G/320/6L2.2/5R/ CB_bgn_0.3D_HG_HE31	PMDT4300	NLED17.3WXGA+G	UMA	N	SO2GBI6/ SO1GBI6	N320GB5.4KS	NSM8XS	5 in 1-Build in	3rd WiFi 1x2 BGN	N	GL40(A1)	ICH9M	6CELL2.2	65W	0.3M DV
AS7736Z-433G32Mn	EMEA	Serbia/ Macedonia	LX.PJB02.001	AS7736Z-433G32Mn EM W7HP64ATCS1 MC UMACbk 2G+1G/320/6L2.2/5R/ CB_bgn_0.3D_HG_SL11	PMDT4300	NLED17.3WXGA+G	UMA	N	SO2GBI6/ SO1GBI6	N320GB5.4KS	NSM8XS	5 in 1-Build in	3rd WiFi 1x2 BGN	N	GL40(A1)	ICH9M	6CELL2.2	65W	0.3M DV
AS7736Z-433G32Mn	EMEA	Israel	LX.PJB02.003	AS7736Z-433G32Mn W7HP64ATL1 MC UMACbk 2G+1G/320/6L2.2/5R/ CB_bgn_0.3D_HG_HE11	PMDT4300	NLED17.3WXGA+G	UMA	N	SO2GBI6/ SO1GBI6	N320GB5.4KS	NSM8XS	5 in 1-Build in	3rd WiFi 1x2 BGN	N	GL40(A1)	ICH9M	6CELL2.2	65W	0.3M DV
AS7736Z-433G32Mn	EMEA	Middle East	LX.PJB02.006	AS7736Z-433G32Mn EM W7HP64EMATME4 MC UMACbk 2G+1G/320/6L2.2/5R/ CB_bgn_0.3D_HG_RU61	PMDT4300	NLED17.3WXGA+G	UMA	N	SO2GBI6/ SO1GBI6	N320GB5.4KS	NSM8XS	5 in 1-Build in	3rd WiFi 1x2 BGN	N	GL40(A1)	ICH9M	6CELL2.2	65W	0.3M DV
AS7736Z-433G32Mn	EMEA	South Africa	LX.PJB02.005	AS7736Z-433G32Mn EM W7HP64EMATZA1 MC UMACbk 2G+1G/320/6L2.2/5R/ CB_bgn_0.3D_HG_ES81	PMDT4300	NLED17.3WXGA+G	UMA	N	SO2GBI6/ SO1GBI6	N320GB5.4KS	NSM8XS	5 in 1-Build in	3rd WiFi 1x2 BGN	N	GL40(A1)	ICH9M	6CELL2.2	65W	0.3M DV
AS7736Z-433G32Mn	EMEA	Algeria	LX.PJB02.004	AS7736Z-433G32Mn EM W7HP64EMATDZ1 MC UMACbk 2G+1G/320/6L2.2/5R/ CB_bgn_0.3D_HG_ES81	PMDT4300	NLED17.3WXGA+G	UMA	N	SO2GBI6/ SO1GBI6	N320GB5.4KS	NSM8XS	5 in 1-Build in	3rd WiFi 1x2 BGN	N	GL40(A1)	ICH9M	6CELL2.2	65W	0.3M DV
AS7736Z-433G32Mn	EMEA	Middle East	LX.PJB02.007	AS7736Z-433G32Mn EM W7HP64EMATME2 MC UMACbk 2G+1G/320/6L2.2/5R/ CB_bgn_0.3D_HG_ES61	PMDT4300	NLED17.3WXGA+G	UMA	N	SO2GBI6/ SO1GBI6	N320GB5.4KS	NSM8XS	5 in 1-Build in	3rd WiFi 1x2 BGN	N	GL40(A1)	ICH9M	6CELL2.2	65W	0.3M DV
AS7736Z-433G32Mn	EMEA	South Africa	LX.PJB02.013	AS7736Z-433G32Mn EM W7HP64EMATZA4 MC UMACbk 2G+1G/320/6L2.2/5R/ CB_bgn_0.3D_HG_ES61	PMDT4300	NLED17.3WXGA+G	UMA	N	SO2GBI6/ SO1GBI6	N320GB5.4KS	NSM8XS	5 in 1-Build in	3rd WiFi 1x2 BGN	N	GL40(A1)	ICH9M	6CELL2.2	65W	0.3M DV
AS7736Z-433G32Mn	EMEA	Middle East	LX.PJB02.012	AS7736Z-433G32Mn EM W7HP64EMATME3 MC UMACbk 2G+1G/320/6L2.2/5R/ CB_bgn_0.3D_HG_ES81	PMDT4300	NLED17.3WXGA+G	UMA	N	SO2GBI6/ SO1GBI6	N320GB5.4KS	NSM8XS	5 in 1-Build in	3rd WiFi 1x2 BGN	N	GL40(A1)	ICH9M	6CELL2.2	65W	0.3M DV
AS7736Z-433G32Mn	EMEA	Middle East	LX.PJB02.015	AS7736Z-433G32Mn EM W7HP64EMATME2 MC UMACbk 2G+1G/320/6L2.2/5R/ CB_bgn_0.3D_HG_AR11	PMDT4300	NLED17.3WXGA+G	UMA	N	SO2GBI6/ SO1GBI6	N320GB5.4KS	NSM8XS	5 in 1-Build in	3rd WiFi 1x2 BGN	N	GL40(A1)	ICH9M	6CELL2.2	65W	0.3M DV
AS7736Z-433G32Mn	EMEA	Middle East	LX.PJB02.010	AS7736Z-433G32Mn EM W7HP64EMATME9 MC UMACbk 2G+1G/320/6L2.2/5R/ CB_bgn_0.3D_HG_ES81	PMDT4300	NLED17.3WXGA+G	UMA	N	SO2GBI6/ SO1GBI6	N320GB5.4KS	NSM8XS	5 in 1-Build in	3rd WiFi 1x2 BGN	N	GL40(A1)	ICH9M	6CELL2.2	65W	0.3M DV
AS7736Z-433G32Mn	EMEA	Middle East	LX.PJB02.014	AS7736Z-433G32Mn EM W7HP64EMATME4 MC UMACbk 2G+1G/320/6L2.2/5R/ CB_bgn_0.3D_HG_ES61	PMDT4300	NLED17.3WXGA+G	UMA	N	SO2GBI6/ SO1GBI6	N320GB5.4KS	NSM8XS	5 in 1-Build in	3rd WiFi 1x2 BGN	N	GL40(A1)	ICH9M	6CELL2.2	65W	0.3M DV
AS7736Z-433G32Mn	EMEA	Turkey	LX.PJB02.009	AS7736Z-433G32Mn EM W7HP64EMATTR1 MC UMACbk 2G+1G/320/6L2.2/5R/ CB_bgn_0.3D_HG_TR31	PMDT4300	NLED17.3WXGA+G	UMA	N	SO2GBI6/ SO1GBI6	N320GB5.4KS	NSM8XS	5 in 1-Build in	3rd WiFi 1x2 BGN	N	GL40(A1)	ICH9M	6CELL2.2	65W	0.3M DV
AS7736Z-433G32Mn	EMEA	South Africa	LX.PJB02.011	AS7736Z-433G32Mn EM W7HP64EMATZA2 MC UMACbk 2G+1G/320/6L2.2/5R/ CB_bgn_0.3D_HG_ES61	PMDT4300	NLED17.3WXGA+G	UMA	N	SO2GBI6/ SO1GBI6	N320GB5.4KS	NSM8XS	5 in 1-Build in	3rd WiFi 1x2 BGN	N	GL40(A1)	ICH9M	6CELL2.2	65W	0.3M DV

AS7736Z-433G32Mn	EMEA	Ukraine	LX.PJB02.018	AS7736Z-433G32Mn W7HP64RUATUK1 MC UMACbk 2G+1G/320/6L2.2/5R/ CB_bgn_0.3D_HG_RU61	PMDT4300	NLED17.3WXGA+G	UMA	N	SO2GBI6/ SO1GBI6	N320GB5.4KS	NSM8XS	5 in 1- Build in	3rd WiFi 1x2 BGN	N	GL40(A1)	ICH9M	6CELL2.2	65W	0.3M DV
AS7736Z-433G32Mi	EMEA	Russia	LX.PJB02.017	AS7736Z-433G32Mi W7HP64RUATRU1 MC UMACbk 2G+1G/320/6L2.2/5R/ CB_bgn_0.3D_HG_RU11	PMDT4300	NLED17.3WXGA+G	UMA	N	SO2GBI6/ SO1GBI6	N320GB5.4KS	NSM8XS	5 in 1- Build in	3rd WiFi BG	N	GL40(A1)	ICH9M	6CELL2.2	65W	0.3M DV
AS7736Z-433G32Mn	EMEA	Middle East	LX.PJB02.016	AS7736Z-433G32Mn EM W7HP64EMAT6E6 MC UMACbk 2G+1G/320/6L2.2/5R/ CB_bgn_0.3D_HG_ES61	PMDT4300	NLED17.3WXGA+G	UMA	N	SO2GBI6/ SO1GBI6	N320GB5.4KS	NSM8XS	5 in 1- Build in	3rd WiFi 1x2 BGN	N	GL40(A1)	ICH9M	6CELL2.2	65W	0.3M DV
AS7736Z-433G32Mn	EMEA	Cyprus	LX.PJB02.020	AS7736Z-433G32Mn W7HP64ATCY1 MC UMACbk 2G+1G/320/6L2.2/5R/ CB_bgn_0.3D_HG_ES61	PMDT4300	NLED17.3WXGA+G	UMA	N	SO2GBI6/ SO1GBI6	N320GB5.4KS	NSM8XS	5 in 1- Build in	3rd WiFi 1x2 BGN	N	GL40(A1)	ICH9M	6CELL2.2	65W	0.3M DV
AS7736Z-433G32Mn	EMEA	Sweden	LX.PJB02.024	AS7736Z-433G32Mn W7HP64ATSE1 MC UMACbk 2G+1G/320/6L2.2/5R/ CB_bgn_0.3D_HG_F11	PMDT4300	NLED17.3WXGA+G	UMA	N	SO2GBI6/ SO1GBI6	N320GB5.4KS	NSM8XS	5 in 1- Build in	3rd WiFi 1x2 BGN	N	GL40(A1)	ICH9M	6CELL2.2	65W	0.3M DV
AS7736Z-433G32Mn	EMEA	Luxembourg	LX.PJB02.022	AS7736Z-433G32Mn W7HP64ATLU3 MC UMACbk 2G+1G/320/6L2.2/5R/ CB_bgn_0.3D_HG_IT41	PMDT4300	NLED17.3WXGA+G	UMA	N	SO2GBI6/ SO1GBI6	N320GB5.4KS	NSM8XS	5 in 1- Build in	3rd WiFi 1x2 BGN	N	GL40(A1)	ICH9M	6CELL2.2	65W	0.3M DV
AS7736Z-433G32Mn	EMEA	Eastern Europe	LX.PJB02.023	AS7736Z-433G32Mn W7HP64ATEU7 MC UMACbk 2G+1G/320/6L2.2/5R/ CB_bgn_0.3D_HG_ENQ1	PMDT4300	NLED17.3WXGA+G	UMA	N	SO2GBI6/ SO1GBI6	N320GB5.4KS	NSM8XS	5 in 1- Build in	3rd WiFi 1x2 BGN	N	GL40(A1)	ICH9M	6CELL2.2	65W	0.3M DV
AS7736Z-433G32Mn	EMEA	Eastern Europe	LX.PJB02.019	AS7736Z-433G32Mn W7HP64ATEU7 MC UMACbk 2G+1G/320/6L2.2/5R/ CB_bgn_0.3D_HG_SL11	PMDT4300	NLED17.3WXGA+G	UMA	N	SO2GBI6/ SO1GBI6	N320GB5.4KS	NSM8XS	5 in 1- Build in	3rd WiFi 1x2 BGN	N	GL40(A1)	ICH9M	6CELL2.2	65W	0.3M DV
AS7736Z-433G32Mn	EMEA	Finland	LX.PJB02.025	AS7736Z-433G32Mn W7HP64ATFI2 MC UMACbk 2G+1G/320/6L2.2/5R/ CB_bgn_0.3D_HG_F11	PMDT4300	NLED17.3WXGA+G	UMA	N	SO2GBI6/ SO1GBI6	N320GB5.4KS	NSM8XS	5 in 1- Build in	3rd WiFi 1x2 BGN	N	GL40(A1)	ICH9M	6CELL2.2	65W	0.3M DV
AS7736Z-433G32Mn	EMEA	Italy	LX.PJB02.021	AS7736Z-433G32Mn W7HP64ATT1 MC UMACbk 2G+1G/320/6L2.2/5R/ CB_bgn_0.3D_HG_IT11	PMDT4300	NLED17.3WXGA+G	UMA	N	SO2GBI6/ SO1GBI6	N320GB5.4KS	NSM8XS	5 in 1- Build in	3rd WiFi 1x2 BGN	N	GL40(A1)	ICH9M	6CELL2.2	65W	0.3M DV
AS7736Z-433G32Mn	EMEA	UK	LX.PJB02.033	AS7736Z-433G32Mn W7HP64ATGB1 MC UMACbk 2G+1G/320/6L2.2/5R/ CB_bgn_0.3D_HG_EN11	PMDT4300	NLED17.3WXGA+G	UMA	N	SO2GBI6/ SO1GBI6	N320GB5.4KS	NSM8XS	5 in 1- Build in	3rd WiFi 1x2 BGN	N	GL40(A1)	ICH9M	6CELL2.2	65W	0.3M DV
AS7736Z-433G32Mn	EMEA	Austria	LX.PJB02.028	AS7736Z-433G32Mn W7HP64ATAT1 MC UMACbk 2G+1G/320/6L2.2/5R/ CB_bgn_0.3D_HG_DE61	PMDT4300	NLED17.3WXGA+G	UMA	N	SO2GBI6/ SO1GBI6	N320GB5.4KS	NSM8XS	5 in 1- Build in	3rd WiFi 1x2 BGN	N	GL40(A1)	ICH9M	6CELL2.2	65W	0.3M DV
AS7736Z-433G32Mn	EMEA	Eastern Europe	LX.PJB02.034	AS7736Z-433G32Mn W7HP64ATEU4 MC UMACbk 2G+1G/320/6L2.2/5R/ CB_bgn_0.3D_HG_SV21	PMDT4300	NLED17.3WXGA+G	UMA	N	SO2GBI6/ SO1GBI6	N320GB5.4KS	NSM8XS	5 in 1- Build in	3rd WiFi 1x2 BGN	N	GL40(A1)	ICH9M	6CELL2.2	65W	0.3M DV
AS7736Z-433G32Mn	EMEA	Norway	LX.PJB02.027	AS7736Z-433G32Mn W7HP64ATNO1 MC UMACbk 2G+1G/320/6L2.2/5R/ CB_bgn_0.3D_HG_NO11	PMDT4300	NLED17.3WXGA+G	UMA	N	SO2GBI6/ SO1GBI6	N320GB5.4KS	NSM8XS	5 in 1- Build in	3rd WiFi 1x2 BGN	N	GL40(A1)	ICH9M	6CELL2.2	65W	0.3M DV
AS7736Z-433G32Mn	EMEA	France	LX.PJB02.029	AS7736Z-433G32Mn W7HP64ATFR1 MC UMACbk 2G+1G/320/6L2.2/5R/ CB_bgn_0.3D_HG_FR21	PMDT4300	NLED17.3WXGA+G	UMA	N	SO2GBI6/ SO1GBI6	N320GB5.4KS	NSM8XS	5 in 1- Build in	3rd WiFi 1x2 BGN	N	GL40(A1)	ICH9M	6CELL2.2	65W	0.3M DV
AS7736Z-433G32Mn	EMEA	Czech	LX.PJB02.026	AS7736Z-433G32Mn W7HP64ATCZ2 MC UMACbk 2G+1G/320/6L2.2/5R/ CB_bgn_0.3D_HG_SK11	PMDT4300	NLED17.3WXGA+G	UMA	N	SO2GBI6/ SO1GBI6	N320GB5.4KS	NSM8XS	5 in 1- Build in	3rd WiFi 1x2 BGN	N	GL40(A1)	ICH9M	6CELL2.2	65W	0.3M DV
AS7736Z-433G32Mn	EMEA	Norway	LX.PJB02.032	AS7736Z-433G32Mn W7HP64ATNO3 MC UMACbk 2G+1G/320/6L2.2/5R/ CB_bgn_0.3D_HG_ENS1	PMDT4300	NLED17.3WXGA+G	UMA	N	SO2GBI6/ SO1GBI6	N320GB5.4KS	NSM8XS	5 in 1- Build in	3rd WiFi 1x2 BGN	N	GL40(A1)	ICH9M	6CELL2.2	65W	0.3M DV
AS7736Z-433G32Mn	EMEA	Germany	LX.PJB02.030	AS7736Z-433G32Mn W7HP64ATDE1 MC UMACbk 2G+1G/320/6L2.2/5R/ CB_bgn_0.3D_HG_DE11	PMDT4300	NLED17.3WXGA+G	UMA	N	SO2GBI6/ SO1GBI6	N320GB5.4KS	NSM8XS	5 in 1- Build in	3rd WiFi 1x2 BGN	N	GL40(A1)	ICH9M	6CELL2.2	65W	0.3M DV
AS7736Z-433G32Mn	EMEA	Portugal	LX.PJB02.031	AS7736Z-433G32Mn W7HP64ATPT1 MC UMACbk 2G+1G/320/6L2.2/5R/ CB_bgn_0.3D_HG_PT11	PMDT4300	NLED17.3WXGA+G	UMA	N	SO2GBI6/ SO1GBI6	N320GB5.4KS	NSM8XS	5 in 1- Build in	3rd WiFi 1x2 BGN	N	GL40(A1)	ICH9M	6CELL2.2	65W	0.3M DV
AS7736Z-433G32Mn	EMEA	Denmark	LX.PJB02.035	AS7736Z-433G32Mn W7HP64ATDK2 MC UMACbk 2G+1G/320/6L2.2/5R/ CB_bgn_0.3D_HG_ENS1	PMDT4300	NLED17.3WXGA+G	UMA	N	SO2GBI6/ SO1GBI6	N320GB5.4KS	NSM8XS	5 in 1- Build in	3rd WiFi 1x2 BGN	N	GL40(A1)	ICH9M	6CELL2.2	65W	0.3M DV

AS7736Z-433G32Mn	EMEA	Denmark	LX.PJB02.044	AS7736Z-433G32Mn W7HP64ATDK1 MC UMACbk 2G+1G/320/6L2.2/5R/ CB_bgn_0_3D_HG_N011	PMDT4300	NLED17.3WXGA+G	UMA	N	SO2GBI16/ SO1GBI16	N320GB5.4KS	NSM8XS	5 in 1- Build in	3rd WiFi 1x2 BGN	N	GL40(A1)	ICH9M	6CELL2.2	65W	0.3M DV
AS7736Z-433G32Mn	EMEA	Hungary	LX.PJB02.037	AS7736Z-433G32Mn W7HP64ATHU1 MC UMACbk 2G+1G/320/6L2.2/5R/ CB_bgn_0_3D_HG_HU11	PMDT4300	NLED17.3WXGA+G	UMA	N	SO2GBI16/ SO1GBI16	N320GB5.4KS	NSM8XS	5 in 1- Build in	3rd WiFi 1x2 BGN	N	GL40(A1)	ICH9M	6CELL2.2	65W	0.3M DV
AS7736Z-442G32Mn	WW	WW	S2.PJB02.002	AS7736Z-442G32Mn W7HP64AWW1 MC UMACbk 2*1G/320/6L2.2/5R/ CB_bgn_0_3D_BT_ES62	PMDT4400	NLED17.3WXGA+G	UMA	N	SO1GBI16	N320GB5.4KS	NSM8XS	5 in 1- Build in	3rd WiFi 1x2 BGN	BT 2.1/N	GL40(A1)	ICH9M	6CELL2.2	65W	0.3M DV
AS7736Z-442G32Mn	WW	GCTWN	S2.PJB02.001	AS7736Z-442G32Mn W7HP64AWW1 MC UMACbk 2*1G/320/6L2.2/5R/ CB_bgn_0_3D_HG_ES61	PMDT4400	NLED17.3WXGA+G	UMA	N	SO1GBI16	N320GB5.4KS	NSM8XS	5 in 1- Build in	3rd WiFi 1x2 BGN	BT 2.1/N	GL40(A1)	ICH9M	6CELL2.2	65W	0.3M DV
AS7736Z-433G32Mn	EMEA	Belgium	LX.PJB02.039	AS7736Z-433G32Mn W7HP64ATBE1 MC UMACbk 2G+1G/320/6L2.2/5R/ CB_bgn_0_3D_HG_NL11	PMDT4300	NLED17.3WXGA+G	UMA	N	SO2GBI16/ SO1GBI16	N320GB5.4KS	NSM8XS	5 in 1- Build in	3rd WiFi 1x2 BGN	N	GL40(A1)	ICH9M	6CELL2.2	65W	0.3M DV
AS7736Z-433G32Mn	EMEA	Eastern Europe	LX.PJB02.038	AS7736Z-433G32Mn W7HP64ATEU5 MC UMACbk 2G+1G/320/6L2.2/5R/ CB_bgn_0_3D_HG_RO11	PMDT4300	NLED17.3WXGA+G	UMA	N	SO2GBI16/ SO1GBI16	N320GB5.4KS	NSM8XS	5 in 1- Build in	3rd WiFi 1x2 BGN	N	GL40(A1)	ICH9M	6CELL2.2	65W	0.3M DV
AS7736Z-433G32Mn	EMEA	Greece	LX.PJB02.042	AS7736Z-433G32Mn W7HP64ATGR1 MC UMACbk 2G+1G/320/6L2.2/5R/ CB_bgn_0_3D_HG_EL31	PMDT4300	NLED17.3WXGA+G	UMA	N	SO2GBI16/ SO1GBI16	N320GB5.4KS	NSM8XS	5 in 1- Build in	3rd WiFi 1x2 BGN	N	GL40(A1)	ICH9M	6CELL2.2	65W	0.3M DV
AS7736Z-433G32Mn	EMEA	Poland	LX.PJB02.043	AS7736Z-433G32Mn W7HP64ATPL1 MC UMACbk 2G+1G/320/6L2.2/5R/ CB_bgn_0_3D_HG_PL11	PMDT4300	NLED17.3WXGA+G	UMA	N	SO2GBI16/ SO1GBI16	N320GB5.4KS	NSM8XS	5 in 1- Build in	3rd WiFi 1x2 BGN	N	GL40(A1)	ICH9M	6CELL2.2	65W	0.3M DV
AS7736Z-433G32Mn	EMEA	Holland	LX.PJB02.040	AS7736Z-433G32Mn W7HP64ATNL1 MC UMACbk 2G+1G/320/6L2.2/5R/ CB_bgn_0_3D_HG_NL11	PMDT4300	NLED17.3WXGA+G	UMA	N	SO2GBI16/ SO1GBI16	N320GB5.4KS	NSM8XS	5 in 1- Build in	3rd WiFi 1x2 BGN	N	GL40(A1)	ICH9M	6CELL2.2	65W	0.3M DV
AS7736Z-433G32Mn	EMEA	Switzerland	LX.PJB02.041	AS7736Z-433G32Mn W7HP64ATCH1 MC UMACbk 2G+1G/320/6L2.2/5R/ CB_bgn_0_3D_HG_IT41	PMDT4300	NLED17.3WXGA+G	UMA	N	SO2GBI16/ SO1GBI16	N320GB5.4KS	NSM8XS	5 in 1- Build in	3rd WiFi 1x2 BGN	N	GL40(A1)	ICH9M	6CELL2.2	65W	0.3M DV
AS7736Z-433G32Mn	EMEA	Eastern Europe	LX.PJB02.045	AS7736Z-433G32Mn W7HP64ATEU5 MC UMACbk 2G+1G/320/6L2.2/5R/ CB_bgn_0_3D_HG_PL71	PMDT4300	NLED17.3WXGA+G	UMA	N	SO2GBI16/ SO1GBI16	N320GB5.4KS	NSM8XS	5 in 1- Build in	3rd WiFi 1x2 BGN	N	GL40(A1)	ICH9M	6CELL2.2	65W	0.3M DV
AS7736Z-434G32Mn	PA	USA	LX.PJB02.094	AS7736Z-434G32Mn W7HP64ATUS1 MC UMACbk 2*2G/320/6L2.2/5R/ CB_bgn_0_3D_HG_FRB3	PMDT4300	NLED17.3WXGA+G	UMA	N	SO2GBI16	N320GB5.4KS	NSM8XS	5 in 1- Build in	3rd WiFi 1x2 BGN	N	GL40(A1)	ICH9M	6CELL2.2	65W	0.3M DV
AS7736Z-434G32Mn	PA	USA	LX.PJB02.095	AS7736Z-434G32Mn W7HP64ATUS1 MC UMACbk 2*2G/320/6L2.2/5R/ CB_bgn_0_3D_HG_FRB2	PMDT4300	NLED17.3WXGA+G	UMA	N	SO2GBI16	N320GB5.4KS	NSM8XS	5 in 1- Build in	3rd WiFi 1x2 BGN	N	GL40(A1)	ICH9M	6CELL2.2	65W	0.3M DV
AS7736Z-433G25Mn	EMEA	Hungary	LX.PJB0C.003	AS7736Z-433G25Mn LINPUSAHU1 UMACbk 2G+1G/250/6L2.2/5R/ CB_bgn_0_3D_HG_EN41	PMDT4300	NLED17.3WXGA+G	UMA	N	SO2GBI16/ SO1GBI16	N250GB5.4KS	NSM8XS	5 in 1- Build in	3rd WiFi 1x2 BGN	N	GL40(A1)	ICH9M	6CELL2.2	65W	0.3M DV
AS7736Z-433G50Mn	EMEA	Latvia	LX.PJB0C.002	AS7736Z-433G50Mn LINPUSALV1 UMACbk 2G+1G/500_L/6L2.2/5R/ CB_bgn_0_3D_HG_EN71	PMDT4300	NLED17.3WXGA+G	UMA	N	SO2GBI16/ SO1GBI16	N500GB5.4KS	NSM8XS	5 in 1- Build in	3rd WiFi 1x2 BGN	BT 2.1/N	GL40(A1)	ICH9M	6CELL2.2	65W	0.3M DV
AS7736Z-433G50Mn	EMEA	Eastern Europe	LX.PJB0C.001	AS7736Z-433G50Mn LINPUSAEU5 UMACbk 2G+1G/500_L/6L2.2/5R/ CB_bgn_0_3D_HG_ENF1	PMDT4300	NLED17.3WXGA+G	UMA	N	SO2GBI16/ SO1GBI16	N500GB5.4KS	NSM8XS	5 in 1- Build in	3rd WiFi 1x2 BGN	BT 2.1/N	GL40(A1)	ICH9M	6CELL2.2	65W	0.3M DV
AS7736-664G32Mn	PA	Canada	LX.PHZ02.008	AS7736-664G32Mn W7HP64ATCA2 MC UMACbk 2*2G/320/6L2.2/5R/ CB_n2_0_3D_HG_FR81	C2DT6600	NLED17.3WXGA+G	UMA	N	SO2GBI16	N320GB5.4KS	NSM8XS	5 in 1- Build in	SP1x2MMW	N	GM45	ICH9M	6CELL2.2	65W	0.3M DV
AS7736-664G50Mn	PA	USA	LX.PHZ02.007	AS7736-664G50Mn W7HP64ATUS1 MC UMACbk 2*2G/500_L/6L2.2/5R/ CB_n2_0_3D_HG_FRB3	C2DT6600	NLED17.3WXGA+G	UMA	N	SO2GBI16	N500GB5.4KS	NSM8XS	5 in 1- Build in	SP1x2MMW	N	GM45	ICH9M	6CELL2.2	65W	0.3M DV
AS7736-664G50Mn	PA	USA	LX.PHZ02.005	AS7736-664G50Mn W7HP64ATUS1 MC UMACbk 2*2G/500_L/6L2.2/5R/ CB_n2_0_3D_HG_FRB1	C2DT6600	NLED17.3WXGA+G	UMA	N	SO2GBI16	N500GB5.4KS	NSM8XS	5 in 1- Build in	SP1x2MMW	N	GM45	ICH9M	6CELL2.2	65W	0.3M DV
AS7736-664G50Mn	PA	USA	LX.PHZ02.006	AS7736-664G50Mn W7HP64ATUS1 MC UMACbk 2*2G/500_L/6L2.2/5R/ CB_n2_0_3D_HG_FRB2	C2DT6600	NLED17.3WXGA+G	UMA	N	SO2GBI16	N500GB5.4KS	NSM8XS	5 in 1- Build in	SP1x2MMW	N	GM45	ICH9M	6CELL2.2	65W	0.3M DV
AS7736-664G50Mn	PA	Canada	LX.PHZ02.004	AS7736-664G50Mn W7HP64ATCA2 MC UMACbk 2*2G/500_L/6L2.2/5R/ CB_n2_0_3D_HG_FR84	C2DT6600	NLED17.3WXGA+G	UMA	N	SO2GBI16	N500GB5.4KS	NSM8XS	5 in 1- Build in	SP1x2MMW	N	GM45	ICH9M	6CELL2.2	65W	0.3M DV

AS7736-664G50Mn	PA	Canada	LX.PHZ02.002	AS7736-664G50Mn W7HP64ATCA2 MC UMACbk 2*2G/500_L/6L2.2/5R/ CB_n2_0.3D_HG_FR81	C2DT6600	NLED17.3WXGA+G	UMA	N	SO2GBIi6	N500GB5.4KS	NSM8XS	5 in 1- Build in	SP1x2MMW	N	GM45	ICH9M	6CELL2.2	65W	0.3M DV
AS7736-664G50Mn	PA	Canada	LX.PHZ02.003	AS7736-664G50Mn W7HP64ATCA2 MC UMACbk 2*2G/500_L/6L2.2/5R/ CB_n2_0.3D_HG_FR82	C2DT6600	NLED17.3WXGA+G	UMA	N	SO2GBIi6	N500GB5.4KS	NSM8XS	5 in 1- Build in	SP1x2MMW	N	GM45	ICH9M	6CELL2.2	65W	0.3M DV
AS7736-872G25Mn	WW	WW	S2.PHZ02.002	AS7736-872G25Mn W7HP64AWW1 MC UMACbk 2*1G/250/BT/6L2.2/5R/ CB_n2_0.3D_HG_ES62	C2DP8700	NLED17.3WXGA+G	UMA	N	SO2GBIi6/ SO1GBIi6	N250GB5.4KS	NSM8XS	5 in 1- Build in	SP1x2MMW	BT 2.1/N	GM45	ICH9M	6CELL2.2	65W	0.3M DV
AS7736-872G25Mn	WW	GCTWN	S2.PHZ02.001	AS7736-872G25Mn W7HP64AWW1 MC UMACbk 2*1G/250/BT/6L2.2/5R/ CB_n2_0.3D_HG_ES61	C2DP8700	NLED17.3WXGA+G	UMA	N	SO2GBIi6/ SO1GBIi6	N250GB5.4KS	NSM8XS	5 in 1- Build in	SP1x2MMW	BT 2.1/N	GM45	ICH9M	6CELL2.2	65W	0.3M DV
AS7736-663G25Mn	EMEA	UK	LX.PHZ02.001	AS7736-663G25Mn W7HP64ATGB1 MC UMACbk 2G+1G/250/6L2.2/5R/ CB_n2_0.3D_HG_EN11	C2DT6600	NLED17.3WXGA+G	UMA	N	SO2GBIi6/ SO1GBIi6	N250GB5.4KS	NSM8XS	5 in 1- Build in	SP1x2MMW	N	GM45	ICH9M	6CELL2.2	65W	0.3M DV

## Aspire 7540 Series

Model	RO	Country	Acer Part No	Description	CPU	LCD	VGA Chip	VRAM 1	Memory 1/ Memory 2	HDD (1GB)	ODD	Card Reader	Wireless LAN1	Bluetooth	NB Chipset	SB Chipset	Battery	Adapter	Camera
AS7540G-304G50Mn	EMEA	Denmark	LX.PJC02.052	AS7540G-304G50Mn W7HP64ATDK2 MC M92XT512Cbk_V3 2*2G/500_L/BT/ 8L2.4/5R/CB_bgn_0.3D_HG_ENS1	AAM300	NLED17.3 WXGA+G	M92XT	512M-DDR3 (64*16*4)	SO2GBII6	N500G B 5.4KS	NSM8XS	5 in 1-Build in	3rd WIFI 1x2 BGN	BT 2.1	AMDRS880M	AMDSB710	8CELL2.4	90W	0.3M DV
AS7540G-304G50Mi	EMEA	Russia	LX.PJC02.051	AS7540G-304G50Mi W7HP64RUATRU1 MC M92XT512Cbk_V3 2*2G/500_L/BT/ 8L2.4/5R/CB_bg_0.3D_HG_RU11	AAM300	NLED17.3 WXGA+G	M92XT	512M-DDR3 (64*16*4)	SO2GBII6	N500G B 5.4KS	NSM8XS	5 in 1-Build in	3rd WIFI BG	BT 2.1	AMDRS880M	AMDSB710	8CELL2.4	90W	0.3M DV
AS7540G-303G32Mn	EMEA	Austria	LX.PJC02.049	AS7540G-303G32Mn W7HP64ATAT1 MC M92XT512Cbk_V3 2G+1G/320/ 8L2.4/5R/CB_bgn_0.3D_HG_DE61	AAM300	NLED17.3 WXGA+G	M92XT	512M-DDR3 (64*16*4)	SO2GBII6/ SO1GBII6	N320G B 5.4KS	NSM8XS	5 in 1-Build in	3rd WIFI 1x2 BGN	N	AMDRS880M	AMDSB710	8CELL2.4	90W	0.3M DV
AS7540G-303G32Mn	EMEA	Germany	LX.PJC02.047	AS7540G-303G32Mn W7HP64ATDE1 MC M92XT512Cbk_V3 2G+1G/320/ 8L2.4/5R/CB_bgn_0.3D_HG_DE11	AAM300	NLED17.3 WXGA+G	M92XT	512M-DDR3 (64*16*4)	SO2GBII6/ SO1GBII6	N320G B 5.4KS	NSM8XS	5 in 1-Build in	3rd WIFI 1x2 BGN	N	AMDRS880M	AMDSB710	8CELL2.4	90W	0.3M DV
AS7540G-304G32Mn	EMEA	Germany	LX.PJC02.050	AS7540G-304G32Mn W7HP64ATDE1 MC M92XT512Cbk_V3 2*2G/320/8L2.4/ 5R/CB_bgn_0.3D_HG_DE11	AAM300	NLED17.3 WXGA+G	M92XT	512M-DDR3 (64*16*4)	SO2GBII6	N320G B 5.4KS	NSM8XS	5 in 1-Build in	3rd WIFI 1x2 BGN	N	AMDRS880M	AMDSB710	8CELL2.4	90W	0.3M DV
AS7540G-524G50Mn	EMEA	Germany	LX.PJC02.048	AS7540G-524G50Mn W7HP64ATDE1 MC M92XT512Cbk_V3 2*2G/500_L/ 8L2.4/5R/CB_bgn_0.3D_HG_DE11	ATM520	NLED17.3 WXGA+G	M92XT	512M-DDR3 (64*16*4)	SO2GBII6	N500G B5.4KS	NSM8XS	5 in 1-Build in	3rd WIFI 1x2 BGN	N	AMDRS880M	AMDSB710	8CELL2.4	90W	0.3M DV
AS7540G-304G50Mn	EMEA	Middle East	LX.PJC02.009	AS7540G-304G50Mn EM W7HP64EMATME2 MC M92XT512Cbk_V3 2*2G/500_L/ 8L2.4/5R/CB_bgn_0.3D_HG_AR21	AAM300	NLED17.3 WXGA+G	M92XT	512M-DDR3 (64*16*4)	SO2GBII6	N500G B5.4KS	NSM8XS	5 in 1-Build in	3rd WIFI 1x2 BGN	N	AMDRS880M	AMDSB710	8CELL2.4	90W	0.3M DV
AS7540G-304G50Mn	EMEA	UK	LX.PJC02.019	AS7540G-304G50Mn W7HP64ATGB1 MC M92XT512Cbk_V3 2*2G/500_L/ 8L2.4/5R/CB_bgn_0.3D_HG_EN11	AAM300	NLED17.3 WXGA+G	M92XT	512M-DDR3 (64*16*4)	SO2GBII6	N500G B5.4KS	NSM8XS	5 in 1-Build in	3rd WIFI 1x2 BGN	N	AMDRS880M	AMDSB710	8CELL2.4	90W	0.3M DV
AS7540G-304G50Mn	EMEA	Serbia/ Macedonia	LX.PJC02.001	AS7540G-304G50Mn EM W7HP64ATCS1 MC M92XT512Cbk_V3 2*2G/500_L/ 8L2.4/5R/CB_bgn_0.3D_HG_SL11	AAM300	NLED17.3 WXGA+G	M92XT	512M-DDR3 (64*16*4)	SO2GBII6	N500G B5.4KS	NSM8XS	5 in 1-Build in	3rd WIFI 1x2 BGN	N	AMDRS880M	AMDSB710	8CELL2.4	90W	0.3M DV
AS7540G-304G50Mn	EMEA	Israel	LX.PJC02.003	AS7540G-304G50Mn W7HP64ATIL1 MC M92XT512Cbk_V3 2*2G/500_L/ 8L2.4/5R/CB_bgn_0.3D_HG_HE31	AAM300	NLED17.3 WXGA+G	M92XT	512M-DDR3 (64*16*4)	SO2GBII6	N500G B5.4KS	NSM8XS	5 in 1-Build in	3rd WIFI 1x2 BGN	N	AMDRS880M	AMDSB710	8CELL2.4	90W	0.3M DV
AS7540G-304G50Mn	EMEA	Israel	LX.PJC02.002	AS7540G-304G50Mn W7HP64ATIL1 MC M92XT512Cbk_V3 2*2G/500_L/ 8L2.4/5R/CB_bgn_0.3D_HG_HE11	AAM300	NLED17.3 WXGA+G	M92XT	512M-DDR3 (64*16*4)	SO2GBII6	N500G B5.4KS	NSM8XS	5 in 1-Build in	3rd WIFI 1x2 BGN	N	AMDRS880M	AMDSB710	8CELL2.4	90W	0.3M DV
AS7540G-304G50Mn	EMEA	Ukraine	LX.PJC02.004	AS7540G-304G50Mn W7HP64RUTUK1 MC M92XT512Cbk_V3 2*2G/500_L/ 8L2.4/5R/CB_bgn_0.3D_HG_RU61	AAM300	NLED17.3 WXGA+G	M92XT	512M-DDR3 (64*16*4)	SO2GBII6	N500G B5.4KS	NSM8XS	5 in 1-Build in	3rd WIFI 1x2 BGN	N	AMDRS880M	AMDSB710	8CELL2.4	90W	0.3M DV
AS7540G-304G50Mn	EMEA	Switzerland	LX.PJC02.020	AS7540G-304G50Mn W7HP64ATCH1 MC M92XT512Cbk_V3 2*2G/500_L/ 8L2.4/5R/CB_bgn_0.3D_HG_IT41	AAM300	NLED17.3 WXGA+G	M92XT	512M-DDR3 (64*16*4)	SO2GBII6	N500G B5.4KS	NSM8XS	5 in 1-Build in	3rd WIFI 1x2 BGN	N	AMDRS880M	AMDSB710	8CELL2.4	90W	0.3M DV
AS7540G-304G50Mn	EMEA	Italy	LX.PJC02.022	AS7540G-304G50Mn W7HP64ATT1 MC M92XT512Cbk_V3 2*2G/500_L/ 8L2.4/5R/CB_bgn_0.3D_HG_IT11	AAM300	NLED17.3 WXGA+G	M92XT	512M-DDR3 (64*16*4)	SO2GBII6	N500G B5.4KS	NSM8XS	5 in 1-Build in	3rd WIFI 1x2 BGN	N	AMDRS880M	AMDSB710	8CELL2.4	90W	0.3M DV
AS7540G-304G50Mi	EMEA	Russia	LX.PJC02.005	AS7540G-304G50Mi W7HP64RUATRU1 MC M92XT512Cbk_V3 2*2G/500_L/ 8L2.4/5R/CB_bg_0.3D_HG_RU11	AAM300	NLED17.3 WXGA+G	M92XT	512M-DDR3 (64*16*4)	SO2GBII6	N500G B5.4KS	NSM8XS	5 in 1-Build in	3rd WIFI BG	N	AMDRS880M	AMDSB710	8CELL2.4	90W	0.3M DV

AS7540G-304G50Mn	EMEA	Poland	LX.PJC02.021	AS7540G-304G50Mn W7HP64ATPL1 MC M92XT512Cbk_V3 2'2G/500_L/ 8L2.4/5R/CB_bgn_0.3D_HG_PL11	AAM300	NLED17.3 WXGA+G	M92XT	512M-DDR3 (64*16*4)	SO2GBII6	N500G B5.4KS	NSM8XS	5 in 1-Build in	3rd WIFI 1x2 BGN	N	AMDRS880M	AMDSB710	8CELL2.4	90W	0.3M DV
AS7540G-304G50Mn	EMEA	Eastern Europe	LX.PJC02.027	AS7540G-304G50Mn W7HP64ATEU5 MC M92XT512Cbk_V3 2'2G/500_L/ 8L2.4/5R/CB_bgn_0.3D_HG_PL71	AAM300	NLED17.3 WXGA+G	M92XT	512M-DDR3 (64*16*4)	SO2GBII6	N500G B5.4KS	NSM8XS	5 in 1-Build in	3rd WIFI 1x2 BGN	N	AMDRS880M	AMDSB710	8CELL2.4	90W	0.3M DV
AS7540G-304G50Mn	EMEA	Cyprus	LX.PJC02.026	AS7540G-304G50Mn W7HP64ATCY1 MC M92XT512Cbk_V3 2'2G/500_L/ 8L2.4/5R/CB_bgn_0.3D_HG_ES61	AAM300	NLED17.3 WXGA+G	M92XT	512M-DDR3 (64*16*4)	SO2GBII6	N500G B5.4KS	NSM8XS	5 in 1-Build in	3rd WIFI 1x2 BGN	N	AMDRS880M	AMDSB710	8CELL2.4	90W	0.3M DV
AS7540G-304G50Mn	EMEA	Finland	LX.PJC02.029	AS7540G-304G50Mn W7HP64ATFI2 MC M92XT512Cbk_V3 2'2G/500_L/ 8L2.4/5R/CB_bgn_0.3D_HG_FI11	AAM300	NLED17.3 WXGA+G	M92XT	512M-DDR3 (64*16*4)	SO2GBII6	N500G B5.4KS	NSM8XS	5 in 1-Build in	3rd WIFI 1x2 BGN	N	AMDRS880M	AMDSB710	8CELL2.4	90W	0.3M DV
AS7540G-304G50Mn	EMEA	Spain	LX.PJC02.025	AS7540G-304G50Mn W7HP64ATES1 MC M92XT512Cbk_V3 2'2G/500_L/ 8L2.4/5R/CB_bgn_0.3D_HG_ES51	AAM300	NLED17.3 WXGA+G	M92XT	512M-DDR3 (64*16*4)	SO2GBII6	N500G B5.4KS	NSM8XS	5 in 1-Build in	3rd WIFI 1x2 BGN	N	AMDRS880M	AMDSB710	8CELL2.4	90W	0.3M DV
AS7540G-304G50Mn	EMEA	Hungary	LX.PJC02.028	AS7540G-304G50Mn W7HP64ATHU1 MC M92XT512Cbk_V3 2'2G/500_L/ 8L2.4/5R/CB_bgn_0.3D_HG_HU11	AAM300	NLED17.3 WXGA+G	M92XT	512M-DDR3 (64*16*4)	SO2GBII6	N500G B5.4KS	NSM8XS	5 in 1-Build in	3rd WIFI 1x2 BGN	N	AMDRS880M	AMDSB710	8CELL2.4	90W	0.3M DV
AS7540G-304G50Mn	EMEA	Greece	LX.PJC02.023	AS7540G-304G50Mn W7HP64ATGR1 MC M92XT512Cbk_V3 2'2G/500_L/ 8L2.4/5R/CB_bgn_0.3D_HG_EL31	AAM300	NLED17.3 WXGA+G	M92XT	512M-DDR3 (64*16*4)	SO2GBII6	N500G B5.4KS	NSM8XS	5 in 1-Build in	3rd WIFI 1x2 BGN	N	AMDRS880M	AMDSB710	8CELL2.4	90W	0.3M DV
AS7540G-304G50Mn	EMEA	Portugal	LX.PJC02.024	AS7540G-304G50Mn W7HP64ATPT1 MC M92XT512Cbk_V3 2'2G/500_L/ 8L2.4/5R/CB_bgn_0.3D_HG_PT11	AAM300	NLED17.3 WXGA+G	M92XT	512M-DDR3 (64*16*4)	SO2GBII6	N500G B5.4KS	NSM8XS	5 in 1-Build in	3rd WIFI 1x2 BGN	N	AMDRS880M	AMDSB710	8CELL2.4	90W	0.3M DV
AS7540G-304G50Mn	EMEA	Eastern Europe	LX.PJC02.030	AS7540G-304G50Mn W7HP64ATEU5 MC M92XT512Cbk_V3 2'2G/500_L/ 8L2.4/5R/CB_bgn_0.3D_HG_RO11	AAM300	NLED17.3 WXGA+G	M92XT	512M-DDR3 (64*16*4)	SO2GBII6	N500G B5.4KS	NSM8XS	5 in 1-Build in	3rd WIFI 1x2 BGN	N	AMDRS880M	AMDSB710	8CELL2.4	90W	0.3M DV
AS7540G-304G50Mn	EMEA	Eastern Europe	LX.PJC02.031	AS7540G-304G50Mn W7HP64ATEU4 MC M92XT512Cbk_V3 2'2G/500_L/ 8L2.4/5R/CB_bgn_0.3D_HG_SV21	AAM300	NLED17.3 WXGA+G	M92XT	512M-DDR3 (64*16*4)	SO2GBII6	N500G B5.4KS	NSM8XS	5 in 1-Build in	3rd WIFI 1x2 BGN	N	AMDRS880M	AMDSB710	8CELL2.4	90W	0.3M DV
AS7540G-304G50Mn	EMEA	Eastern Europe	LX.PJC02.032	AS7540G-304G50Mn W7HP64ATEU7 MC M92XT512Cbk_V3 2'2G/500_L/ 8L2.4/5R/CB_bgn_0.3D_HG_ENQ1	AAM300	NLED17.3 WXGA+G	M92XT	512M-DDR3 (64*16*4)	SO2GBII6	N500G B5.4KS	NSM8XS	5 in 1-Build in	3rd WIFI 1x2 BGN	N	AMDRS880M	AMDSB710	8CELL2.4	90W	0.3M DV
AS7540G-304G50Mn	EMEA	Norway	LX.PJC02.040	AS7540G-304G50Mn W7HP64ATNO3 MC M92XT512Cbk_V3 2'2G/500_L/ 8L2.4/5R/CB_bgn_0.3D_HG_ENS1	AAM300	NLED17.3 WXGA+G	M92XT	512M-DDR3 (64*16*4)	SO2GBII6	N500G B5.4KS	NSM8XS	5 in 1-Build in	3rd WIFI 1x2 BGN	N	AMDRS880M	AMDSB710	8CELL2.4	90W	0.3M DV
AS7540G-304G50Mn	EMEA	Austria	LX.PJC02.034	AS7540G-304G50Mn W7HP64ATAT1 MC M92XT512Cbk_V3 2'2G/500_L/ 8L2.4/5R/CB_bgn_0.3D_HG_DE61	AAM300	NLED17.3 WXGA+G	M92XT	512M-DDR3 (64*16*4)	SO2GBII6	N500G B5.4KS	NSM8XS	5 in 1-Build in	3rd WIFI 1x2 BGN	N	AMDRS880M	AMDSB710	8CELL2.4	90W	0.3M DV
AS7540G-304G50Mn	EMEA	Czech	LX.PJC02.036	AS7540G-304G50Mn W7HP64ATCZ2 MC M92XT512Cbk_V3 2'2G/500_L/ 8L2.4/5R/CB_bgn_0.3D_HG_SK11	AAM300	NLED17.3 WXGA+G	M92XT	512M-DDR3 (64*16*4)	SO2GBII6	N500G B5.4KS	NSM8XS	5 in 1-Build in	3rd WIFI 1x2 BGN	N	AMDRS880M	AMDSB710	8CELL2.4	90W	0.3M DV
AS7540G-304G50Mn	EMEA	Sweden	LX.PJC02.035	AS7540G-304G50Mn W7HP64ATSE1 MC M92XT512Cbk_V3 2'2G/500_L/ 8L2.4/5R/CB_bgn_0.3D_HG_FI11	AAM300	NLED17.3 WXGA+G	M92XT	512M-DDR3 (64*16*4)	SO2GBII6	N500G B5.4KS	NSM8XS	5 in 1-Build in	3rd WIFI 1x2 BGN	N	AMDRS880M	AMDSB710	8CELL2.4	90W	0.3M DV
AS7540G-304G50Mn	EMEA	Eastern Europe	LX.PJC02.033	AS7540G-304G50Mn W7HP64ATEU7 MC M92XT512Cbk_V3 2'2G/500_L/ 8L2.4/5R/CB_bgn_0.3D_HG_SL11	AAM300	NLED17.3 WXGA+G	M92XT	512M-DDR3 (64*16*4)	SO2GBII6	N500G B5.4KS	NSM8XS	5 in 1-Build in	3rd WIFI 1x2 BGN	N	AMDRS880M	AMDSB710	8CELL2.4	90W	0.3M DV

AS7540G-304G50Mn	EMEA	Luxemburg	LX.PJC02.038	AS7540G-304G50Mn W7HP64ATL U3 MC M92XT512CbK_V3 2'2G/500_L/ 8L2.4/5R/CB_bgn_0.3D_HG_IT41	AAM300	NLED17.3 WXGA+G	M92XT	512M-DDR3 (64*16*4)	SO2GBII6	N500G B5.4KS	NSM8XS	5 in 1-Build in	3rd WIFI 1x2 BGN	N	AMDRS880M	AMDSB710	8CELL2.4	90W	0.3M DV
AS7540G-304G50Mn	EMEA	Belgium	LX.PJC02.041	AS7540G-304G50Mn W7HP64ATBE1 MC M92XT512CbK_V3 2'2G/500_L/ 8L2.4/5R/CB_bgn_0.3D_HG_NL11	AAM300	NLED17.3 WXGA+G	M92XT	512M-DDR3 (64*16*4)	SO2GBII6	N500G B5.4KS	NSM8XS	5 in 1-Build in	3rd WIFI 1x2 BGN	N	AMDRS880M	AMDSB710	8CELL2.4	90W	0.3M DV
AS7540G-304G50Mn	EMEA	Norway	LX.PJC02.039	AS7540G-304G50Mn W7HP64ATN01 MC M92XT512CbK_V3 2'2G/500_L/ 8L2.4/5R/CB_bgn_0.3D_HG_NO11	AAM300	NLED17.3 WXGA+G	M92XT	512M-DDR3 (64*16*4)	SO2GBII6	N500G B5.4KS	NSM8XS	5 in 1-Build in	3rd WIFI 1x2 BGN	N	AMDRS880M	AMDSB710	8CELL2.4	90W	0.3M DV
AS7540G-304G50Mn	EMEA	Holland	LX.PJC02.037	AS7540G-304G50Mn W7HP64ATNL1 MC M92XT512CbK_V3 2'2G/500_L/ 8L2.4/5R/CB_bgn_0.3D_HG_NL11	AAM300	NLED17.3 WXGA+G	M92XT	512M-DDR3 (64*16*4)	SO2GBII6	N500G B5.4KS	NSM8XS	5 in 1-Build in	3rd WIFI 1x2 BGN	N	AMDRS880M	AMDSB710	8CELL2.4	90W	0.3M DV
AS7540G-304G50Mn	EMEA	Germany	LX.PJC02.042	AS7540G-304G50Mn W7HP64ATDE1 MC M92XT512CbK_V3 2'2G/500_L/ 8L2.4/5R/CB_bgn_0.3D_HG_DE11	AAM300	NLED17.3 WXGA+G	M92XT	512M-DDR3 (64*16*4)	SO2GBII6	N500G B5.4KS	NSM8XS	5 in 1-Build in	3rd WIFI 1x2 BGN	N	AMDRS880M	AMDSB710	8CELL2.4	90W	0.3M DV
AS7540G-304G50Mn	EMEA	France	LX.PJC02.043	AS7540G-304G50Mn W7HP64ATFR1 MC M92XT512CbK_V3 2'2G/500_L/ 8L2.4/5R/CB_bgn_0.3D_HG_FR21	AAM300	NLED17.3 WXGA+G	M92XT	512M-DDR3 (64*16*4)	SO2GBII6	N500G B5.4KS	NSM8XS	5 in 1-Build in	3rd WIFI 1x2 BGN	N	AMDRS880M	AMDSB710	8CELL2.4	90W	0.3M DV
AS7540G-304G50Mn	EMEA	Denmark	LX.PJC02.045	AS7540G-304G50Mn W7HP64ATDK2 MC M92XT512CbK_V3 2'2G/500_L/ 8L2.4/5R/CB_bgn_0.3D_HG_ENS1	AAM300	NLED17.3 WXGA+G	M92XT	512M-DDR3 (64*16*4)	SO2GBII6	N500G B5.4KS	NSM8XS	5 in 1-Build in	3rd WIFI 1x2 BGN	N	AMDRS880M	AMDSB710	8CELL2.4	90W	0.3M DV
AS7540G-304G50Mn	EMEA	Denmark	LX.PJC02.044	AS7540G-304G50Mn W7HP64ATDK1 MC M92XT512CbK_V3 2'2G/500_L/ 8L2.4/5R/CB_bgn_0.3D_HG_NO11	AAM300	NLED17.3 WXGA+G	M92XT	512M-DDR3 (64*16*4)	SO2GBII6	N500G B5.4KS	NSM8XS	5 in 1-Build in	3rd WIFI 1x2 BGN	N	AMDRS880M	AMDSB710	8CELL2.4	90W	0.3M DV
AS7540G-304G50Mn	EMEA	Middle East	LX.PJC02.010	AS7540G-304G50Mn EM W7HP64EMATME6 MC M92XT512CbK_V3 2'2G/500_L/ 8L2.4/5R/CB_bgn_0.3D_HG_ES61	AAM300	NLED17.3 WXGA+G	M92XT	512M-DDR3 (64*16*4)	SO2GBII6	N500G B5.4KS	NSM8XS	5 in 1-Build in	3rd WIFI 1x2 BGN	N	AMDRS880M	AMDSB710	8CELL2.4	90W	0.3M DV
AS7540G-304G50Mn	EMEA	Middle East	LX.PJC02.008	AS7540G-304G50Mn EM W7HP64EMATME3 MC M92XT512CbK_V3 2'2G/500_L/ 8L2.4/5R/CB_bgn_0.3D_HG_ES81	AAM300	NLED17.3 WXGA+G	M92XT	512M-DDR3 (64*16*4)	SO2GBII6	N500G B5.4KS	NSM8XS	5 in 1-Build in	3rd WIFI 1x2 BGN	N	AMDRS880M	AMDSB710	8CELL2.4	90W	0.3M DV
AS7540G-304G50Mn	EMEA	Turkey	LX.PJC02.006	AS7540G-304G50Mn EM W7HP64EMATTR1 MC M92XT512CbK_V3 2'2G/500_L/ 8L2.4/5R/CB_bgn_0.3D_HG_TR31	AAM300	NLED17.3 WXGA+G	M92XT	512M-DDR3 (64*16*4)	SO2GBII6	N500G B5.4KS	NSM8XS	5 in 1-Build in	3rd WIFI 1x2 BGN	N	AMDRS880M	AMDSB710	8CELL2.4	90W	0.3M DV
AS7540G-304G50Mn	EMEA	Middle East	LX.PJC02.007	AS7540G-304G50Mn EM W7HP64EMATME2 MC M92XT512CbK_V3 2'2G/500_L/ 8L2.4/5R/CB_bgn_0.3D_HG_AR11	AAM300	NLED17.3 WXGA+G	M92XT	512M-DDR3 (64*16*4)	SO2GBII6	N500G B5.4KS	NSM8XS	5 in 1-Build in	3rd WIFI 1x2 BGN	N	AMDRS880M	AMDSB710	8CELL2.4	90W	0.3M DV
AS7540G-304G50Mn	EMEA	Middle East	LX.PJC02.011	AS7540G-304G50Mn EM W7HP64EMATME4 MC M92XT512CbK_V3 2'2G/500_L/ 8L2.4/5R/CB_bgn_0.3D_HG_RU61	AAM300	NLED17.3 WXGA+G	M92XT	512M-DDR3 (64*16*4)	SO2GBII6	N500G B5.4KS	NSM8XS	5 in 1-Build in	3rd WIFI 1x2 BGN	N	AMDRS880M	AMDSB710	8CELL2.4	90W	0.3M DV
AS7540G-304G50Mn	EMEA	Middle East	LX.PJC02.012	AS7540G-304G50Mn EM W7HP64EMATME4 MC M92XT512CbK_V3 2'2G/500_L/ 8L2.4/5R/CB_bgn_0.3D_HG_ES61	AAM300	NLED17.3 WXGA+G	M92XT	512M-DDR3 (64*16*4)	SO2GBII6	N500G B5.4KS	NSM8XS	5 in 1-Build in	3rd WIFI 1x2 BGN	N	AMDRS880M	AMDSB710	8CELL2.4	90W	0.3M DV
AS7540G-304G50Mn	EMEA	Middle East	LX.PJC02.016	AS7540G-304G50Mn EM W7HP64EMATME9 MC M92XT512CbK_V3 2'2G/500_L/ 8L2.4/5R/CB_bgn_0.3D_HG_ES81	AAM300	NLED17.3 WXGA+G	M92XT	512M-DDR3 (64*16*4)	SO2GBII6	N500G B5.4KS	NSM8XS	5 in 1-Build in	3rd WIFI 1x2 BGN	N	AMDRS880M	AMDSB710	8CELL2.4	90W	0.3M DV
AS7540G-304G50Mn	EMEA	Middle East	LX.PJC02.013	AS7540G-304G50Mn EM W7HP64EMATME2 MC M92XT512CbK_V3 2'2G/500_L/ 8L2.4/5R/CB_bgn_0.3D_HG_ES61	AAM300	NLED17.3 WXGA+G	M92XT	512M-DDR3 (64*16*4)	SO2GBII6	N500G B5.4KS	NSM8XS	5 in 1-Build in	3rd WIFI 1x2 BGN	N	AMDRS880M	AMDSB710	8CELL2.4	90W	0.3M DV

AS7540G-304G50Mn	EMEA	South Africa	LX.PJC02.018	AS7540G-304G50Mn EM W7HP64EMATZA1 MC M92XT512Cbk_V3 2*2G/500_L/ 8L2.4/5R/CB_bgn_0.3D_HG_ES81	AAM300	NLED17.3 WXGA+G	M92XT	512M-DDR3 (64*16*4)	SO2GBII6	N500G B5.4KS	NSM8XS	5 in 1-Build in	3rd WIFI 1x2 BGN	N	AMDRS880M	AMDSB710	8CELL2.4	90W	0.3M DV
AS7540G-304G50Mn	EMEA	Algeria	LX.PJC02.015	AS7540G-304G50Mn EM W7HP64EMATD21 MC M92XT512Cbk_V3 2*2G/500_L/ 8L2.4/5R/CB_bgn_0.3D_HG_ES81	AAM300	NLED17.3 WXGA+G	M92XT	512M-DDR3 (64*16*4)	SO2GBII6	N500G B5.4KS	NSM8XS	5 in 1-Build in	3rd WIFI 1x2 BGN	N	AMDRS880M	AMDSB710	8CELL2.4	90W	0.3M DV
AS7540G-304G50Mn	EMEA	South Africa	LX.PJC02.014	AS7540G-304G50Mn EM W7HP64EMATZA4 MC M92XT512Cbk_V3 2*2G/500_L/ 8L2.4/5R/CB_bgn_0.3D_HG_ES61	AAM300	NLED17.3 WXGA+G	M92XT	512M-DDR3 (64*16*4)	SO2GBII6	N500G B5.4KS	NSM8XS	5 in 1-Build in	3rd WIFI 1x2 BGN	N	AMDRS880M	AMDSB710	8CELL2.4	90W	0.3M DV
AS7540G-304G50Mn	EMEA	South Africa	LX.PJC02.017	AS7540G-304G50Mn EM W7HP64EMATZA2 MC M92XT512Cbk_V3 2*2G/500_L/ 8L2.4/5R/CB_bgn_0.3D_HG_ES61	AAM300	NLED17.3 WXGA+G	M92XT	512M-DDR3 (64*16*4)	SO2GBII6	N500G B5.4KS	NSM8XS	5 in 1-Build in	3rd WIFI 1x2 BGN	N	AMDRS880M	AMDSB710	8CELL2.4	90W	0.3M DV
AS7540G-304G50Mn	EMEA	France	LX.PJC02.046	AS7540G-304G50Mn W7HP64ATFR1 MC M92XT512Cbk_V3 2*2G/500_L/ 8L2.4/5R/CB_bgn_0.3D_HG_FR21	AAM300	NLED17.3 WXGA+G	M92XT	512M-DDR3 (64*16*4)	SO2GBII6	N500G B5.4KS	NSM8XS	5 in 1-Build in	3rd WIFI 1x2 BGN	N	AMDRS880M	AMDSB710	8CELL2.4	90W	0.3M DV
AS7540G-324G50Bn	WW	GCTWN	S2.PJC02.001	AS7540G-324G50Bn W7HP64AWW1 MC M92XT512Cbk_V3 2*2G/500_L/BT/ 8L2.4/5R/CB_bgn_0.3D_HG_ES61	AAM320	NLED17.3 WXGA+G	M92XT	512M-DDR3 (64*16*4)	SO2GBII6	N500G B5.4KS	NBDCB4X S	5 in 1-Build in	3rd WIFI 1x2 BGN	BT 2.1	AMDRS880M	AMDSB710	8CELL2.4	90W	0.3M DV
AS7540G-324G50Bn	WW	WW	S2.PJC02.002	AS7540G-324G50Bn W7HP64AWW1 MC M92XT512Cbk_V3 2*2G/500_L/BT/ 8L2.4/5R/CB_bgn_0.3D_HG_ES62	AAM320	NLED17.3 WXGA+G	M92XT	512M-DDR3 (64*16*4)	SO2GBII6	N500G B5.4KS	NBDCB4X S	5 in 1-Build in	3rd WIFI 1x2 BGN	BT 2.1	AMDRS880M	AMDSB710	8CELL2.4	90W	0.3M DV
AS7540G-502G25Mn	AAP	Vietnam	LX.PJC0C.012	AS7540G-502G25Mn LNPUSAVN1 M92XT512Cbk_V3 1*2G/250/BT/ 8L2.4/5R/CB_bgn_0.3D_HG_EN11	ATM500	NLED17.3 WXGA+G	M92XT	512M-DDR3 (64*16*4)	SO2GBII6/ N	N250G B5.4KS	NSM8XS	5 in 1-Build in	3rd WIFI 1x2 BGN	BT 2.1	AMDRS880M	AMDSB710	8CELL2.4	90W	0.3M DV
AS7540G-322G32Mn	AAP	Vietnam	LX.PJC0C.007	AS7540G-322G32Mn LNPUSAVN1 M92XT512Cbk_V3 1*2G/250/BT/ 8L2.4/5R/CB_bgn_0.3D_HG_EN11	AAM320	NLED17.3 WXGA+G	M92XT	512M-DDR3 (64*16*4)	SO2GBII6/ N	N320G B5.4KS	NSM8XS	5 in 1-Build in	3rd WIFI 1x2 BGN	BT 2.1	AMDRS880M	AMDSB710	8CELL2.4	90W	0.3M DV
AS7540G-604G50Mn	AAP	Vietnam	LX.PJC0C.005	AS7540G-604G50Mn LNPUSAVN1 M92XT512Cbk_V3 2*2G/500_L/BT/ 8L2.4/5R/CB_bgn_0.3D_HG_EN11	ATUM600	NLED17.3 WXGA+G	M92XT	512M-DDR3 (64*16*4)	SO2GBII6	N500G B5.4KS	NSM8XS	5 in 1-Build in	3rd WIFI 1x2 BGN	BT 2.1	AMDRS880M	AMDSB710	8CELL2.4	90W	0.3M DV
AS7540G-624G50Mn	AAP	Vietnam	LX.PJC0C.003	AS7540G-624G50Mn LNPUSAVN1 M92XT512Cbk_V3 2*2G/500_L/BT/ 8L2.4/5R/CB_bgn_0.3D_HG_EN11	ATUM620	NLED17.3 WXGA+G	M92XT	512M-DDR3 (64*16*4)	SO2GBII6	N500G B5.4KS	NSM8XS	5 in 1-Build in	3rd WIFI 1x2 BGN	BT 2.1	AMDRS880M	AMDSB710	8CELL2.4	90W	0.3M DV
AS7540G-323G32Mn	AAP	Vietnam	LX.PJC0C.002	AS7540G-323G32Mn LNPUSAVN1 M92XT512Cbk_V3 2G+1G/320/BT/ 8L2.4/5R/CB_bgn_0.3D_HG_EN11	AAM320	NLED17.3 WXGA+G	M92XT	512M-DDR3 (64*16*4)	SO2GBII6	N320G B5.4KS	NSM8XS	5 in 1-Build in	3rd WIFI 1x2 BGN	BT 2.1	AMDRS880M	AMDSB710	8CELL2.4	90W	0.3M DV
AS7540G-322G25Mn	AAP	Vietnam	LX.PJC0C.013	AS7540G-322G25Mn LNPUSAVN1 M92XT512Cbk_V3 1*2G/250/BT/ 8L2.4/5R/CB_bgn_0.3D_HG_EN11	AAM320	NLED17.3 WXGA+G	M92XT	512M-DDR3 (64*16*4)	SO2GBII6/ N	N250G B5.4KS	NSM8XS	5 in 1-Build in	3rd WIFI 1x2 BGN	BT 2.1	AMDRS880M	AMDSB710	8CELL2.4	90W	0.3M DV
AS7540G-644G50Mn	AAP	Vietnam	LX.PJC0C.004	AS7540G-644G50Mn LNPUSAVN1 M92XT512Cbk_V3 2*2G/500_L/BT/ 8L2.4/5R/CB_bgn_0.3D_HG_EN11	ATUM640	NLED17.3 WXGA+G	M92XT	512M-DDR3 (64*16*4)	SO2GBII6	N500G B5.4KS	NSM8XS	5 in 1-Build in	3rd WIFI 1x2 BGN	BT 2.1	AMDRS880M	AMDSB710	8CELL2.4	90W	0.3M DV
AS7540G-622G25Mn	AAP	Vietnam	LX.PJC0C.009	AS7540G-622G25Mn LNPUSAVN1 M92XT512Cbk_V3 1*2G/250/BT/ 8L2.4/5R/CB_bgn_0.3D_HG_EN11	ATUM620	NLED17.3 WXGA+G	M92XT	512M-DDR3 (64*16*4)	SO2GBII6/ N	N250G B5.4KS	NSM8XS	5 in 1-Build in	3rd WIFI 1x2 BGN	BT 2.1	AMDRS880M	AMDSB710	8CELL2.4	90W	0.3M DV
AS7540G-642G25Mn	AAP	Vietnam	LX.PJC0C.008	AS7540G-642G25Mn LNPUSAVN1 M92XT512Cbk_V3 1*2G/250/BT/ 8L2.4/5R/CB_bgn_0.3D_HG_EN11	ATUM640	NLED17.3 WXGA+G	M92XT	512M-DDR3 (64*16*4)	SO2GBII6/ N	N250G B5.4KS	NSM8XS	5 in 1-Build in	3rd WIFI 1x2 BGN	BT 2.1	AMDRS880M	AMDSB710	8CELL2.4	90W	0.3M DV
AS7540G-504G50Mn	AAP	Vietnam	LX.PJC0C.006	AS7540G-504G50Mn LNPUSAVN1 M92XT512Cbk_V3 2*2G/500_L/BT/ 8L2.4/5R/CB_bgn_0.3D_HG_EN11	ATM500	NLED17.3 WXGA+G	M92XT	512M-DDR3 (64*16*4)	SO2GBII6	N500G B5.4KS	NSM8XS	5 in 1-Build in	3rd WIFI 1x2 BGN	BT 2.1	AMDRS880M	AMDSB710	8CELL2.4	90W	0.3M DV
AS7540G-503G32Mn	AAP	Vietnam	LX.PJC0C.001	AS7540G-503G32Mn LNPUSAVN1 M92XT512Cbk_V3 2G+1G/320/BT/ 8L2.4/5R/CB_bgn_0.3D_HG_EN11	ATM500	NLED17.3 WXGA+G	M92XT	512M-DDR3 (64*16*4)	SO2GBII6	N320G B5.4KS	NSM8XS	5 in 1-Build in	3rd WIFI 1x2 BGN	BT 2.1	AMDRS880M	AMDSB710	8CELL2.4	90W	0.3M DV
AS7540G-522G25Mn	AAP	Vietnam	LX.PJC0C.011	AS7540G-522G25Mn LNPUSAVN1 M92XT512Cbk_V3 1*2G/250/BT/ 8L2.4/5R/CB_bgn_0.3D_HG_EN11	ATM520	NLED17.3 WXGA+G	M92XT	512M-DDR3 (64*16*4)	SO2GBII6/ N	N250G B5.4KS	NSM8XS	5 in 1-Build in	3rd WIFI 1x2 BGN	BT 2.1	AMDRS880M	AMDSB710	8CELL2.4	90W	0.3M DV



AS7540G-602G25Mn	AAP	Vietnam	LX.PJC0C.010	AS7540G-602G25Mn LINPUSAVN1 M92XT512Cbk_V3 1*2G/250/B/7/8L2.4/5R/CB_bgn_0.3D_HG_EN11	ATUM600	NLED17.3 WXGA+G	M92XT	512M-DDR3 (64*16*4)	SO2GBII6/ N	N250G B5.4KS	NSM8XS	5 in 1-Build in	3rd WIFI 1x2 BGN	BT 2.1	AMDRS880M	AMDSB710	8CELL2.4	90W	0.3M DV
AS7540-304G32Mn	PA	ACLA-Portuguese	LX.PJD02.006	AS7540-304G32Mn EM W7HP64EMATXC2 MC UMACbk 2*2G/320/B/6L2.2/5R/ CB_bgn_0.3D_HG_XC21	AAM300	NLED17.3 WXGA+G	UMA	N	SO2GBII6	N320G B5.4KS	NSM8XS	5 in 1-Build in	3rd WIFI 1x2 BGN	BT 2.1	AMDRS880M	AMDSB710	6CELL2.2	65W	0.3M DV
AS7540-303G32Mn	EMEA	UK	LX.PJD02.002	AS7540-303G32Mn W7HP64ATGB1 MC UMACbk 2*G+1G/320/6L2.2/5R/ CB_bgn_0.3D_N_HG_EN11	AAM300	NLED17.3 WXGA+G	UMA	N	SO2GBII6/ SO1GBII6	N320G B5.4KS	NSM8XS	5 in 1-Build in	3rd WIFI 1x2 BGN	N	AMDRS880M	AMDSB710	6CELL2.2	65W	0.3M DV
AS7540-304G50Mn	EMEA	France	LX.PJD02.018	AS7540-304G50Mn W7HP64ATFR1 MC UMACbk 2*2G/500_L/6L2.2/5R/ CB_bgn_0.3D_HG_FR21	AAM300	NLED17.3 WXGA+G	UMA	N	SO2GBII6	N500G B5.4KS	NSM8XS	5 in 1-Build in	3rd WIFI 1x2 BGN	N	AMDRS880M	AMDSB710	6CELL2.2	65W	0.3M DV
AS7540-304G50Mn	PA	USA	LX.PJD02.017	AS7540-304G50Mn W7HP64ATUS1 MC UMACbk 2*2G/500_L/6L2.2/5R/ CB_bgn_0.3D_HG_FRB3	AAM300	NLED17.3 WXGA+G	UMA	N	SO2GBII6	N500G B5.4KS	NSM8XS	5 in 1-Build in	3rd WIFI 1x2 BGN	N	AMDRS880M	AMDSB710	6CELL2.2	65W	0.3M DV
AS7540-304G50Mn	PA	USA	LX.PJD02.016	AS7540-304G50Mn W7HP64ATUS1 MC UMACbk 2*2G/500_L/6L2.2/5R/ CB_bgn_0.3D_HG_FRB2	AAM300	NLED17.3 WXGA+G	UMA	N	SO2GBII6	N500G B5.4KS	NSM8XS	5 in 1-Build in	3rd WIFI 1x2 BGN	N	AMDRS880M	AMDSB710	6CELL2.2	65W	0.3M DV
AS7540-304G50Mn	PA	USA	LX.PJD02.015	AS7540-304G50Mn W7HP64ATUS1 MC UMACbk 2*2G/500_L/6L2.2/5R/ CB_bgn_0.3D_HG_FRB1	AAM300	NLED17.3 WXGA+G	UMA	N	SO2GBII6	N500G B5.4KS	NSM8XS	5 in 1-Build in	3rd WIFI 1x2 BGN	N	AMDRS880M	AMDSB710	6CELL2.2	65W	0.3M DV
AS7540-304G50Mn	PA	Canada	LX.PJD02.014	AS7540-304G50Mn W7HP64ATCA2 MC UMACbk 2*2G/500_L/6L2.2/5R/ CB_bgn_0.3D_HG_FR84	AAM300	NLED17.3 WXGA+G	UMA	N	SO2GBII6	N500G B5.4KS	NSM8XS	5 in 1-Build in	3rd WIFI 1x2 BGN	N	AMDRS880M	AMDSB710	6CELL2.2	65W	0.3M DV
AS7540-304G50Mn	PA	Canada	LX.PJD02.013	AS7540-304G50Mn W7HP64ATCA2 MC UMACbk 2*2G/500_L/6L2.2/5R/ CB_bgn_0.3D_HG_FR82	AAM300	NLED17.3 WXGA+G	UMA	N	SO2GBII6	N500G B5.4KS	NSM8XS	5 in 1-Build in	3rd WIFI 1x2 BGN	N	AMDRS880M	AMDSB710	6CELL2.2	65W	0.3M DV
AS7540-304G50Mn	PA	Canada	LX.PJD02.012	AS7540-304G50Mn W7HP64ATCA2 MC UMACbk 2*2G/500_L/6L2.2/5R/ CB_bgn_0.3D_HG_FR81	AAM300	NLED17.3 WXGA+G	UMA	N	SO2GBII6	N500G B5.4KS	NSM8XS	5 in 1-Build in	3rd WIFI 1x2 BGN	N	AMDRS880M	AMDSB710	6CELL2.2	65W	0.3M DV
AS7540-304G32Mn	PA	Chile	LX.PJD02.011	AS7540-304G32Mn EM W7HP64EMATCL3 MC UMACbk 2*2G/320/B/6L2.2/5R/ CB_bgn_0.3D_HG_ES51	AAM300	NLED17.3 WXGA+G	UMA	N	SO2GBII6	N320G B5.4KS	NSM8XS	5 in 1-Build in	3rd WIFI 1x2 BGN	BT 2.1	AMDRS880M	AMDSB710	6CELL2.2	65W	0.3M DV
AS7540-304G32Mn	PA	ACLA-Spanish	LX.PJD02.010	AS7540-304G32Mn EM W7HP64EMATEA4 MC UMACbk 2*2G/320/B/6L2.2/5R/ CB_bgn_0.3D_HG_EN31	AAM300	NLED17.3 WXGA+G	UMA	N	SO2GBII6	N320G B5.4KS	NSM8XS	5 in 1-Build in	3rd WIFI 1x2 BGN	BT 2.1	AMDRS880M	AMDSB710	6CELL2.2	65W	0.3M DV
AS7540-304G32Mn	PA	ACLA-Spanish	LX.PJD02.009	AS7540-304G32Mn EM W7HP64EMATEA1 MC UMACbk 2*2G/320/B/6L2.2/5R/ CB_bgn_0.3D_HG_ES51	AAM300	NLED17.3 WXGA+G	UMA	N	SO2GBII6	N320G B5.4KS	NSM8XS	5 in 1-Build in	3rd WIFI 1x2 BGN	BT 2.1	AMDRS880M	AMDSB710	6CELL2.2	65W	0.3M DV
AS7540-304G32Mn	PA	ACLA-Spanish	LX.PJD02.008	AS7540-304G32Mn EM W7HP64EMATEA3 MC UMACbk 2*2G/320/B/6L2.2/5R/ CB_bgn_0.3D_HG_ES51	AAM300	NLED17.3 WXGA+G	UMA	N	SO2GBII6	N320G B5.4KS	NSM8XS	5 in 1-Build in	3rd WIFI 1x2 BGN	BT 2.1	AMDRS880M	AMDSB710	6CELL2.2	65W	0.3M DV
AS7540-304G32Mn	PA	ACLA-Portuguese	LX.PJD02.007	AS7540-304G32Mn EM W7HP64EMATXC3 MC UMACbk 2*2G/320/B/6L2.2/5R/ CB_bgn_0.3D_HG_EN61	AAM300	NLED17.3 WXGA+G	UMA	N	SO2GBII6	N320G B5.4KS	NSM8XS	5 in 1-Build in	3rd WIFI 1x2 BGN	BT 2.1	AMDRS880M	AMDSB710	6CELL2.2	65W	0.3M DV
AS7540-302G16Mn	EMEA	UK	LX.PJD02.005	AS7540-302G16Mn W7HP64ATGB1 MC UMACbk 1*2G/160/6L2.2/5R/ CB_bgn_0.3D_HG_EN11	AAM300	NLED17.3 WXGA+G	UMA	N	SO2GBII6 N	N160G B5.4KS	NSM8XS	5 in 1-Build in	3rd WIFI 1x2 BGN	N	AMDRS880M	AMDSB710	6CELL2.2	65W	0.3M DV
AS7540-302G16Mn	EMEA	UK	LX.PJD02.004	AS7540-302G16Mn W7HP64ATGB1 MC UMACbk 2*1G/160/6L2.2/5R/ CB_bgn_0.3D_HG_EN11	AAM300	NLED17.3 WXGA+G	UMA	N	SO1GBII6	N160G B5.4KS	NSM8XS	5 in 1-Build in	3rd WIFI 1x2 BGN	N	AMDRS880M	AMDSB710	6CELL2.2	65W	0.3M DV
AS7540-304G32Mn	PA	Canada	LX.PJD02.001	AS7540-304G32Mn W7HP64ATCA2 MC UMACbk 2*2G/320/6L2.2/5R/ CB_bgn_0.3D_HG_FR81	AAM300	NLED17.3 WXGA+G	UMA	N	SO2GBII6	N320G B5.4KS	NSM8XS	5 in 1-Build in	3rd WIFI 1x2 BGN	N	AMDRS880M	AMDSB710	6CELL2.2	65W	0.3M DV
AS7540-322G32Mn	WW	GCTWN	S2.PJD02.001	AS7540-322G32Mn W7HP64AWW1 MC UMACbk 2*1G/320/B/7/6L2.2/5R/CB_bgn_0.3D_HG_ES61	AAM320	NLED17.3 WXGA+G	UMA	N	SO1GBII6	N320G B5.4KS	NSM8XS	5 in 1-Build in	3rd WIFI 1x2 BGN	BT 2.1	AMDRS880M	AMDSB710	6CELL2.2	65W	0.3M DV

AS7540-322G32Mn	WW	WW	S2.PJD02.002	AS7540-322G32Mn W7HP64AWW1 MC UMACbk 2*1G/320/BT/6L2.2/ 5R/CB_bgn_0.3D_HG_ES62	AAM320	NLED17.3 WXGA+G	UMA	N	SO1GBII6	N320G B5.4KS	NSM8XS	5 in 1-Build in	3rd WIFI 1x2 BGN	BT 2.1	AMDRS880M	AMDSB710	6CELL2.2	65W	0.3M DV
AS7540-304G32Mn	PA	Canada	LX.PJD02.003	AS7540-304G32Mn W7HP64ATCA2 MC UMACbk 2*2G/320/6L2.2/5R/ CB_bgn_0.3D_HG_FR82	AAM300	NLED17.3 WXGA+G	UMA	N	SO2GBII6	N320G B5.4KS	NSM8XS	5 in 1-Build in	3rd WIFI 1x2 BGN	N	AMDRS880M	AMDSB710	6CELL2.2	65W	0.3M DV

# Test Compatible Components

---

This computer's compatibility is tested and verified by Acer's internal testing department. All of its system functions are tested under Windows® XP Home, Windows® XP Pro environment, Windows® Vista.

Refer to the following lists for components, adapter cards, and peripherals which have passed these tests. Regarding configuration, combination and test procedures, please refer to the Aspire 7736/7736Z/7336 series and Aspire 7540 Series Compatibility Test Report released by the Acer Mobile System Testing Department.

# Microsoft® Windows® Vista Environment Test

Item	Specification
<b>CRT Port Test</b>	
CRT Monitor	Acer 211c 21", ViewSonic G220F, ViewSonic PF790 19"
LCD Monitor	Acer FP751 17" TFT LCD, Acer AL1521, Acer AL1721, ViewSonic VD201b, Westinghouse W37G, HP LP2065, HP S9500
Projector	Dell 3300MP
<b>USB Port Test</b>	
USB Keyboard/Mouse	Microsoft Natural Keyboard Pro Dell USB Keyboard Logicool USB Mouse (OWCM-USB) Logitech USB Wheel Mouse Logitech First Wheel Mouse Dell by Logitech Dell Internet Navigator Keyboard Dell Smart Card Keyboard HP USB Optical Austin Mouse Belkin Miniglow Optical USB Mouse HP USB Optical Mouse (RB129AA)
USB Speaker/Joystick	Aiwa Multimedia Digital Speaker (SC-UC78) Panasonic USB Speaker EAB-MPC57USB
USB Storage Drive	Iomega USB Zip 250MB Transcend 80G HDD Plextor DVD+R/RW LG DVD+R/RW Sony DVD+R/RW
USB Camera	Intel Easy PC Camera (A20953-001) Orange Micro USB 2.0 Web Cam
USB HUB and Others	A TEN UH-204 IOGEAR 4-Port Hub Corega CG-WLUSBST11
USB Printer/Scanner	HP 450WBT Deskjet Printer
USB Flash Drive	Sony Memory Key 128MB Sony Micro Vault Pro USD-5G IBM 128MB Memory Key IBM 512MB Memory Key Apacer Handy Drive Apacer The USB Flash Drive 256MB
USB ODD	Logitech CDRW+DVDROM combo LG DVD+R/RW Sony DVD+R/RW
1394 Camera	Sony DV-TRV10
Access Point 802.11a	Intel Pro/Wireless 5000 NetGear HE 102
Access Point 802.11g	D-Link Building Networks People WiFi Certified a/b/g Wireless 108AG
Access Point 802.11n	Belkin N1MIMO Wireless Router High Performance wireless 802.11n
Bluetooth Device	Sony Ericsson Wireless Headset Sony Ericsson T610 X Bridge Bluetooth Access Point BT300

Item	Specification
<b>PCMCIA Test</b>	
LAN/Modem Card	TDK CardBus Ethernet 10/100 32-Bit CBE-10/100BTX
Storage Card	Hitachi Microdrive 4G
1394 Card	Buffalo 1394 Interface Cardbus (IFC-ILCB/DV)
USB2.0 Card	IBM EtherJet CardBus Adapter 10/100
Wireless Lan Card (Not recommended for wireless ready model)	Cisco Wireless LAN Card 802.11a NETGEAR Wireless LAN card 802.11a
ISDN Card	Toshiba Type B for Bluetooth 128K ISDN Card
GPRS Card	Vodafone QL1ACC-21581 3G/GPRS card Sony Ericsson GC83 GPRS card Sony Ericsson GC89 GPRS card
<b>ExpressCard Test</b>	
Express Card	Abcom 5-in-1 Adapter ExpressCard Reader Abcom GigaLan ExpressCard Sunix ECF2400 2 Ports 1394A ExpressCard
<b>Memory Card Test (SD/MS/MMC/SM/CF/Microdrive/XD)</b>	
SD Card	Apacer 128/256MB SanDisk 256MB Apacer 2GB (150x Hi-Speed) KINGMAX 1GB (66x Hi-Speed) SanDisk 1GB RiDATA 4GB SD PRO Memory Card
MS Card	Sony 512 MS PRO Lexar 512MB MS PRO Lexar 1GB MS PRO Sony 2GB MS PRO
MMC Card	SanDisk 32MB Transcend 64/128MB Transcend 256MB SanDisk RS-MMC 128MB PQI RS-MMC 256MB Transcend 512MB A-DATA Turbo 200X 2GB MMC Card
XD Card	Apacer 256/512MB SanDisk 2GB Olympus 512MB
CF Card	Apacer 256/512 SanDisk 2GB



# Online Support Information

---

This section describes online technical support services available to help you repair your Acer Systems.

If you are a distributor, dealer, ASP or TPM, please refer your technical queries to your local Acer branch office. Acer Branch Offices and Regional Business Units may access our website. However some information sources will require a user i.d. and password. These can be obtained directly from Acer CSD Taiwan.

Acer's Website offers you convenient and valuable support resources whenever you need them.

In the Technical Information section you can download information on all of Acer's Notebook, Desktop and Server models including:

- Service guides for all models
- User's manuals
- Training materials
- Bios updates
- Software utilities
- Spare parts lists
- TABs (Technical Announcement Bulletin)

For these purposes, we have included an Acrobat File to facilitate the problem-free downloading of our technical material.

Also contained on this website are:

- Detailed information on Acer's International Traveller's Warranty (ITW)
- Returned material authorization procedures
- An overview of all the support services we offer, accompanied by a list of telephone, fax and email contacts for all your technical queries.

We are always looking for ways to optimize and improve our services, so if you have any suggestions or comments, please do not hesitate to communicate these to us.





**A**

AFLASH Utility 39  
 antennas  
   removing 84  
 Audio 23

**B**

Back cover  
   removing 46  
 battery pack  
   removing 45  
 BIOS 19  
   vendor 19  
   Version 19  
 BIOS Recovery 105  
 BIOS Recovery Boot Block 107  
 BIOS Recovery by Crisis Disk 107  
   steps 107  
 BIOS Recovery Hotkey 107  
 BIOS Utility 27–39  
   Navigating 28  
   System Security 38  
 block diagram  
   Aspire 7540 Series 5  
   Aspire 7738/7738G Series and 7735/7735G/  
   7735Z/7735ZG Series 4  
 bluetooth board  
   removing 72  
 button/indicator  
   Bluetooth 11  
   Wireless LAN 11  
 buttons  
   easy-launch 11

**C**

caps lock  
   on indicator 7  
 Clearing BIOS Password  
   steps 106  
 Clearing Password 105  
 computer  
   on indicator 7  
 CPU  
   removing 54  
 CPU Fan True Value Table 19  
 Crisis Disk  
   creating 107  
 Crisis Recovery Disk 39

**D**

DIMM module  
   removing 51

**E**

Environment Test 172  
 Euro 15  
 External CD-ROM Drive Check 86  
 External Module Disassembly  
   Flowchart 43

**F**

Fingerprint/button and touchpad boards  
   removing 66  
 Flash Utility 39  
 FRU (Field Replaceable Unit) List 111

**H**

Hard disk 21  
 HDD 21  
 HDD1 module  
   removing 48  
 Hot Keys 13, 15  
 Hotkeys  
   sleep 15  
 hotkeys  
   Bluetooth 15  
   brightness down 15  
   brightness up 15  
   display 15  
   Screen blank 15  
   speaker 15  
   System property 15  
   volume down 15  
   volume up 15  
 HW Gap position 105

**I**

indicator  
   battery 10  
   power-on 10  
 Indicators 10  
 Intermittent Problems 101

**K**

Key  
   Special 15  
 key  
   Backup 11

---

- US dollar 15
- Keyboard 13, 25
  - removing 60
- Keyboard or Auxiliary Input Device Check 86

## L

- Launch board
  - removing 71
- LCD bezel
  - removing 78
- LCD Brackets
  - removing 81
- LCD Module Disassembly
  - Flowchart 77
- LCD with the brackets
  - removing 79
- Locations
  - connectors 103

## M

- Main Screw List 42
- Main Unit Disassembly
  - Flowchart 57
- media access
  - on indicator 7
- Memory Check 87
- menu
  - Boot 37
  - Exit 38
  - Information 29
  - Security 33
- middle cover
  - removing 58
- Model Definition 143
- modem board
  - removing 71

## N

- notebook tour 6
- num lock
  - on indicator 7

## O

- Online Support Information 175

## P

- password
  - changing 35
  - removing 35
  - setting 34

- Power Adapter Check 87
- Power System Check 87
  - Battery Pack 88
- Power-On Self-Test (POST) Error Message 88
- Processor 19

## S

- Screw List 42
- System 4
  - Block Diagram 4
- System Check Procedures 86
- System Memory 19
- System Utilities 17, 27
- System utilities
  - Acer GridVista 18

## T

- Test Compatible Components 171
- touchpad
  - using 11
- Touchpad Check 88
- Troubleshooting 85

## U

- Undetermined Problems 102
- utility
  - BIOS 27–39

## V

- view
  - bottom 10
  - left 8
  - rear 9
  - right 9
- view front 6

## W

- Windows 2000 Environment Test 172