

# Aspire 7730/7730G Series Service Guide

Service guide files and updates are available on the ACER/CSD web; for more information, please refer to <http://csd.acer.com.tw>

PRINTED IN TAIWAN

---

# Revision History

Please refer to the table below for the updates made on Aspire 7730/7730G Series service guide.

Date	Chapter	Updates

---

## Copyright

Copyright © 2008 by Acer Incorporated. All rights reserved. No part of this publication may be reproduced, transmitted, transcribed, stored in a retrieval system, or translated into any language or computer language, in any form or by any means, electronic, mechanical, magnetic, optical, chemical, manual or otherwise, without the prior written permission of Acer Incorporated.

## Disclaimer

The information in this guide is subject to change without notice.

Acer Incorporated makes no representations or warranties, either expressed or implied, with respect to the contents hereof and specifically disclaims any warranties of merchantability or fitness for any particular purpose. Any Acer Incorporated software described in this manual is sold or licensed "as is". Should the programs prove defective following their purchase, the buyer (and not Acer Incorporated, its distributor, or its dealer) assumes the entire cost of all necessary servicing, repair, and any incidental or consequential damages resulting from any defect in the software.

Acer is a registered trademark of Acer Corporation.

Intel is a registered trademark of Intel Corporation.

Pentium and Pentium II/III are trademarks of Intel Corporation.

Other brand and product names are trademarks and/or registered trademarks of their respective holders.

---

## Conventions

The following conventions are used in this manual:

<b>SCREEN MESSAGES</b>	Denotes actual messages that appear on screen.
<b>NOTE</b>	Gives bits and pieces of additional information related to the current topic.
<b>WARNING</b>	Alerts you to any damage that might result from doing or not doing specific actions.
<b>CAUTION</b>	Gives precautionary measures to avoid possible hardware or software problems.
<b>IMPORTANT</b>	Reminds you to do specific actions relevant to the accomplishment of procedures.

---

## Preface

Before using this information and the product it supports, please read the following general information.

1. This Service Guide provides you with all technical information relating to the BASIC CONFIGURATION decided for Acer's "global" product offering. To better fit local market requirements and enhance product competitiveness, your regional office MAY have decided to extend the functionality of a machine (e.g. add-on card, modem, or extra memory capability). These LOCALIZED FEATURES will NOT be covered in this generic service guide. In such cases, please contact your regional offices or the responsible personnel/channel to provide you with further technical details.
2. Please note WHEN ORDERING FRU PARTS, that you should check the most up-to-date information available on your regional web or channel. If, for whatever reason, a part number change is made, it will not be noted in the printed Service Guide. For ACER-AUTHORIZED SERVICE PROVIDERS, your Acer office may have a DIFFERENT part number code to those given in the FRU list of this printed Service Guide. You MUST use the list provided by your regional Acer office to order FRU parts for repair and service of customer machines.



<b>System Specifications</b>	<b>1</b>
Features .....	1
System Block Diagram .....	4
Your Acer Notebook tour .....	5
Front View .....	5
Closed Front View .....	6
Left View .....	7
Right View .....	8
Rear View .....	8
Bottom View .....	9
Indicators .....	10
Easy-Launch Buttons .....	10
Touch Pad Basics (with fingerprint reader) .....	11
Using the Keyboard .....	12
Lock Keys and embedded numeric keypad .....	12
Windows Keys .....	13
Hot Keys .....	14
Special Key .....	15
Using the System Utilities .....	16
Acer GridVista (dual-display compatible) .....	16
Launch Manager .....	17
Hardware Specifications and Configurations .....	18
 <b>System Utilities</b>	 <b>27</b>
BIOS Setup Utility .....	27
Navigating the BIOS Utility .....	27
Information .....	28
Main .....	29
Advanced .....	30
Security .....	32
Power .....	35
Boot .....	37
Exit .....	38
BIOS Flash Utility .....	39
Remove HDD/BIOS Utility .....	40
 <b>Machine Disassembly and Replacement</b>	 <b>43</b>
Disassembly Requirements .....	43
General Information .....	44
Pre-disassembly Instructions .....	44
Disassembly Process .....	44
External Module Disassembly Process .....	45
External Modules Disassembly Flowchart .....	45
Removing the Battery Pack .....	46
Removing the SD dummy card .....	47
Removing the ExpressCard dummy card .....	48
Removing the Lower Covers .....	49
Removing the DIMM Modules .....	50
Removing the MXM Module .....	51
Removing the Turbo RAM module .....	51
Removing the TV Tuner module .....	53
Removing the WLAN Module .....	54
Removing the Hard Disk Drive1 Module .....	55
Removing the Hard Disk Drive2 Module .....	58

# Table of Contents

Removing the Optical Drive Module	60
Main Unit Disassembly Process	62
Main Unit Disassembly Flowchart	62
Removing the Switch Cover	63
Removing the Switch Board	64
Removing the Keyboard	65
Removing the Modem Module	65
Removing the Antenna, MIC and Speaker Cables	67
Removing the LCD Module	69
Removing the Upper Cover	71
Removing the Touch Pad	75
Removing the Finger Print Reader	76
Removing the Launch Board	77
Removing the Speaker Module	79
Removing the eKey Module	79
Removing the Bluetooth board	81
Removing the Subwoofer Module	82
Removing the ExpressCard Module	83
Removing the Mainboard	85
Removing the CPU Fan Module	86
Removing the CPU	87
LCD Module Disassembly Process	89
LCD Module Disassembly Flowchart	89
Removing the LCD Bezel	90
Removing the Inverter Board	91
Removing the Camera Module	92
Removing the LCD Panel	93
Removing the LCD Brackets and FPC Cable	94
LCD Module Reassembly Procedure	96
Replacing the LCD Panel	96
Replacing the LCD Bezel	99
Main Module Reassembly Procedure	100
Replacing the CPU	100
Replacing the CPU Fan Module	100
Replacing the Mainboard	101
Replacing the Bluetooth Board	102
Replacing the ExpressCard Module	102
Replacing the Subwoofer Module	103
Replacing the Finger Print Reader	104
Replacing the eKey Module	106
Replacing the Touch Pad	107
Replacing the Launch Board	107
Replacing the Switch Board	108
Replacing the Antenna, MIC and Speaker Cables	109
Replacing the Speaker Module	111
Replacing the Upper Cover	111
Replacing the Modem Module	115
Replacing the Keyboard	116
Replacing the Switch Cover	117
Replacing the ODD Module	118
Replacing the Hard Disk Drive2 Module	119
Replacing the Hard Disk Drive1 Module	120
Replacing the WLAN Board	121
Replacing the TV Tuner Module	122
Replacing the Turbo Ram Module	123



# Table of Contents

Replacing the MXM Module	123
Replacing the DIMM Modules	124
Replacing the Lower Covers	124
Replacing the ExpressCard Dummy Tray	125
Replacing the SD Dummy Tray	125
Replacing the Battery	125
<b>Troubleshooting</b>	<b>127</b>
Common Problems	127
Power On Issue	128
No Display Issue	129
Random Loss of BIOS Settings	130
LCD Failure	131
Built-In Keyboard Failure	131
Touch Pad Failure	132
Internal Speaker Failure	132
Internal Microphone Failure	134
HDD Not Operating Correctly	135
ODD Failure	136
USB Failure (Rightside)	139
Modem Function Failure	139
Wireless Function Failure	140
EasyTouch Button Failure	140
MediaTouch Button Failure	141
Fingerprint Reader Failure	141
Thermal Unit Failure	142
HDTV Switch Failure	142
External Mouse Failure	143
Other Failures	143
Intermittent Problems	144
Undetermined Problems	144
POST Codes Tables	145
Chipset POST Codes	145
Core POST Codes	147
<b>Jumper and Connector Locations</b>	<b>155</b>
Top View	155
Bottom View	156
Clearing Password Check and BIOS Recovery	157
Clearing Password Check	157
BIOS Recovery by Crisis Disk	158
<b>FRU (Field Replaceable Unit) List</b>	<b>159</b>
Aspire 7730/7730G Exploded Diagrams	160
Upper Cover	160
Lower Cover	161
LCD Panel	162
<b>Model Definition and Configuration</b>	<b>170</b>
Aspire 7730/7730G Series	170
<b>Test Compatible Components</b>	<b>193</b>
Microsoft® Windows® Vista Environment Test	194
PCMCIA LAN Card Test	194
Express Card Test	194

# **Table of Contents**

Display Port Test .....	194
USB Port Test .....	194
Access Point Test .....	195
Bluetooth Test .....	195
Card Reader Test .....	196
Audio Jacks Port Test .....	196
Port Replicator Test .....	196
<b>Online Support Information</b>	<b>197</b>
<b>Index</b>	<b>199</b>

# System Specifications

---

## Features

Below is a brief summary of the computer's many feature:

### Operating System

- Windows® Vista™

### Platform

- Intel® Centrino® 2 processor technology, featuring:
  - Intel® Core™2 Duo processor\*
  - Mobile Intel® PM45/GM45 Express Chipset\*
  - Intel® Wireless WiFi Link 5100/5300, 5150/5350\*

### System Memory

- Dual-Channel DDR2 SDRAM support
- Up to 2 GB of DDR2 667 MHz memory, upgradeable to 4 GB using two soDIMM modules\*

### TV Tuner

- Digital TV-tuner supporting DVB-T\*

### Display and graphics

- 14.1" WXGA 1280 x 800
- Mobile Intel® GM45 Express Chipset
- NVIDIA GeForce 9300M GS / 9600M GT\*

### Storage subsystem

- 2.5" hard disk drive
- Optical drive options:
  - Blu-ray Disc™ /DVD-Super Multi double-layerdrive
  - DVD-Super Multi double-layer drive
- 5-in-1 card reader

### Audio

- Dolby-certified surround sound system with two built-in stereo speakers and one subwoofer supporting low-frequency effects
- S/PDIF (Sony/Philips Digital Interface) support for digital speakers
- Acer PureZone technology with two built-in stereo microphones

---

## Dimensions and Weight

- 340.4 (W) x 247 (D) x 22.9/42.3 (H) mm (13.4 x 9.7 x 0.9/1.6 inches)
- 2.4 kg (5.29 lbs.)

## Communication

- Acer Video Conference, featuring:
  - Integrated Acer Crystal Eye webcam
  - Acer Video Conference Manager software
  - Acer PureZone technology
  - Optional Acer Xpress VoIP phone
- WLAN: Intel® Wireless WiFi Link 5100/5300\*
- WiFi®/WiMAX™: Intel® Wireless WiFi Link 5150/5350\*
- WPAN: Bluetooth® 2.0+EDR (Enhanced Data Rate)
- LAN: Gigabit Ethernet; Wake-on-LAN ready
- Modem: 56K ITU V.92

## Privacy control

- Acer Bio-Protection fingerprint solution
- BIOS user, supervisor, HDD passwords
- Kensington lock slot

## Power subsystem

- ACPI 3.0
- 48.8 W 4400 mAh\*
- 3-pin 90 W AC adapter\*
- 3-pin 65 W AC adapter\*
- Energy Star 4.0

## Special keys and controls

- 88-/89-/93-key keyboard
- Touch Pad pointing device
- Empowering Key
- Easy-launch buttons: WLAN, Internet, email, Bluetooth, Acer Arcade™
- Acer MediaTouch keys: play/pause, stop, previous, next and record keys
- Volume wheel
- Acer Media Center remote control\*

## I/O interface

- Acer EasyPort IV connector
- ExpressCard™/54 slot
- 5-in-1 card reader (SD/MMC/MS/MS PRO/xD)

- 
- 3 USB 2.0 ports
  - HDMI™ port with HDCP support
  - Consumer infrared (CIR) port
  - External display (VGA) port
  - Headphones/speaker/line-out port with S/PDIF support
  - Microphone-in jack
  - Line-in jack
  - Ethernet (RJ-45) port
  - Modem (RJ-11) port
  - DC-in jack for AC adapter

## Environment

- Temperature:
  - Operating: 5 °C to 35 °C
  - Non-operating: -20 °C to 65 °C
- Humidity (non-condensing):
  - Operating: 20% to 80%
  - Non-operating: 20% to 80%

**NOTE:** Items marked with \* denote only selected models.

# System Block Diagram

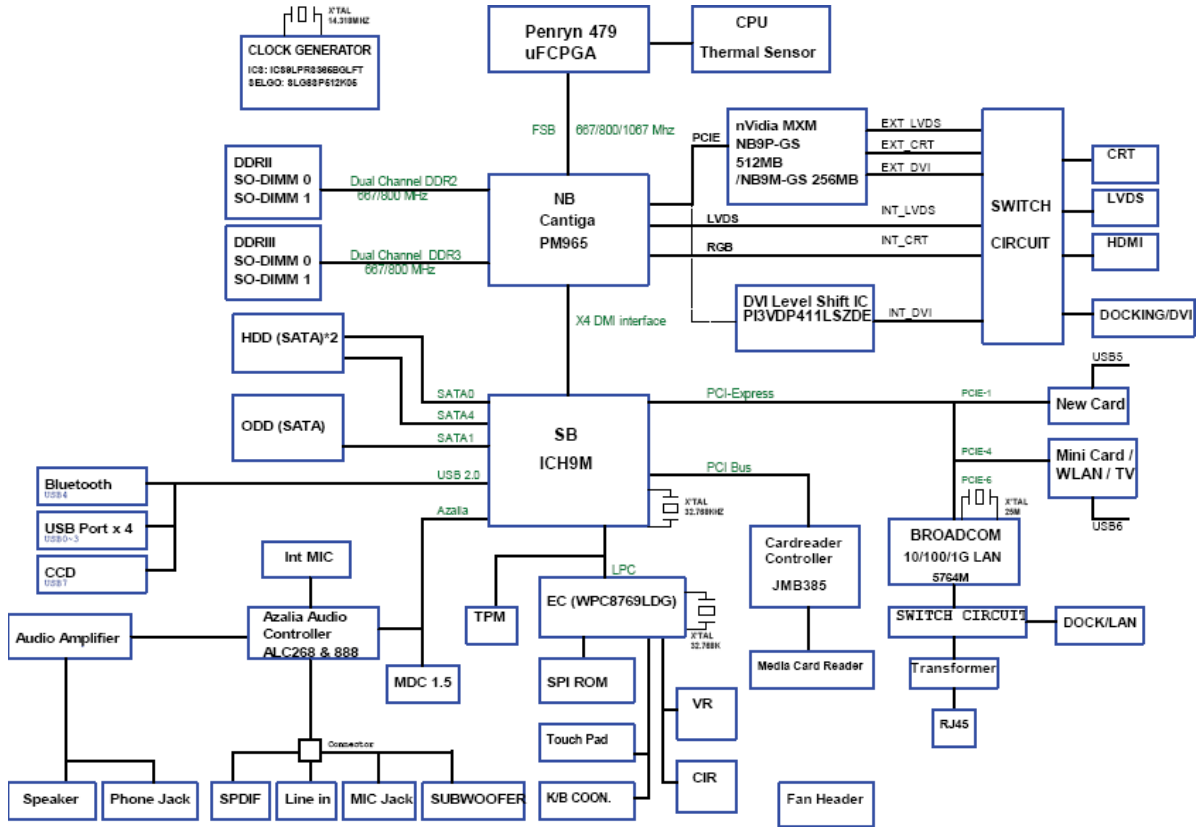



---

# Your Acer Notebook tour

After knowing your computer features, let us show you around your new computer.

## Front View





No.	Icon	Item	Description
1		Acer PureZone	Two internal stereo microphones for sound recording.
2		Acer Crystal Eye	Web camera for video communication.
3		Display screen	Also called Liquid-Crystal Display (LCD), displays computer output.
4		Status indicators	Light-Emitting Diodes (LEDs) that light up to show the status of the computer's functions and components.
5		Empowering key	Launch Acer Empowering Technology
6		Easy-launch buttons	Buttons for launching frequently used program.
7		Palmrest	Comfortable support area for your hands when you use the computer.
8		Touch Pad	Touch-sensitive pointing device which functions like a computer mouse.

No.	Icon	Item	Description
9		Click buttons (left, center* and right)	The left and right buttons function like the left and right mouse buttons. *The center button serves as Acer Bio-Protection fingerprint reader supporting Acer FingerNav 4-way control function.
10		Status indicators	Light-Emitting Diodes (LEDs) that light up to show the status of the computer's functions and components.
11		Keyboard	For entering data into your computer.
12		Speakers	Left and right speakers deliver stereo audio output.
13		Acer MediaTouch keys	For use with Acer Arcade and other media playing programs.
14		Power button	Turns the computer on and off.

## Closed Front View











No.	Icon	Item	Description
1		CIR receiver	Receives signals from a remote control.
2		5-in-1 card reader	Accepts Secure Digital (SD), MultiMediaCard (MMC), Memory Stick (MS), Memory Stick PRO (MS PRO), xD-Picture Card (xD).
3		Latch	Locks and releases the lid







## Left View



No.	Icon	Item	Description
1		Acer EasyPort IV connector	Connects to Acer EasyPort IV.
2		Ethernet (RJ-45) port	Connects to an Ethernet 10/100/1000-based network.
3		External display (VGA) port	Connects to a display device (e.g. external monitor, LCD projector).
4	HDMI	HDMI	Connects to a television or display device with HDMI input.
5		USB 2.0 ports	Connect to USB 2.0 devices (e.g. USB mouse, USB camera).
6		Line-in jack	Accepts audio line-in devices (e.g. audio CD player, stereo walkman).
7		Microphone-in jack	Accepts input from external microphones.
8		Headphones/speaker/line-out jack with S/PDIF support	Connects to audio line-out devices (e.g. speakers, headphones).
9		Unlimited volume control wheel	Adjust the volume of the audio-out.
10	ExpressCard / 54	ExpressCard/54 slot	Accepts one ExpressCard/54 module.

## Right View



No.	Icon	Item	Description
1		Kensington lock slot	Connects to a Kensington-compatible computer security lock.
2		Optical drive	Internal optical drive; accepts CDs or DVDs.
3		Optical disk access indicator	Lights up when the optical drive is active.
4		Optical drive eject button	Ejects the optical disk from the drive.
5		Emergency eject hole	Ejects the optical drive tray when the computer is turned off. <b>Note:</b> Insert a paper clip into the emergency eject hole to eject the optical drive tray when the computer is off.
6		Modem (RJ-11) port	Connects to a phone line.
7		USB 2.0 port	Connect to USB 2.0 devices (e.g. USB mouse, USB camera).
8		DC-in jack	Connects to an AC adapter

## Rear View







No.	Icon	Item	Description
1		Ventilation slots	Enable the computer to stay cool, even after prolonged use.

---





## Bottom View



No.	Icon	Item	Description
1		Battery bay	Houses the computer's battery pack.
2		Battery release latch	Releases the battery for removal.
3		Memory compartment	Houses the computer's main memory.
4		Hard disk bay	Houses the computer's hard disk (secured with screws).
5		Battery lock	Locks the battery in position.
6		Ventilation slots and cooling fan	Enable the computer to stay cool, even after prolonged use. <b>Note:</b> Do not cover or obstruct the opening of the fan.

## Indicators

The computer has several easy-to-read status indicators. The front panel indicators are visible even when the computer cover is closed.







Icon	Function	Description
	Power	Indicates the computer's power status.
	Battery	Indicates the computer's battery status.
	HDD	Indicates when the hard disk drive is active.
	Num Lock	Lights up when Num Lock is activated.
	Caps Lock	Lights up when Caps Lock is activated.

**NOTE:** 1. **Charging:** The light shows amber when the battery is charging. 2. **Fully charged:** The light shows green when in AC mode.

## Easy-Launch Buttons

Located beside the keyboard are application buttons. These buttons are called easy-launch buttons. They are: WLAN, Internet, email, Bluetooth, Arcade and Acer Empowering Technology.

The mail and Web browser buttons are pre-set to email and Internet programs, but can be reset by users. To set the Web browser, mail and programmable buttons, run the Acer Launch Manager.

Icon	Function	Description
	Empowering Technology	Launch Acer Empowering Technology. (user-programmable)
	Acer Arcade	Launch Acer Arcade utility
	Wireless communication button/indicator	Enables/disables the wireless function. Indicates the status of wireless LAN communication.
	Web browser	Internet browser (user-Programmable)
	Mail	Email application (user-Programmable)
	Bluetooth communication button/indicator	Enables/disables the Bluetooth function. Indicates the status of Bluetooth communication.

## Touch Pad Basics (with fingerprint reader)

The following items show you how to use the Touch Pad with Acer Bio-Protection fingerprint reader:

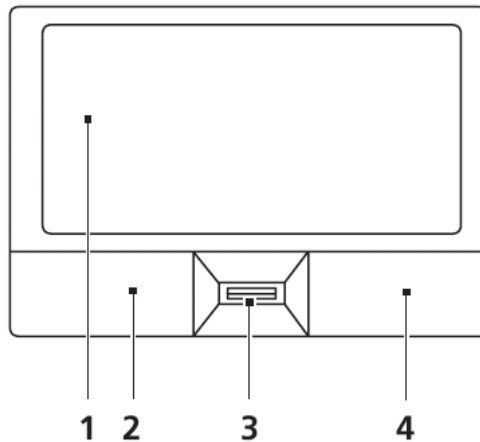

- Move your finger across the Touch Pad (2) to move the cursor.
- Press the left (1) and right (4) buttons located beneath the Touch Pad to perform selection and execution functions. These two buttons are similar to the left and right buttons on a mouse. Tapping on the Touch Pad is the same as clicking the left button.
- Use Acer Bio-Protection fingerprint reader (3) supporting Acer FingerNav 4-way control function (only for certain models) or the 4-way scroll (3) button (only for certain models) to scroll up or down and move left or right a page. This fingerprint reader or button mimics your cursor pressing on the right scroll bar of Windows applications.

Function	Left Button (1)	Right Button (3)	Main Touch Pad (2)
Execute	Quickly click twice.		Tap twice (at the same speed as double-clicking a mouse button).
Select	Click once.		Tap once.
Drag	Click and hold, then use finger on the Touch Pad to drag the cursor.		Tap twice (at the same speed as double-clicking a mouse button); rest your finger on the Touch Pad on the second tap and drag the cursor.
Access context menu		Click once.	

**NOTE:** When using the Touch Pad, keep it - and your fingers - dry and clean. The Touch Pad is sensitive to finger movement; hence, the lighter the touch, the better the response. Tapping too hard will not increase the Touch Pad's responsiveness.

---

# Using the Keyboard

The keyboard has full-sized keys and an embedded numeric keypad, separate cursor, lock, Windows, function and special keys.

## Lock Keys and embedded numeric keypad

The keyboard has three lock keys which you can toggle on and off.



















Lock key	Description
Caps Lock	When Caps Lock is on, all alphabetic characters typed are in uppercase.
Num Lock <Fn> + <F11>	When Num Lock is on, the embedded keypad is in numeric mode. The keys function as a calculator (complete with the arithmetic operators +, -, *, and /). Use this mode when you need to do a lot of numeric data entry. A better solution would be to connect an external keypad.
Scroll Lock <Fn> + <F12>	When Scroll Lock is on, the screen moves one line up or down when you press the up or down arrow keys respectively. Scroll Lock does not work with some applications.

The embedded numeric keypad functions like a desktop numeric keypad. It is indicated by small characters located on the upper right corner of the keycaps. To simplify the keyboard legend, cursor-control key symbols are not printed on the keys.

Desired access	Num Lock on	Num Lock off
Number keys on embedded keypad	Type numbers in a normal manner.	
Cursor-control keys on embedded keypad	Hold <Shift> while using cursor-control keys.	Hold <Fn> while using cursor-control keys.
Main keyboard keys	Hold <Fn> while typing letters on embedded keypad.	Type the letters in a normal manner.

# Windows Keys

The keyboard has two keys that perform Windows-specific functions.

Key	Description
 Windows key	<p>Pressed alone, this key has the same effect as clicking on the Windows Start button; it launches the Start menu. It can also be used with other keys to provide a variety of functions:</p> <ul style="list-style-type: none"> <li>&lt;  &gt;: Open or close the Start menu</li> <li>&lt;  &gt; + &lt;D&gt;: Display the desktop</li> <li>&lt;  &gt; + &lt;E&gt;: Open Windows Explore</li> <li>&lt;  &gt; + &lt;F&gt;: Search for a file or folder</li> <li>&lt;  &gt; + &lt;G&gt;: Cycle through Sidebar gadgets</li> <li>&lt;  &gt; + &lt;L&gt;: Lock your computer (if you are connected to a network domain), or switch users (if you're not connected to a network domain)</li> <li>&lt;  &gt; + &lt;M&gt;: Minimizes all windows</li> <li>&lt;  &gt; + &lt;R&gt;: Open the Run dialog box</li> <li>&lt;  &gt; + &lt;T&gt;: Cycle through programs on the taskbar</li> <li>&lt;  &gt; + &lt;U&gt;: Open Ease of Access Center</li> <li>&lt;  &gt; + &lt;X&gt;: Open Windows Mobility Center</li> <li>&lt;  &gt; + &lt;BREAK&gt;: Display the System Properties dialog box</li> <li>&lt;  &gt; + &lt;SHIFT+M&gt;: Restore minimized windows to the desktop</li> <li>&lt;  &gt; + &lt;TAB&gt;: Cycle through programs on the taskbar by using Windows Flip 3-D</li> <li>&lt;  &gt; + &lt;SPACEBAR&gt;: Bring all gadgets to the front and select Windows Sidebar</li> <li>&lt;CTRL&gt; + &lt;  &gt; + &lt;F&gt;: Search for computers (if you are on a network)</li> <li>&lt;CTRL&gt; + &lt;  &gt; + &lt;TAB&gt;: Use the arrow keys to cycle through programs on the taskbar by using Windows Flip 3-D</li> </ul> <p><b>Note:</b> Depending on your edition of Windows Vista, some shortcuts may not function as described.</p>
 Application key	<p>This key has the same effect as clicking the right mouse button; it opens the application's context menu.</p>

## Hot Keys

The computer employs hotkeys or key combinations to access most of the computer's controls like screen brightness, volume output and the BIOS utility.

To activate hot keys, press and hold the <Fn> key before pressing the other key in the hotkey combination.



Hotkey	Icon	Function	Description
<Fn> + <F1>	?	Hotkey help	Displays help on hotkeys.
<Fn> + <F2>		Acer eSettings Management	Launches Acer eSettings Management in Acer Empowering Technology.
<Fn> + <F3>		Acer ePower Management	Launches Acer ePower Management in Acer Empowering Technology.
<Fn> + <F4>	Z <sup>z</sup>	Sleep	Puts the computer in Sleep mode.
<Fn> + <F5>		Display toggle	Switches display output between the display screen, external monitor (if connected) and both.
<Fn> + <F6>		Screen blank	Turns the display screen backlight off to save power. Press any key to return.
<Fn> + <F7>		Touch Pad toggle	Turns the internal Touch Pad on and off.
<Fn> + <F8>		Speaker toggle	Turns the speakers on and off.
<Fn> + <▷>		Brightness up	Increases the screen brightness.
<Fn> + <◁>		Brightness down	Decreases the screen brightness.
<Fn> + <Home>		Play/Pause	Play/Pause the current media.
<Fn> + <Pg Up>		Stop	Stop the current media.
<Fn> + <Pg Dn>		Skip Backward	Skip to the next track of the current media.
<Fn> + <End>		Skip Forward	Skip to the previous track of the current media.



---

## Special Key

You can locate the Euro symbol and the US dollar sign at the upper-center and/or bottom-right of your keyboard.



### The Euro symbol

1. Open a text editor or word processor.
2. Hold <Alt Gr> and then press the <5> key at the upper-center of the keyboard.

**NOTE: Note:** Some fonts and software do not support the Euro symbol. Please refer to [www.microsoft.com/typography/faq/faq12.htm](http://www.microsoft.com/typography/faq/faq12.htm) for more information.

### The US dollar sign

1. Open a text editor or word processor.
2. Hold <Shift> and then press the <4> key at the upper-center of the keyboard.

**NOTE:** This function varies by the operating system version.

.

# Using the System Utilities

Acer Bio-Protection (only for certain models) Acer Bio-Protection Fingerprint Solution is a multi-purpose fingerprint software package integrated with the Microsoft Windows operating system. Utilizing the uniqueness of one's fingerprint features, Acer Bio-Protection Fingerprint Solution has incorporated protection against unauthorized access to your computer with centralized password management with Password Bank, easy music player launching with Acer MusicLaunch, secure Internet favorites via Acer MyLaunch, and fast application/website launching and login with Acer FingerLaunch, while Acer ProfileLaunch can launch up to three applications/websites from a single finger swipe.

Acer Bio-Protection Fingerprint Solution also allows you to navigate through web browsers and documents using Acer FingerNav. With Acer Bio-Protection Fingerprint Solution, you can now enjoy an extra layer of protection for your personal computer, as well as the convenience of accessing your daily tasks with a simple swipe of your finger!

For more information refer to the Acer Bio-Protection help files.



## Acer GridVista (dual-display compatible)

**NOTE:** This feature is only available on certain models.

To enable the dual monitor feature of the notebook, first ensure that the second monitor is connected, then select **Start, Control Panel, Display** and click on **Settings**. Select the secondary monitor (**2**) icon in the display box and then click the check box **Extend my windows desktop onto this monitor**. Finally, click **Apply** to confirm the new settings and click **OK** to complete the process.

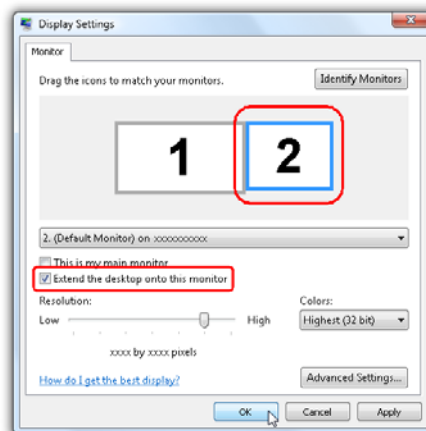

Acer GridVista is a handy utility that offers four pre-defined display settings so you can view multiple windows on the same screen. To access this function, please go to **Start → All Programs** and click on **Acer GridVista**. You may choose any one of the four display settings indicated below:



Double (vertical), Triple (primary at left), Triple (primary at right), or Quad Acer Gridvista is dual-display compatible, allowing two displays to be partitioned independently.

Acer Gridvista is dual-display compatible, allowing two displays to be partitioned independently.

AcerGridVista is simple to set up:

1. Run Acer GridVista and select your preferred screen configuration for each display from the task bar.
2. Drag and drop each window into the appropriate grid.
3. Enjoy the convenience of a well-organized desktop.

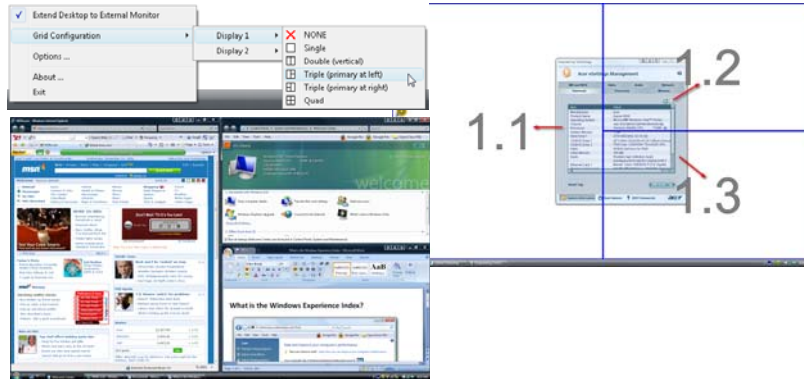

**NOTE:** Please ensure that the resolution setting of the second monitor is set to the manufacturer's recommended value.

## Launch Manager

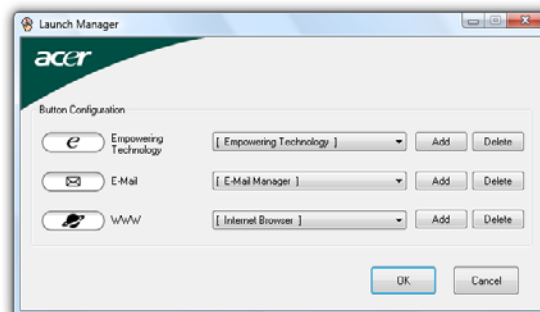

Launch Manager allows you to set the four easy-launch buttons located above the keyboard. You can access the Launch Manager by clicking on Start > All Programs > Launch Manager to start the application.

# Hardware Specifications and Configurations

## Processor

Item	Specification
CPU type	Intel® Penryn (dual core)
CPU package	Intel® 479 pin Micro-FCPGA
Features	<p>Supports Intel architecture with Dynamic execution.</p> <p>On-die, primary 32-kB instruction cache and 32-kB write-back data cache.</p> <p>On-die, up to 6MB second level shared cache with advanced transfer cache architecture.</p> <p>Streaming SIMD Extensions 2 (SSE2), Streaming SIMD Extensions 3 (SSE3) Supplemental streaming SIMD extensions 3 (SSSE3) and SSE4.1 instruction sets.</p> <p>1066MHz source-synchronous front side bus (FSB)</p> <p>Advanced power management features including Enhanced Intel SpeedStep® Technology and dynamic FSB frequency switching.</p> <p>Digital thermal sensor (DTS).</p> <p>Execute disable bit support for enhanced security.</p> <p>Intel® Dynamic Acceleration Technology and Enhanced Multi Threaded Thermal Management (EmTTM).</p> <p>Support enhanced Intel Virtualization Technology.</p>
CPU core voltage	VCC-CORE: Voltage for the future processor will depend on VID0-6 for battery mode and setting via software for adapter mode for the future processor

## North Bridge

Item	Specification
Type	Intel Crestline PM965 (North Bridge)
Package	FCBGA 1329 balls
Features	<p>Processor host bus supports, 667/800/1066MHz FSB support.</p> <p>Supports Dual Channel DDR2 SDRAM at 667/800 MHz.</p> <p>Supports Dual Channel DDR3 SDRAM at 800/1066 MHz.</p> <p>Integrated SDRAM controller up to 8GB (2 SODIMM support)</p> <p>External Graphics interface for PCI Express Architecture support</p> <p>DMI x2 and DMI x 4 for connection between GMCH and ICH9M</p> <p>Supports ACPI 3.0</p>
CPU core voltage	1.05V core, 1.5V, VCCSM(DDR2 = 1.8V/DDR3=1.5V), 2.5V, 3.3V

## South Bridge

Item	Specification
Type	ICH9M (South Bridge)
Package	BGA 676 balls

Item	Specification
Features	<p>Upstream accelerated Hub architecture interface for access to GMCH.</p> <p>PCI Express Base Specification, Revision 1.1 support.</p> <p>PCI 2.3 interface. (4 PCI Request/Grant pairs).</p> <p>ACPI Power Management Logic Support.</p> <p>Enhanced DMA controller, interrupt controller, timers functions.</p> <p>Integrated Serial ATA host controllers with independent DMA operation on six ports and AHCI support.</p> <p>USB 1.1 &amp; USB 2.0 Host controllers.</p> <p>Supports Intel High Definition Audio (Intel HD Audio) Interface.</p> <p>Supports Intel® Matrix Storage Technology.</p> <p>Supports Intel® Active Management Technology.</p> <p>Low Pin Count (LPC) interface.</p> <p>6 PCIe ports.</p>
CPU core voltage	1.05V core,1.5V,3.3V,5V CMOS I/O

#### CPU Fan True Value Table

CPU Temp (°C)	Fan Speed (rpm)
45	0
50	3000 ± 100
65	3400 ± 100
78	3800 ± 100
90	4200 ± 100

#### System Clock

Item	Specification
System clock chip	ICS9LPRS365BGLFT or pin compatible device
Package	64 pin TSSOP
Clock Synthesizer	<p>200/166Mhz for CPU, GMCH</p> <p>100MHz clock buffer for GMCH, ICH8M and PCI-E device, SATA, Docking station</p> <p>96MHz GMCH</p> <p>48Mhz for USB clock inside ICH8M</p> <p>33Mhz PCI clock for PCI device, LPC</p> <p>14.31818Mhz for ICH8M</p>
Power	3.3V
Features	<p>Support spread spectrum function, for reducing EMI</p> <p>Support SM bus interface.</p>

#### Crystal and Oscillator

Item	Specification
Features	<p>14.31818Mhz crystal for clock chip</p> <p>32.768Khz crystal for RTC inside ICH8M and WINBOND WPC8769LDG</p> <p>24.576Mhz for RICOH R5C833</p> <p>25MHZ crystal for BROADCOM Lan controller BCM5787.</p>

## System Memory

Item	Specification
Memory controller	Built-in
Memory size	0MB (no on-board memory)
DIMM socket number	2 sockets
Supports memory size per socket	2 GB
Supports maximum memory size	4G for 64bit OS (with two 2GB SODIMM)
Supports DIMM type	DDR II 677 Mhz /DDR III 1066 MHz SDRAM memory interface design
Supports DIMM Speed	667/1066 MHz
Memory module combinations	You can install memory modules in any combinations as long as they match the above specifications.

## Memory Combinations

Slot 1	Slot 2	Total Memory
0MB	256MB	256MB
0MB	512MB	512MB
0MB	1024MB	1024MB
0MB	2048MB	2048MB
256MB	256MB	512MB
256MB	512MB	768MB
256MB	1024MB	1280MB
256MB	2048MB	2304MB
512MB	256MB	768MB
512MB	512MB	1024MB
512MB	1024MB	1536MB
512MB	2048MB	2560MB
1024MB	0MB	1024MB
1024MB	256MB	1280MB
1024MB	512MB	1536MB
1024MB	1024MB	2048MB
1024MB	2048MB	3072MB
2048MB	0MB	2048MB
2048MB	256MB	2304MB
2048MB	512MB	2560MB
2048MB	1024MB	3072MB
2048MB	2048MB	4096MB

## Hard Disk Drive Interface

Item				
Vendor & Model Name				
Capacity (MB)				
Bytes per sector				

Item				
Data heads				
Drive Format				
Disks				
Spindle speed (RPM)				
Performance Specifications				
Buffer size				
Interface				
Max. media transfer rate (disk-buffer, Mbytes/s)				
Data transfer rate (host~buffer, Mbytes/s)				
DC Power Requirements				
Voltage tolerance				

### Combo Drive Module

Item	Specification
Vendor & model name	
Performance Specification	
Transfer rate (KB/sec)	
Buffer Memory	
Interface	
Applicable disc format	
Loading mechanism	
Power Requirement	
Input Voltage	

### Thermal Sensor Control

Item	Specification
Thermal Sensor Chip	GMT-780 / LM95245
Package	8-pin MSOP
Features	Thermal sensor control Interface
Interface	I <sup>2</sup> C bus, address: 98h

### BIOS

Item	Specification
BIOS vendor	Phoenix BIOS code
BIOS Version	
BIOS ROM type	Serial Flash Memory
BIOS ROM size	1MB

Item	Specification
BIOS package	8 pins SOIC
Supported protocols	
BIOS password control	Set by setup manual

#### LCD 15.4"

Item	Specification
Vendor/model name	
Screen Diagonal (mm)	15.4 TFT WXGA, 220nits, 8ms
Active Area (mm)	
Display resolution (pixels)	
Pixel Pitch	
Pixel Arrangement	
Display Mode	
Typical White Luminance (cd/m <sup>2</sup> ) also called Brightness	
Luminance Uniformity	
Contrast Ratio	
Response Time (Optical Rise Time/Fall Time) msec	
Nominal Input Voltage VDD	
Typical Power Consumption (watt)	
Weight (without inverter)	
Physical Size (mm)	
Electrical Interface	
Support Color	
Viewing Angle (degree) Horizontal: Right/Left Vertical: Upper/Lower	
Temperature Range (°C) Operating Storage (shipping)	

#### VGA Subsystem

Item	Specification
Chipset	Nvidia NB9P-GS with 512M VRAM or NB9M-GS with 256M VRAM
Package	MXM



Item	Specification
Features	Unified Shader Architecture Support Microsoft® DirectX® 10 Shader Model 4 Geometry Instancing 2.0 SGI OpenGL® 2.0 Optimizations and support Adaptive PCI Express Interface High efficiency integrated adaptable and programmable Video Processor (VP2) Integrated Bit Stream Processor (BSP) NVIDIA PureVideo/Pure Video HD Technology Industry Video codec standard hardware acceleration Advanced Spatial Temporal De-Interlacing Vibrant Color Temperature Correction LCD Overdrive High-Quality Real-Time Video Recording Best quality 10-bit display pipeline NVIDIA nView Multi Display Technology SmartDimmer Technology Integrated HDMI Support Support for integrated HDCPNVIDIA Digital Vibrance Control Technology Integrate HDTV Encoder Dual 400MHz RAMDACs
Power	1.0V core, 1.2V, 3.3V, 2.5V, 1.8V

**KBC**

Item	Specification
Chipset	WINBOND WPCE775CA0DG
Features	Host interface, base on Intel's LPC Interface specification Revision 1.0 PC01 REV 1.0 and ACPI 3.0 compliant Supports Microsoft® Advanced Power Management (APM) Specifications Rev 1.2 Share BIOS flash memory Support for SPI flash memories Host-controlled CIR Port High-accuracy, high-speed ADC Up to 84 GPIO ports (including keyboard scanning) with a variety of wake-up events. 16-bit RISC core, with up to 4 Mbytes of external address space, and running at up to 25 MHZ 128 pin LQFP package

### Memory Card Reader

Item	Specification
Type	JMicron JMB385
Features	Support 5-in-1 Card Reader (MS,MS pro, SD, MMC, xD) Compliant with SD Memory Card Specification Version 2.0 Compliant with MultiMediaCard Specification Version 4.1 Compliant with Memory Stick Standard Format Specification Version 1.4 Compliant with Memory Stick PRO Format Specification Version 1.00 Compliant with xD Picture Card Specification Version 1.20 Compliant with xD Picture Card Host Guideline Version 1.20

### CIR

Item	Specification
Type	EVERLIGHT BEBK0075Z00
Features	Low voltage and low power consumption. Suitable burst length 10 pulses/burst.

### Audio Interface

Item	Specification
Audio Controller	Realtek ALC888 Azadia Codec and Amplifier GMT G1412 + G1411
Features	HD Audio 97dB SNR DACs & 90dB SNR ADCs Ten DAC channels support 16/20/24-bit PCM format for 7.1 sound playback, plus 2 channels of independent stereo sound output (multiple streaming) through the front panel output Two stereo ADCs support 16/20/24-bit PCM format, one for stereo microphone, one for legacy mixer recording All DACs supports 44.1k/48k/96k/192kHz sample rate All ADCs support 44.1k/48k/96k sample rate Two independent 16/20/24-bit S/PDIF-OUT converters support 44.1k/48k/96k/192kHz sample rate, one for nominal digital audio, the other one for digital audio output to HDMI transmitter Enable VoIP function Subwoofer support

### LAN Interface

Item	Specification
LAN Chipset	Broadcom 5764M
Features	Integrated 10/100/1000 BASE -T transceiver PCIe V1.1 compliant Wake on LAN support meeting the ACPI requirements 68pin-QFN package

### Bluetooth Interface

Item	Specification
Chipset	FOXCON T60H928.11 Bluetooth miniUSB module
Features	Internal Mini USB solution with antenna Bluetooth 2.0+EDR Bluetooth control for BT optical mouse

### Keyboard

Item	Specification
Type	Aspire series: New Acer Non-Ergo Keyboard
Total number of keypads	88-/89-/93-key
Windows logo key	Yes
Internal & external keyboard work simultaneously	Plug USB keyboard to the USB port directly: Yes

### MDC Card

Item	Specification
Chipset	Intel® Wireless WiFi Link 5100/5300
Features	<ul style="list-style-type: none"><li>• ITU-T V.92, V.90 Data Mode with auto-fallback to, V.34, V.32terbo, and V.32bis.</li><li>• V.42 LAPM and MNP 2-4 error correction.</li><li>• V.44, V.42bis and MNP 5 data compression.</li><li>• Send and receive rates up to 14400bps, support ITU-T V.17, V.29, V.27ter, and V.21 Ch2 fax.</li><li>• TIA/EIA 602 Standard for AT command set, and Fax TIA/EIA 578 Class 1 command set.</li><li>• DTMF and call progress monitor.</li></ul>

### Camera

Item	Specification
Type	0.3M pixel camera module

### Finger Print Board

Item	Specification
Features	TruePrint® and TrueMatch® Technology. TrueNav® Cursor and Menu Navigation Technology High Definition 128 x 8 Pixel Array Multiple battery-friendly operating modes @ 3.3V Built-in low power Finger Detection w/ remote wakeup capability USB 2.0 Full Speed Interface

### Battery

Item	Specification
Vendor & model name	SANYO/Sony/ SIMPLO/ PANASONIC
Battery Type	Li-ion
Pack capacity	4000/4800 mAh
Number of battery cell	6/8
Package configuration	3S2P/4S2PI

---

Item	Specification
Normal voltage	11.1V
Charge voltage	16.0V

# System Utilities

---

## BIOS Setup Utility

The BIOS Setup Utility is a hardware configuration program built into your computer's BIOS (Basic Input/Output System).

Your computer is already properly configured and optimized, and you do not need to run this utility. However, if you encounter configuration problems, you may need to run Setup. Please also refer to Chapter 4 Troubleshooting when problem arises.

To activate the BIOS Utility, press **F2** during POST (when "Press <F2> to enter Setup" message is prompted on the bottom of screen).

Press **F2** to enter setup. The default parameter of F12 Boot Menu is set to "disabled". If you want to change boot device without entering BIOS Setup Utility, please set the parameter to "enabled".

Press <F12> during POST to enter multi-boot menu. In this menu, user can change boot device without entering BIOS SETUP Utility.

## Navigating the BIOS Utility

There are six menu options: Information, Main, Advanced, Security, Boot, and Exit.

Follow these instructions:

- To choose a menu, use the left and right arrow keys.
- To choose an item, use the up and down arrow keys.
- To change the value of a parameter, press **F5** or **F6**.
- A plus sign (+) indicates the item has sub-items. Press **Enter** to expand this item.
- Press **Esc** while you are in any of the menu options to go to the Exit menu.
- In any menu, you can load default settings by pressing **F9**. You can also press **F10** to save any changes made and exit the BIOS Setup Utility.

**NOTE:** You can change the value of a parameter if it is enclosed in square brackets. Navigation keys for a particular menu are shown on the bottom of the screen. Help for parameters are found in the Item Specific Help part of the screen. Read this carefully when making changes to parameter values. **Please note that system information is subject to different models.**

## Information

The Information screen displays a summary of your computer hardware information.

InsydeH20 Setup Utility						Rev. 3.5
Information	Main	Advanced	Security	Power	Boot	Exit
CPU Type:	Intel (R) Core (TM)2 Duo CPU @ 2.40GHz					
CPU Speed:	2.40GHz					
HDD Model Name:	Hitachi HTS543516K9SA00					
HDD Serial Number:	071129BB0C02WGHDKKGC					
ATAPI Model Name:	Slimtype DVD A DS8A2S					
System BIOS Version:	V0.15T2					
VGA BIOS Version:	Intel V1588					
Serial Number:						
Asset Tag Number:						
Product Name:	Aspire 4930					
Manufacturer Name:	Acer					
UUID:	864BD4BE-6B22-5843-38D2-001B38D637FC					
F1 Help	↑↓ Select Item	F5/F6 Change Item	F9 Setup Default			
ESC Exit	←→ Select Menu	Enter Select▶ Submenu	F10 Save and Exit			

**NOTE:** The system information is subject to different models.

Parameter	Description
CPU Type	This field shows the CPU type and speed of the system.
CPU Speed	This field shows the speed of the CPU.
HDD Model Name	This field shows the model name of HDD installed on primary IDE master.
HDD Serial Number	This field displays the serial number of HDD installed on primary IDE master.
ATAPI Model Name	This field shows the model name of the Optical device installed in the system.
System BIOS Version	Displays system BIOS version.
VGA BIOS Version	This field displays the VGA firmware version of the system.
Serial Number	This field displays the serial number of this unit.
Asset Tag Number	This field displays the asset tag number of the system.
Product Name	This field shows product name of the system.
Manufacturer Name	This field displays the manufacturer of this system.
UUID Number	Universally Unique Identifier (UUID) is an identifier standard used in software construction, standardized by the Open Software Foundation (OSF) as part of the Distributed Computing Environment (DCE).

# Main

The Main screen allows the user to set the system time and date as well as enable and disable boot option and recovery.

InsydeH20 Setup Utility						Rev. 3.5
Information	Main	Advanced	Security	Power	Boot	Exit
System Time			[13:04:04]			Item Specific Help
System Date			[04/21/2008]			This is the help for the hour field. Valid range is from 0 to 23. INCREASE/REDUCE : F5/F6
Total Memory			3017 MB			
Video Memory			[32MB]			
Quick Boot			[Enabled]			
Network Boot			[Enabled]			
F12 Boot Menu			[Disabled]			
D2D Recovery			[Enabled]			
SATA Mode			[ACHI]			
F1 Help	↑↓ Select Item		F5/F6 Change Item			F9 Setup Default
ESC Exit	←→ Select Menu		Enter Select▶ Submenu			F10 Save and Exit

**NOTE:** The screen above is for your reference only. Actual values may differ.

The table below describes the parameters in this screen. Settings in **boldface** are the default and suggested parameter settings.

Parameter	Description	Format/Option
System Time	Sets the system time. The hours are displayed with 24-hour format.	Format: HH:MM:SS (hour:minute:second)
System Date	Sets the system date.	Format MM/DD/YYYY (month/day/year)
Total Memory	This field reports the memory size of the system. Memory size is fixed to 3017 MB.	N/A
Video Memory	Shows the video memory size. VGA Memory size=32 MB	N/A
Quick Boot	Allows startup to skip certain tests while booting, decreasing the time needed to boot the system.	Option: <b>Enabled</b> or Disabled
Network Boot	Enables, disables the system boot from LAN (remote server).	Option: <b>Enabled</b> or Disabled
F12 Boot Menu	Enables, disables Boot Menu during POST.	Option: <b>Disabled</b> or Enabled
D2D Recovery	Enables, disables D2D Recovery function. The function allows the user to create a hidden partition on hard disc drive to store operation system and restore the system to factory defaults.	Option: <b>Enabled</b> or Disabled
SATA Mode	Control the mode in which the SATA controller should operate.	Option: <b>AHCI Mode</b> or IDE Mode

**NOTE:** The sub-items under each device will not be shown if the device control is set to disable or auto. This is because the user is not allowed to control the settings in these cases.

# Advanced

The Advanced screen allows the user to configure the various advanced BIOS options.

**IMPORTANT:** Making incorrect settings to items on these pages may cause the system to malfunction. Unless you have experience adjusting these items, we recommend that you leave these settings at the default values. If making settings to items on these pages causes your system to malfunction or prevents the system from booting, open BIOS and choose Load Optimal Defaults in the Exit menu to boot up normally.

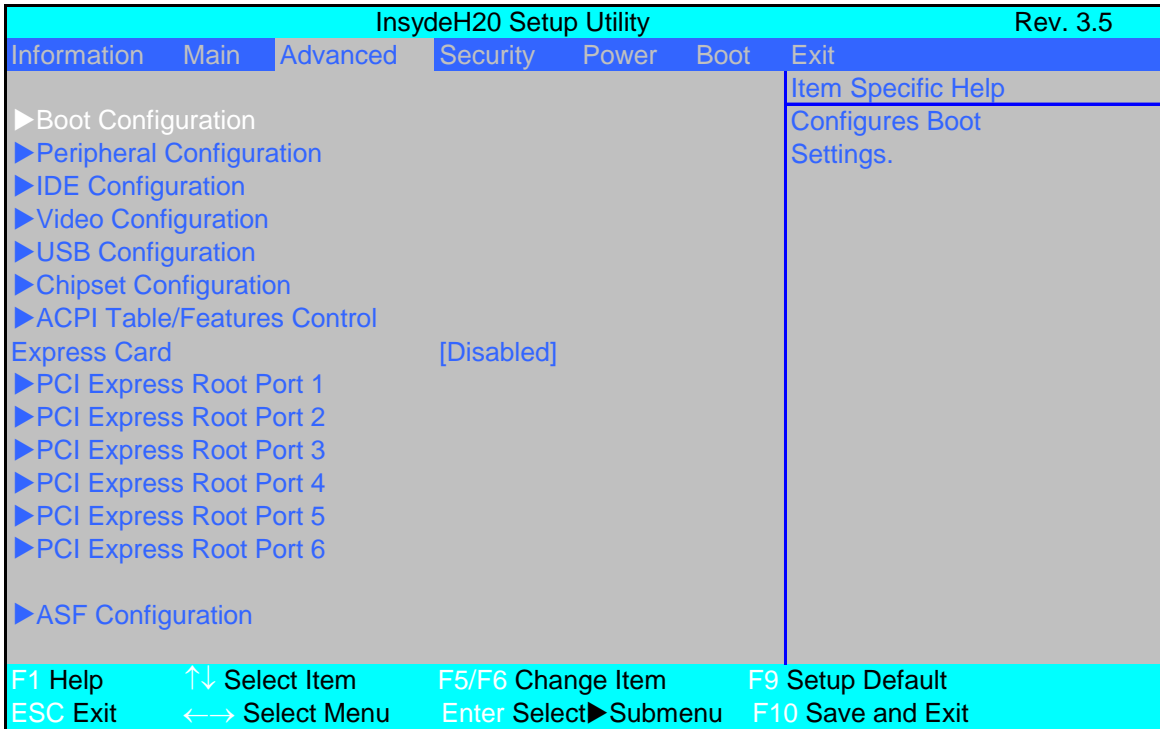

The table below describes the items, menus, and submenus in this screen. Settings in **boldface** are the default and suggested parameter settings.

Parameter	Description	Submenu Items
Boot Configuration	Enter the Boot Configuration menu.	<ul style="list-style-type: none"> <li>Numlock</li> <li>Zip Emulation Type</li> </ul>
Peripheral Configuration	Enter the Peripheral Configuration menu.	<ul style="list-style-type: none"> <li>Serial Port A</li> <li>Infrared Port</li> <li>Azalia</li> <li>LAN</li> </ul>
IDE Configuration	Enter the IDE Configuration menu.	<ul style="list-style-type: none"> <li>IDE Controller</li> <li>HDC Configure as</li> <li>ACHI Option ROM Support</li> <li>SATA Port 0, 1, 4, and 5 Hotplug</li> <li>Channel 1 to 4 Master and Slave</li> </ul>
Video Configuration	Enter the Video Configuration menu.	<ul style="list-style-type: none"> <li>IGD Device2, Function1</li> <li>IGD Pre-allocate Memory</li> <li>IGD DVMT Size</li> <li>Clock Chip Intialize</li> <li>Enabled CK SSC</li> <li>IGD Boot Type</li> <li>IGD LCD Panel Type</li> <li>IGD TV</li> </ul>



Parameter	Description	Submenu Items
USB Configuration	Enter the USB Configuration menu.	<ul style="list-style-type: none"> <li>• USB Driver Select</li> <li>• EHCI 1 and 2</li> <li>• UHCI 1 to 5</li> <li>• Per-Port Control</li> </ul>
Chipset Configuration	Enter the Chipset Configuration menu.	<ul style="list-style-type: none"> <li>• Port 80h Cycles</li> <li>• DMI Link ASPM Control</li> <li>• PCI Latency Timer</li> <li>• VT-d</li> </ul>
ACPI Table/ Features Control	Enter the ACPI Table/Features Control menu.	<ul style="list-style-type: none"> <li>• FACP C2 Latency Value</li> <li>• FACP C3 Latency Value</li> <li>• FACP RTC S4 Wakeup</li> <li>• APIC IO APIC Mode</li> <li>• HPET Support</li> <li>• Base Address Select</li> </ul>
Express Card	<b>Disable</b> or Enable the Express Card solution for windows Standby and Hibernation.	N/A
PCI Express Root Port 1 to 6	Enter the PCI Port 1 to 6 configuration menus.	<ul style="list-style-type: none"> <li>• VC1 Enable</li> <li>• ASPM</li> <li>• URR</li> <li>• FER</li> <li>• NFER</li> <li>• CER</li> <li>• CTO</li> <li>• SEFE</li> <li>• SENFE</li> <li>• SECE</li> <li>• PME Interrupt</li> <li>• PME SCI</li> <li>• Hot Plug SCI</li> </ul>
ASF Configuration	Enter the ASF Configuration menu.	<ul style="list-style-type: none"> <li>• Mini Watchdog Timeout</li> <li>• BIOS Boot Timeout</li> <li>• OS Boot Timeout</li> <li>• Power-on wait time</li> </ul>

# Security

The Security screen contains parameters that help safeguard and protect your computer from unauthorized use.

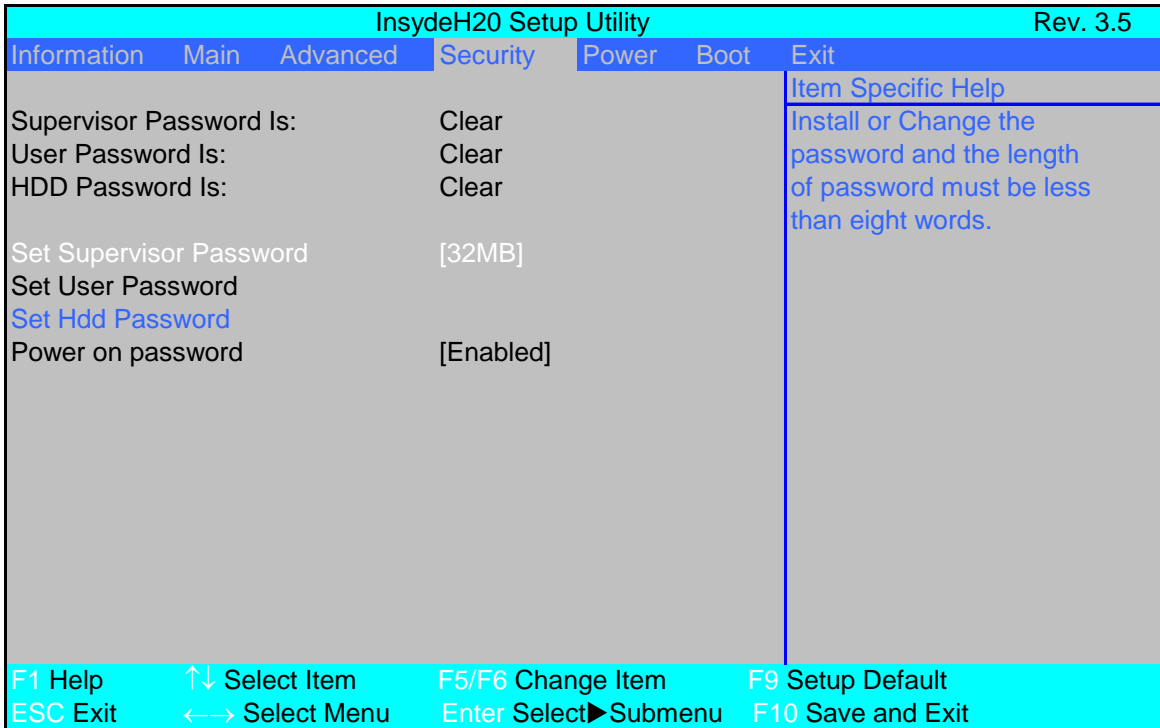

The table below describes the parameters in this screen. Settings in **boldface** are the default and suggested parameter settings.

Parameter	Description	Option
Supervisor Password Is	Shows the setting of the Supervisor password	<b>Clear</b> or Set
User Password Is	Shows the setting of the user password.	<b>Clear</b> or Set
HDD Password Is	Shows the setting of the hard disk password.	<b>Clear</b> or Set
Set Supervisor Password	Press Enter to set the supervisor password. When set, this password protects the BIOS Setup Utility from unauthorized access. The user can not either enter the Setup menu nor change the value of parameters.	
Set User Password	Press Enter to set the user password. When user password is set, this password protects the BIOS Setup Utility from unauthorized access. The user can enter Setup menu only and does not have right to change the value of parameters.	
Set HDD Password	Enter HDD Password.	
Password on Boot	Defines whether a password is required or not while the events defined in this group happened. The following sub-options are all requires the Supervisor password for changes and should be grayed out if the user password was used to enter setup.	<b>Disabled</b> or Enabled

**NOTE:** When you are prompted to enter a password, you have three tries before the system halts. Don't forget your password. If you forget your password, you may have to return your notebook computer to your dealer to reset it.

---

## Setting a Password

Follow these steps as you set the user or the supervisor password:

1. Use the ↑ and ↓ keys to highlight the Set Supervisor Password parameter and press the **Enter** key. The Set Supervisor Password box appears:

Set Supervisor Password		
Enter New Password	[	]
Confirm New Password	[	]

2. Type a password in the “Enter New Password” field. The password length can not exceeds 8 alphanumeric characters (A-Z, a-z, 0-9, not case sensitive). Retype the password in the “Confirm New Password” field.

**IMPORTANT:** Be very careful when typing your password because the characters do not appear on the screen.

3. Press **Enter**. After setting the password, the computer sets the User Password parameter to “Set”.
4. If desired, you can opt to enable the Password on boot parameter.
5. When you are done, press F10 to save the changes and exit the BIOS Setup Utility.

## Removing a Password

Follow these steps:

1. Use the ↑ and ↓ keys to highlight the Set Supervisor Password parameter and press the **Enter** key. The Set Password box appears:

Set Supervisor Password		
Enter current password	[	]
Enter New Password	[	]
Confirm New Password	[	]

2. Type the current password in the Enter Current Password field and press **Enter**.
3. Press **Enter** twice **without** typing anything in the Enter New Password and Confirm New Password fields. The computer then sets the Supervisor Password parameter to “Clear”.
4. When you have changed the settings, press u to save the changes and exit the BIOS Setup Utility.

---

## Changing a Password

1. Use the ↑ and ↓ keys to highlight the Set Supervisor Password parameter and press the **Enter** key. The Set Password box appears.

Set Supervisor Password		
Enter current password	[	]
Enter New Password	[	]
Confirm New Password	[	]

2. Type the current password in the Enter Current Password field and press **Enter**.
3. Type a password in the Enter New Password field. Retype the password in the Confirm New Password field.
4. Press **Enter**. After setting the password, the computer sets the User Password parameter to “Set”.
5. If desired, you can enable the Password on boot parameter.
6. When you are done, press F10 to save the changes and exit the BIOS Setup Utility.

If the verification is OK, the screen will display as following.

Setup Notice
Changes have been saved.
[ continue]

The password setting is complete after the user presses **Enter**.

If the current password entered does not match the actual current password, the screen will show you the Setup Warning.

Setup Warning
Invalid password
Re-enter Password
[ continue]

If the new password and confirm new password strings do not match, the screen will display the following message.

Setup Warning
Password do not match
Re-enter Password

# Power

The Power screen allows the user to configure various CPU and power management options and device wakeup behavior.

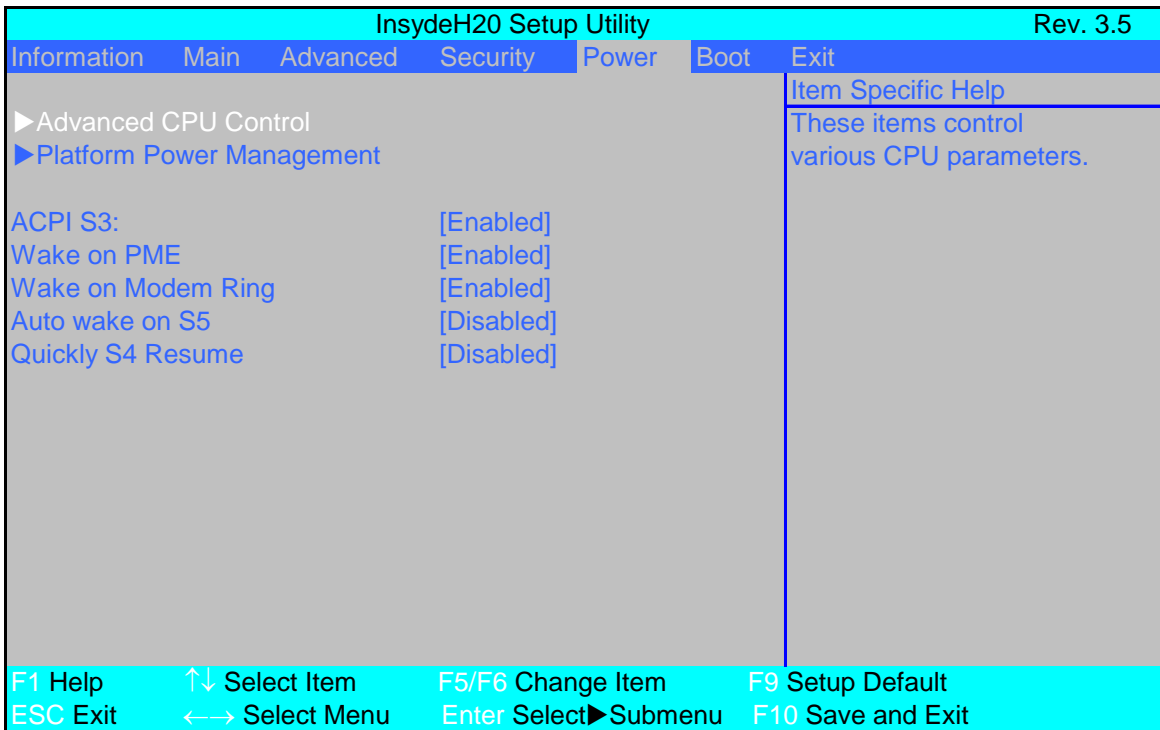

The table below describes the items, menus, and submenus in this screen. Settings in **boldface** are the default and suggested parameter settings.

Parameter	Description	Submenu Items
Advanced CPU Control	Enter the Advanced CPU Control menu.	<ul style="list-style-type: none"> <li>• P-States (IST)</li> <li>• Boot performance mode</li> <li>• Thermal Mode</li> <li>• CMP Support</li> <li>• Use XD capability</li> <li>• VT Support</li> <li>• C-States</li> <li>• Enhanced C-States</li> <li>• C-State Pop Up Mode</li> <li>• C-State Pop Down Mode</li> <li>• C4 Exit Timing Mode</li> <li>• DeepC4</li> <li>• Hard C4E</li> <li>• Enable C6</li> <li>• EMTTM</li> <li>• Bi-directional PROCHOT#</li> <li>• Dynamic FSB Switching</li> <li>• Turbo Mode</li> <li>• ACPI 3.0 T-States</li> <li>• DTS</li> <li>• DTS Calibration</li> <li>• Thermal Trip Points Setting (Fan On Temp., Throttle On Temp.)</li> </ul>

Parameter	Description	Submenu Items
Platform Power management	Enter the Platform Power Management menu.	<ul style="list-style-type: none"> <li>• PCI Clock Run</li> <li>• _CST - C4 Latency Value</li> <li>• C4 on C3 - Deeper Sleep</li> </ul>
ACPI S3	<b>Enable</b> or Disable ACPI S1/S3 Sleep State	N/A
Wake on PME	<b>Enable</b> or Disable wake up when the system power is off and a PCI Power Management Enable wake up event occurs.	N/A
Wake on Modem Ring	<b>Enable</b> or Disable wake up when the system power is off and a modem attached to the serial port is ringing.	N/A
Auto wake on S5	<b>Disable</b> or Enable auto wake up by date and time or at a fixed time everyday.	N/A
Quickly S4 Resume	Disable or Enable optional quick boot from S4 Resume.	N/A

## Boot

This menu allows the user to decide the order of boot devices to load the operating system. Bootable devices includes the USB diskette drives, the onboard hard disk drive and the DVD drive in the module bay.

InsydeH20 Setup Utility				Rev. 3.5		
Information	Main	Advanced	Security	Power	Boot	Exit
Boot priority order:						Item Specific Help
1. IDE0 : Hitachi HTS542516K9SA00						Use <↑> or <↓> to select a device, then press <F5> to move it down the list, or <F6> to move it up the list. Press <Esc> to escape the menu
2. IDE1 : Slimtype DVD A DS8A2S						
3 . USB FDD :						
4. Network Boot : Realtek Boot Agent						
5. USB HDD :						
6. USB CDROM :						
F1 Help	↑↓ Select Item	F5/F6 Change Item	F9 Setup Default			
ESC Exit	←→ Select Menu	Enter Select▶ Submenu	F10 Save and Exit			

# Exit

The Exit screen allows you to save or discard any changes you made and quit the BIOS Utility.

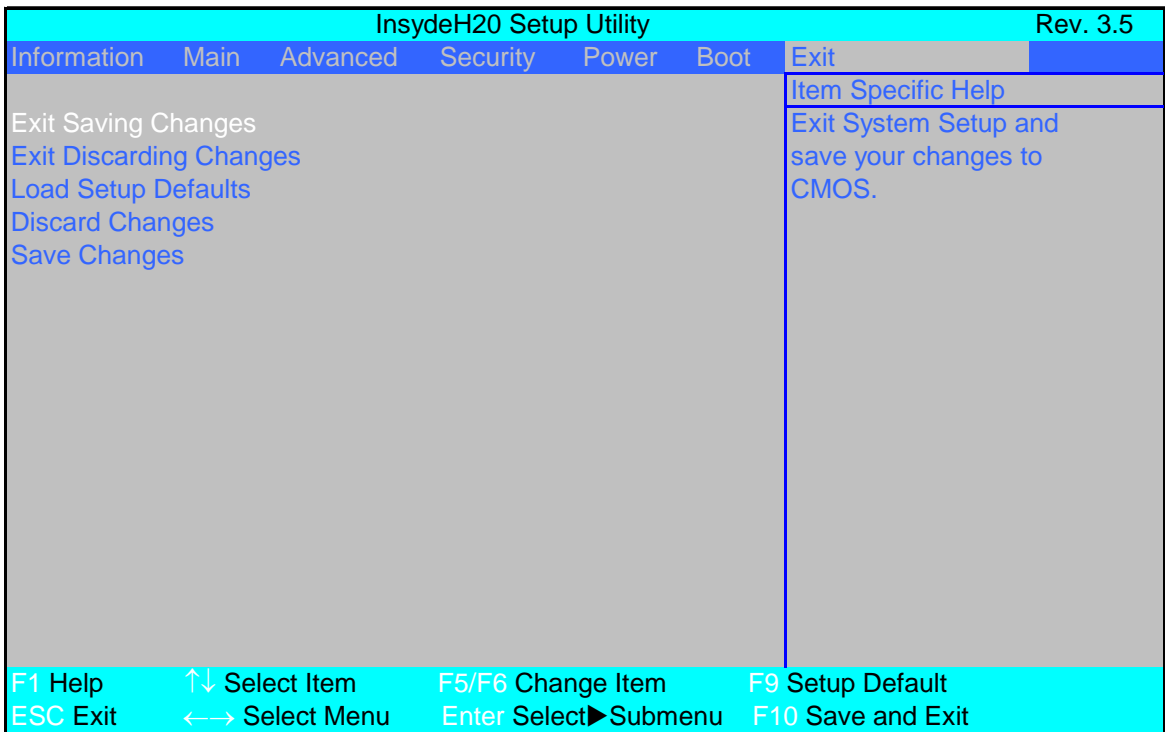

The table below describes the parameters in this screen.

Parameter	Description
Exit Saving Changes	Exit System Setup and save your changes to CMOS.
Exit Discarding Changes	Exit utility without saving setup data to CMOS.
Load Setup Default	Load default values for all SETUP item.
Discard Changes	Load previous values from CMOS for all SETUP items.
Save Changes	Save Setup Data to CMOS.



---

# BIOS Flash Utility

The BIOS flash memory update is required for the following conditions:

- New versions of system programs
- New features or options
- Restore a BIOS when it becomes corrupted.

Use the Phlash utility to update the system BIOS flash ROM.

**NOTE:** If you do not have a crisis recovery diskette at hand, then you should create a **Crisis Recovery Diskette** before you use the Phlash utility.

**NOTE:** Do not install memory-related drivers (XMS, EMS, DPMI) when you use the Phlash.

**NOTE:** Please use the AC adaptor power supply when you run the Phlash utility. If the battery pack does not contain enough power to finish BIOS flash, you may not boot the system because the BIOS is not completely loaded.

Follow the steps below to run the Phlash.

1. Prepare a bootable diskette.
2. Copy the flash utilities to the bootable diskette.
3. Then boot the system from the bootable diskette. The flash utility has auto-execution function.

# Remove HDD/BIOS Utility

This section provide you with removing HDD/BIOS method:

## Remove HDD Password:

- If you key in wrong HDD password three times, HDD password error code displays. See the image below.



To reset the HDD password, run HDD\_PW.EXE as follows:

1. Key in **hdd\_pw 15494 0**
2. Press 2.
3. Select one upper-case string from the list.



4. Reboot system and key in the selected string (0KJFN42 or UVEIQ96) on the HDD User Password screen.



### Remove BIOS Password:

If you key in the wrong Supervisor Password three times, System Disabled displays on the screen. See the image below.

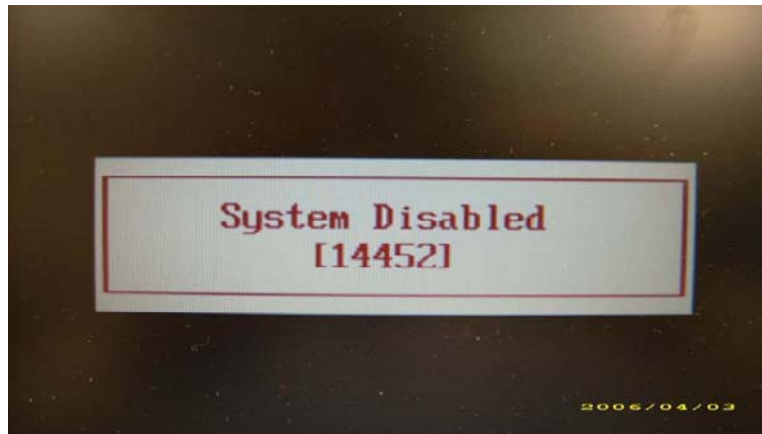

To reset the BIOS password, run BIOS\_PW.EXE as follows:

1. Key in **bios\_pw 14452 0**
2. Select one string from the list.

```
C:\WINDOWS\system32\cmd.exe
Microsoft Windows XP [Version 5.1.2600]
Copyright 1985-2001 Microsoft Corp.
C:\Documents and Settings\M54>d:
D:\>bios_pw 14452 0 1.
unlock6.exe v1.0 1 July 1997
qj119900
0?yqmjd
c.jl14tm
6mbzjaj 2.
D:\>_
```

- 
3. Reboot the system and key in the selected string (qjig9vy, 07yqmjd etc.) for the BIOS user password.



# Machine Disassembly and Replacement

---

This chapter contains step-by-step procedures on how to disassemble the notebook computer for maintenance and troubleshooting.

## Disassembly Requirements

To disassemble the computer, you need the following tools:

- Wrist grounding strap and conductive mat for preventing electrostatic discharge
- Flat screwdriver
- Philips screwdriver
- Hex screwdriver
- Plastic flat screwdriver
- Plastic tweezers

**NOTE:** The screws for the different components vary in size. During the disassembly process, group the screws with the corresponding components to avoid mismatch when putting back the components.

---

# General Information

## Pre-disassembly Instructions

Before proceeding with the disassembly procedure, make sure that you do the following:

1. Turn off the power to the system and all peripherals.
2. Unplug the AC adapter and all power and signal cables from the system.



3. Place the system on a flat, stable surface.
4. Remove the battery pack.

## Disassembly Process

The disassembly process is divided into the following stages:

- External module disassembly
- Main unit disassembly
- LCD module disassembly

The flowcharts provided in the succeeding disassembly sections illustrate the entire disassembly sequence. Observe the order of the sequence to avoid damage to any of the hardware components. For example, if you want to remove the main board, you must first remove the keyboard, then disassemble the inside assembly frame in that order.

### Main Screw List

Screw	Quantity	Part Number
M2.5*8 (NL)	15	MA000005YG0
M2.5*5 (NL)	22	MA000007YG0
M2.5*3 (NL)	2	MA000005WG0
M2*3 (NL)	36	MA0000060G0
M2.5*4 (NL)	2	MA0000005G0
M2*6 (NL)	4	MMCK20060G0
M2*4-NI (NL)	5	MACK20040G0
M3*3 (NL)	4	MAAA03032G0
M2*6.5	4	MA0000096G0
M2.5*5.0	2	MA000002NG0
M2.5*6.5	4	MA000006C00

---

# External Module Disassembly Process

## External Modules Disassembly Flowchart

The flowchart below gives you a graphic representation on the entire disassembly sequence and instructs you on the components that need to be removed during servicing. For example, if you want to remove the main board, you must first remove the keyboard, then disassemble the inside assembly frame in that order.



### Screw List

Step	Screw	Quantity	Color	Part No.
Memory Cover	M2.5*8 (NL)	4	Black	MA000005YG0
HDD Cover	M2*6 (NL)	2	Black	MMCK20060G0
WLAN Cover	M2.5*8 (NL)	4	Black	MA000005YG0
WLAN Module	M2*3 (NL)	2	Black	MA0000060G0
HDD Carrier	M3*3 (NL)	4	Silver	MAAA03032G0
ODD Module	M2.5*5(NL)	1	Black	MA000002NG0
ODD Bracket	M2*3 (NL)	3	Black	MA0000060G0

---

## Removing the Battery Pack

1. Turn computer over.
2. Slide the battery lock/unlock latch to the unlock position.



3. Slide and hold the battery release latch to the release position (1), then slide out the battery pack from the main unit (2).





---

## Removing the SD dummy card

1. Push the SD dummy card all the way in to eject it.



2. Pull it out from the slot.



---

## Removing the ExpressCard dummy card

1. Push the ExpressCard dummy card all the way in to eject it.



2. Pull it out from the slot.



---

## Removing the Lower Covers

1. See "Removing the Battery Pack" on page 46.
2. See "Removing the Lower Covers" on page 49.
3. See "Removing the Lower Covers" on page 49.
4. Loosen the ten captive screws from the Memory, HDD1, and HDD2 Covers.

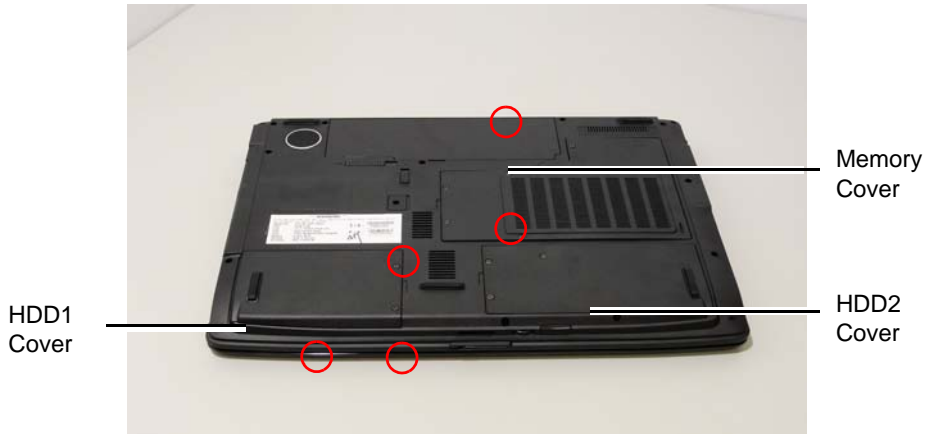

5. Carefully open the memory cover.



6. Remove the HDD1 cover as shown.



7. Remove the HDD2 cover as shown.



## Removing the DIMM Modules

1. See “Removing the Battery Pack” on page 46.
2. Remove the Memory Module cover. See “Removing the Lower Covers” on page 49.
3. Push out the release latches on both sides of the DIMM socket to release the DIMM module.

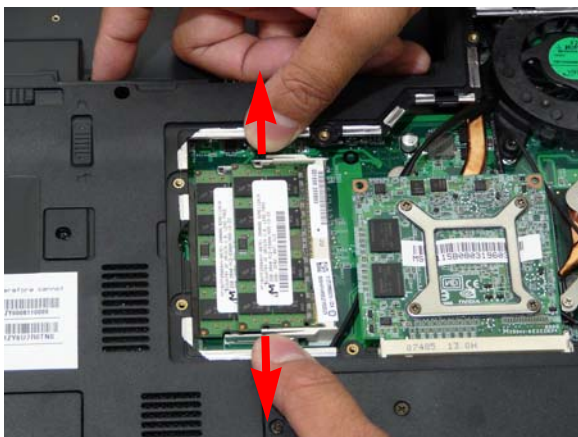

4. Remove the DIMM module.



5. Repeat steps for the second DIMM module.

## Removing the MXM Module

1. See "Removing the Battery Pack" on page 46.
2. Remove the Memory Module cover. See "Removing the Lower Covers" on page 49.
3. Remove the four securing screws.

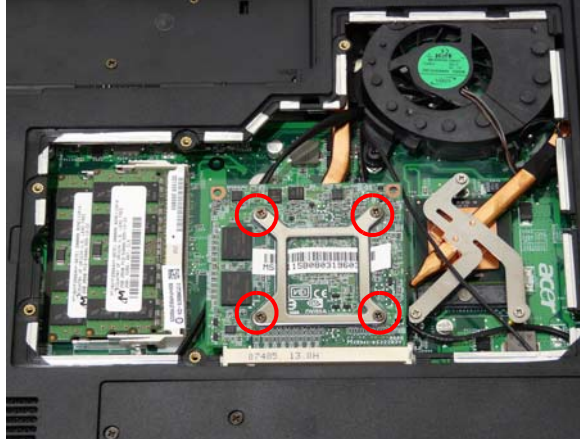

Step	Size	Quantity	Screw Type
WLAN Module	M2.5*9 (NL)	4	

4. Grasp the module and remove.

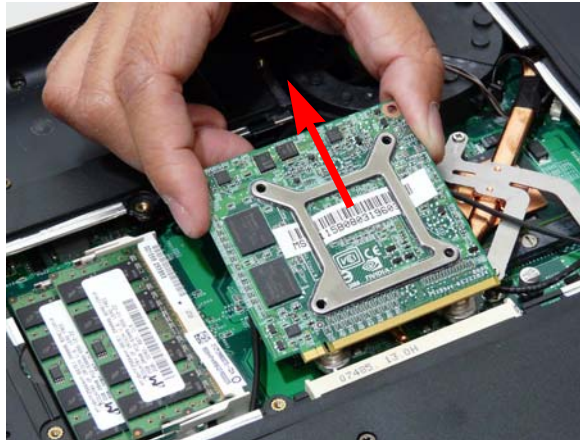

## Removing the Turbo RAM module

1. See "Removing the Battery Pack" on page 46.
2. Remove the HDD2 cover. See "Removing the Lower Covers" on page 49.

3. Remove the three securing screws.

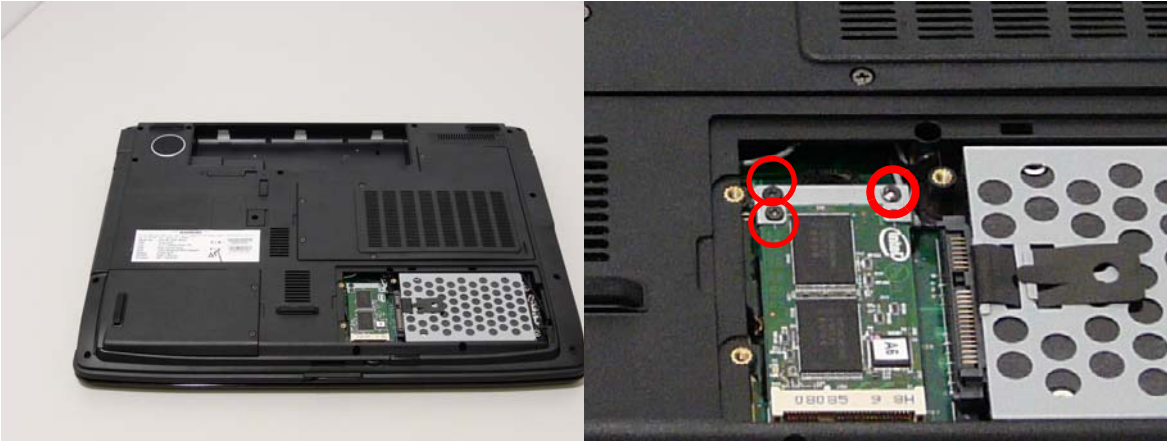

Step	Size	Quantity	Screw Type
WLAN Module	M2*3 (NL)	3	

4. Remove the bracket from the module.



5. Remove the Turbo RAM Module.



**NOTE:** Some models come equipped with either a TV Tuner module or a Turbo RAM module.

## Removing the TV Tuner module

1. See "Removing the Battery Pack" on page 46.
2. Remove the HDD2 cover. See "Removing the Lower Covers" on page 49.
3. Disconnect the TV Tuner cable from the module.



4. Remove the three securing screws.

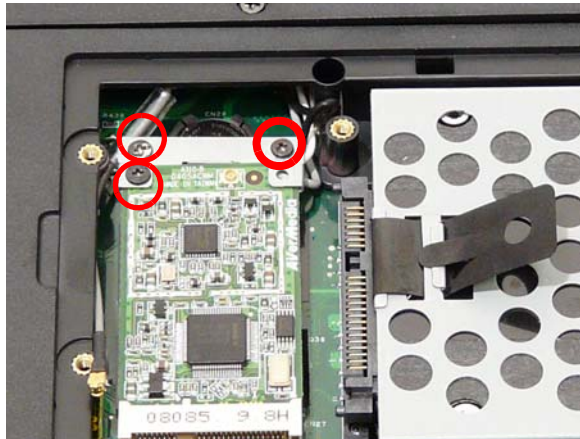

Step	Size	Quantity	Screw Type
TV Tuner Module	M2*3 (NL)	3	

5. Remove the bracket from the module.



6. Remove the TV Tuner module.

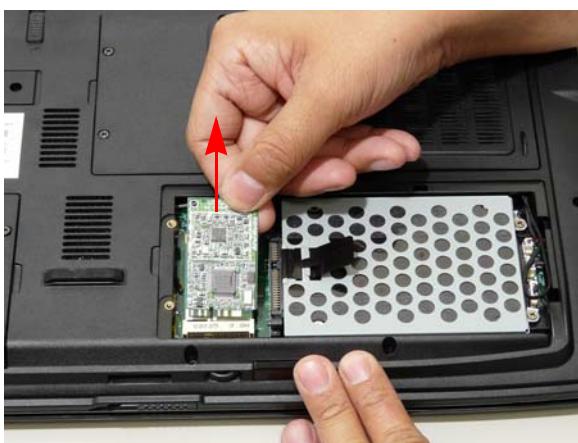

**NOTE:** Some models come equipped with either a TV Tuner module or a Turbo RAM module.

## Removing the WLAN Module

1. See "Removing the Battery Pack" on page 46.
2. Remove the HDD2 cover. See "Removing the Lower Covers" on page 49.
3. Remove the Turbo RAM. See "Removing the TV Tuner module" on page 53.
4. Disconnect the antenna cables from the WLAN board.





**NOTE:** The following is the correct cable-color to connector designation: TR1 (left) to White, TR3 (middle) to Gray, and TR2 (right) to Black.

5. Move the cables away to avoid damaging the them, and remove the two screws on the WLAN board to release the WLAN board.



Step	Size	Quantity	Screw Type
WLAN Module	M2*3 (NL)	2	

6. Detach the WLAN board from the WLAN socket.



## Removing the Hard Disk Drive1 Module

1. Remove the Battery Pack. See “Removing the Battery Pack” on page 46.
2. Remove the HDD1 cover. See “Removing the Lower Covers” on page 49.

3. Remove the two securing screws.



Step	Size	Quantity	Screw Type
HDD Carrier	M2*3 (NL)	2	

4. Use the pull-tab to lift up the HDD1 module to remove.



**NOTE:** To prevent damage to device, avoid pressing down on it or placing heavy objects on top of it.

5. Remove the four screws (two each side) securing the HDD to the carrier.

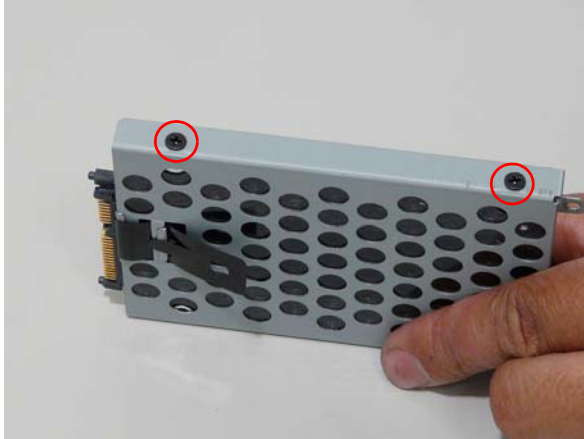

Step	Size	Quantity	Screw Type
HDD Carrier	M2*3 (NL)	4	

6. Turn the HDD module upside down, and lift the HDD carrier up.



## Removing the Hard Disk Drive2 Module

1. See "Removing the Battery Pack" on page 46.
2. Remove the HDD2 cover. See "Removing the Lower Covers" on page 49.
3. Remove the two securing screws.

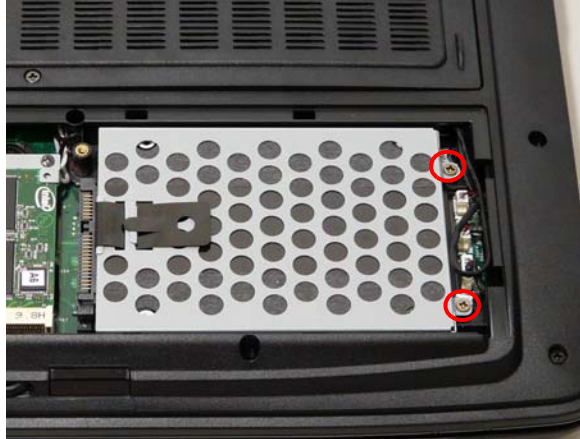

Step	Size	Quantity	Screw Type
HDD Carrier	M2*3 (NL)	2	

4. Use the pull-tab to lift up the HDD module and remove.



**NOTE:** To prevent damage to device, avoid pressing down on it or placing heavy objects on top of it.

5. Remove the four screws (two each side) securing the HDD to the carrier.

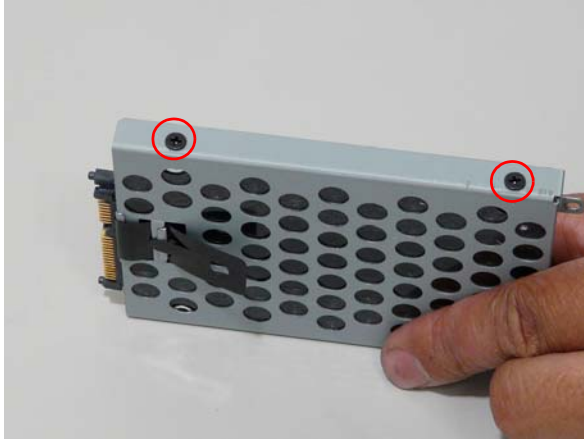

Step	Size	Quantity	Screw Type
HDD Carrier	M2*3 (NL)	4	

6. Turn the HDD module upside down, and lift the HDD carrier up.



7. Remove the connector from the HDD.

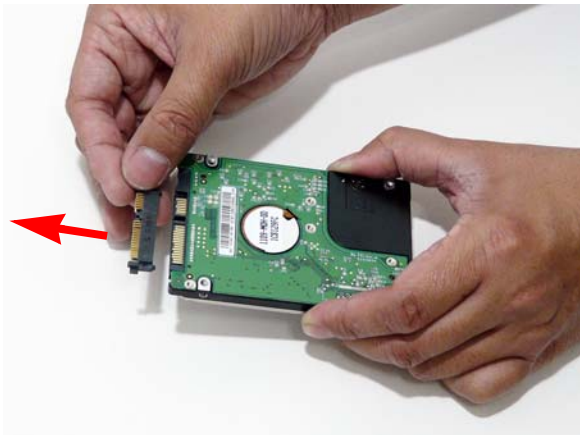

---

## Removing the Optical Drive Module

1. See "Removing the Battery Pack" on page 46.
2. Remove the Memory cover. See "Removing the Lower Covers" on page 49.
3. Loosen the captive screw securing the ODD module and remove the ODD cap.



4. Carefully use a screwdriver to push the locking catch and remove the ODD module.



5. Grasp the module and pull out from the main unit.



6. Remove the two screws securing the ODD bracket and remove the ODD bracket from the optical disk drive module.

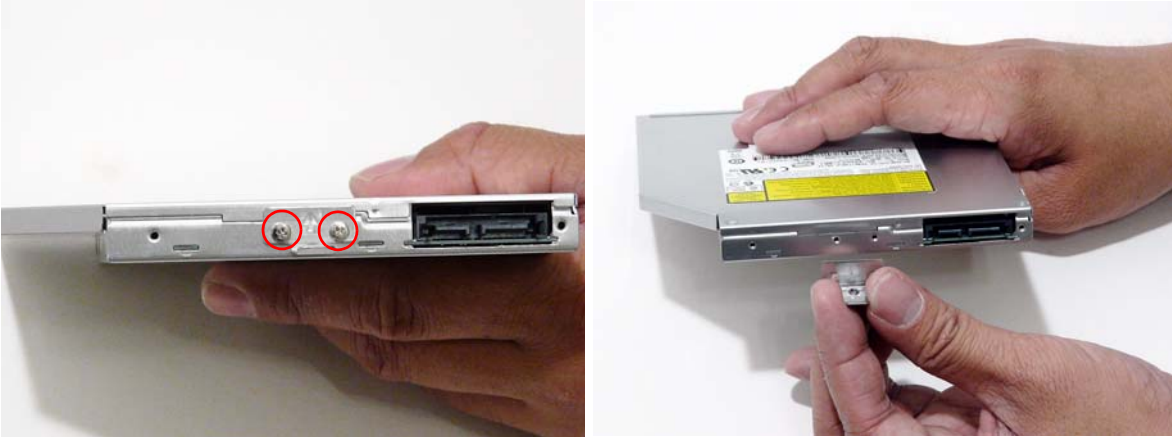

Step	Size	Quantity	Screw Type
ODD Bracket	M2*2.5(NL)	2	

7. Insert a pin in the eject hole of the ODD to eject the ODD tray.



8. Press down on the locking catch to release the ODD cover and remove.

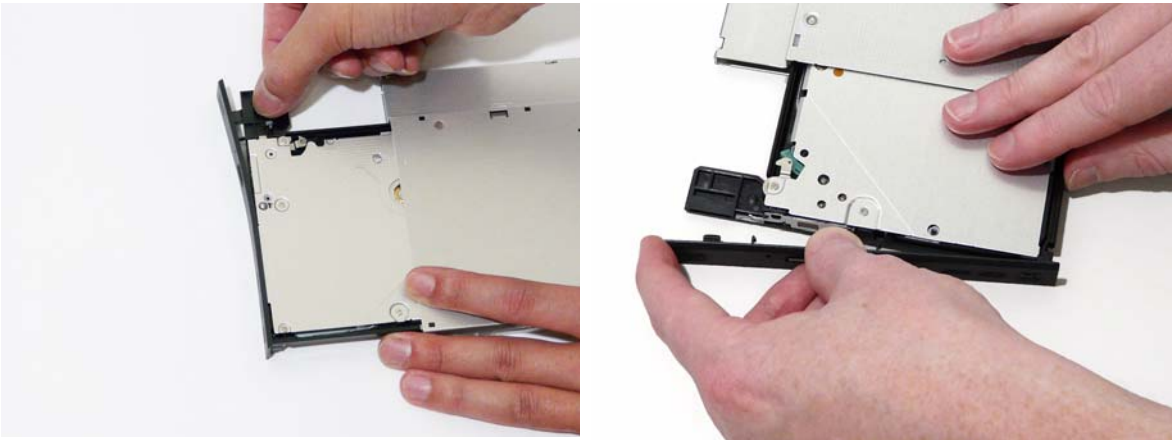

---

# Main Unit Disassembly Process

## Main Unit Disassembly Flowchart



### Screw List

Step	Screw	Quantity	Color	Part No.
Switch Cover	M2*3 (NL)	2		MA0000060G0
LCD Module	M2.5*8(NL)	4		MA000005YG0
LCD Module	M2.5*5 (NL)	2		MA000007YG0
Upper Cover	M2.5*8 (NL)	8		MA000005YG0
Upper Cover	M2.5*5 (NL)	7		MA000007YG0
Touch Pad Bracket	M2*3 (NL)	2		MA0000060G0
Launch Board	M2*3 (NL)	2		MA0000060G0
Speaker	M2*3 (NL)	4		MA0000060G0
I/O Board	M2.5*5 (NL)	1		MA000007YG0
Bluetooth Board	M2*3 (NL)	1		MA0000060G0
Modem Module	M2*3 (NL)	2		MA0000060G0
Mainboard	M2.5*5 (NL)	1		MA000007YG0
Thermal Module	M2*6.5	4		MA0000096G0
CPU Fan	M2*4-NI (NL)	3		MACK20040G0
HDMI Module	M2*4-NI (NL)	2		MACK20040G0



## Removing the Switch Cover

**CAUTION:** Using tools to remove the Switch Cover may cause damage to the outer casing. It is recommended that only fingers are used to remove the Switch Cover.

1. Remove the Battery Pack. See “Removing the Battery Pack” on page 46.
2. Locate and remove the nine securing screws as shown.

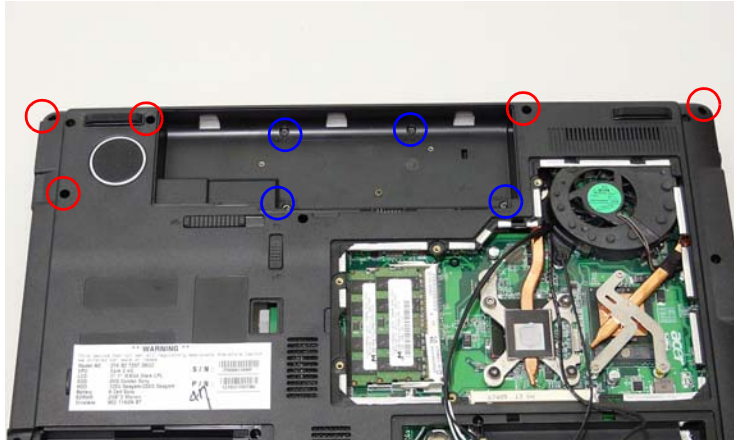

Step	Size	Quantity	Screw Type
Switch Cover	M2.5*3(NL) Blue Callout	4	
Switch Cover	M2.5*6.5(NL) Red Callout	5	

3. Turn the computer over and open the LCD module fully to expose the Switch Cover.
4. Lift the Switch Cover up and away.



## Removing the Switch Board

1. Remove the Switch Cover. See "Removing the Switch Cover" on page 63.
2. Remove the two securing screws from the Switch Board.

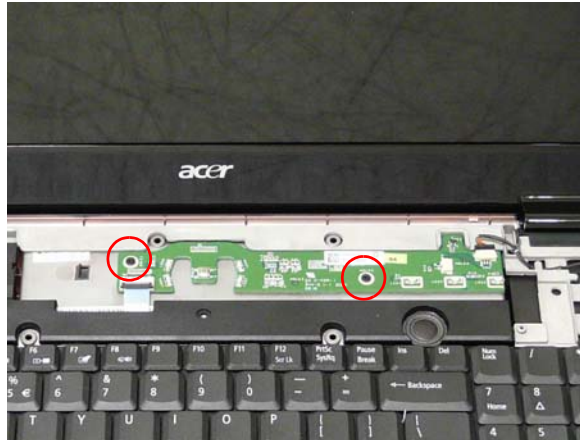

Step	Size	Quantity	Screw Type
Switch Board	M2*3 (NL)	2	

3. Disconnect the Switch Board to Ekey board FFC cable as shown.



4. Use the tweezers to secure the cable in place, then remove the Switch Board away from the top cover.



---

## Removing the Keyboard

1. Remove the Switch Cover. See “Removing the Switch Cover” on page 63.
2. Grasp the keyboard and lift up to remove.



3. Lift the keyboard over and disconnect the keyboard FFC.

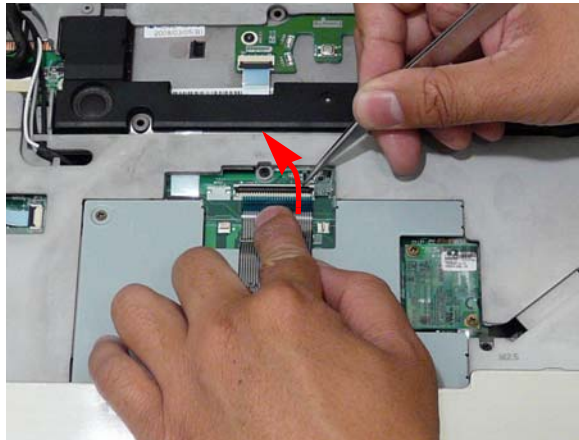

4. Remove the keyboard and place it on a clean surface.

## Removing the Modem Module

1. Remove the Keyboard. See “Removing the Keyboard” on page 65.

2. Remove the two securing screws.



Step	Size	Quantity	Screw Type
Modem Module	M2*3 (NL)	2	

3. Using a plastic pry, partially lift up the module to expose the connector.

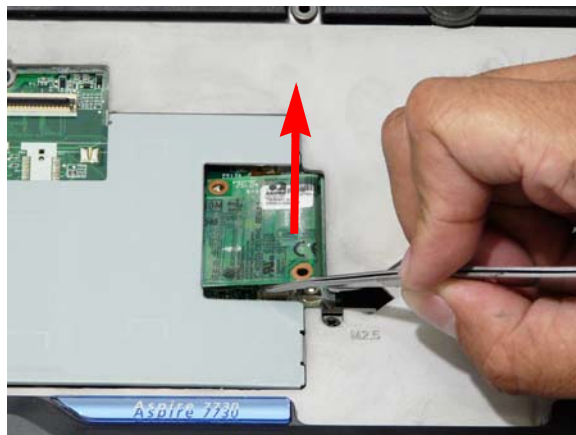

4. While holding the module, use the plastic tweezers to hold the connector and pull the module away to remove.

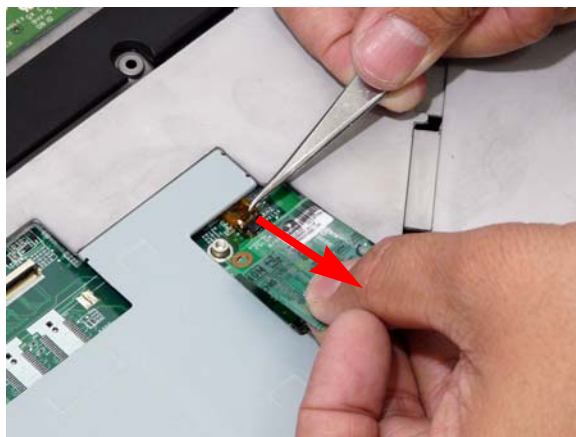

---

## Removing the Antenna, MIC and Speaker Cables

**IMPORTANT:** Ensure the Antenna Cables are free of any obstructions before attempting to remove.

1. Remove the WLAN Module. See “Removing the WLAN Module” on page 54.
2. Remove the HDD2 Module. See “Removing the Hard Disk Drive2 Module” on page 58.
3. Remove the MXM Module. See “Removing the MXM Module” on page 51.
4. Remove the Keyboard. See “Removing the Keyboard” on page 65.
5. Gently pull the Antenna Cables through the HDD housing.



6. Disconnect the MIC and speaker cables.

**IMPORTANT:** Use tweezers to remove the cable connectors. Do not pull on the cable itself to prevent stripping.



7. Gently pull the MIC and Speaker cables through the HDD housing.



8. Turn the computer on its side, and feed cables through to the upperside.



9. Pull the cables completely through.

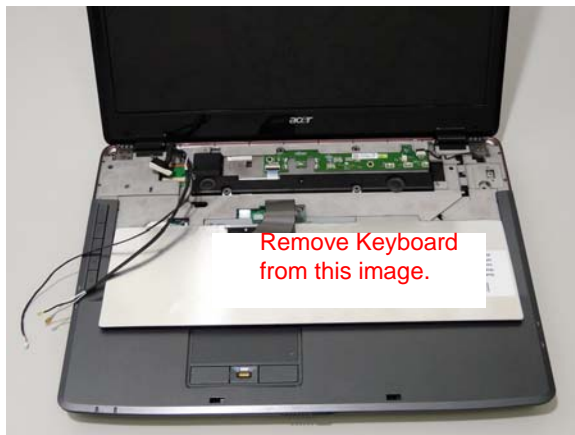

## Removing the LCD Module

1. Remove the Battery Pack. See “Removing the Battery Pack” on page 46.
2. Remove the SD dummy card. See “Removing the Lower Covers” on page 49.
3. Remove the Express dummy card. See “Removing the Lower Covers” on page 49.
4. Remove the Lower Covers. See “Removing the Lower Covers” on page 49.
5. Remove the DIMM Modules. See “Removing the DIMM Modules” on page 50.
6. Remove the WLAN Module. See “Removing the WLAN Module” on page 54.
7. Remove the HDDs. See “Removing the Hard Disk Drive1 Module” on page 55. See “Removing the Hard Disk Drive2 Module” on page 58.
8. Remove the ODD. See “Removing the Optical Drive Module” on page 60.
9. Remove the Modem Module. See “Removing the Modem Module” on page 65.
10. Disconnect the Antenna, MIC and Speaker cables. See “Removing the Antenna, MIC and Speaker Cables” on page 67.
11. Remove the two securing screws from the bottom of the chassis.



Step	Size	Quantity	Screw Type
LCD Module	M2.5*6.5(NL)	2	

12. Turn the computer over. Use the tweezers to disconnect the LCD interface cable from the chassis.

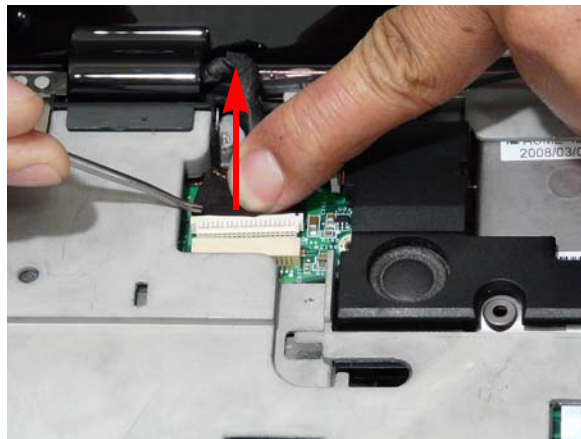

13. Remove the single ground screw and four securing screws (two each side) connecting the LCD module.

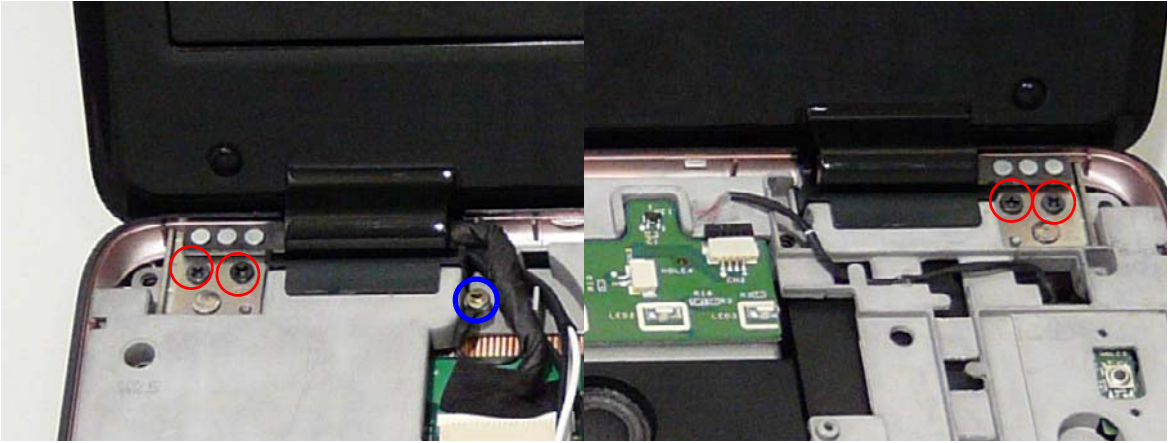

Step	Size	Quantity	Screw Type
LCD Module	M2.5*6.5 (NL) Red Callout	4	
Ground	M2.5*3 (NL) Blue Callout	1	

14. Carefully remove the LCD module from the chassis.

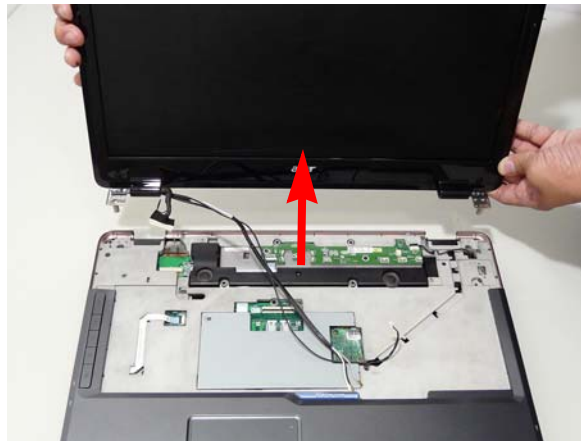



# Removing the Upper Cover

- 1. See "Removing the LCD Module" on page 69.
- 2. Place the computer upside down and remove the remaining eleven screws on the bottom panel.

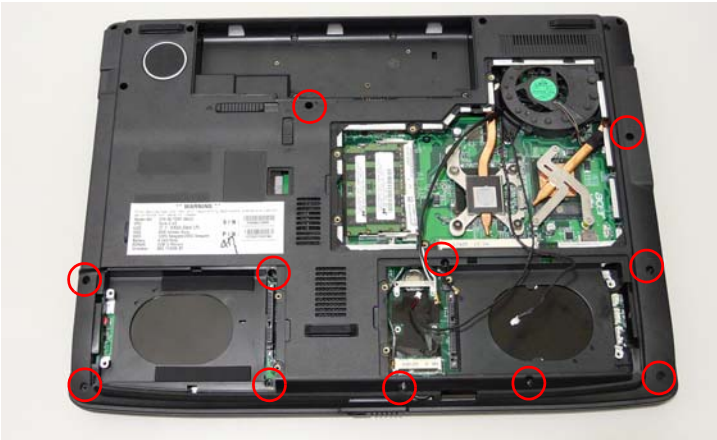

Step	Size	Quantity	Screw Type
LCD Module	M2.5*6.5(NL)	11	

- 3. Turn the computer over and loosen the captive screw from the keyboard plate.

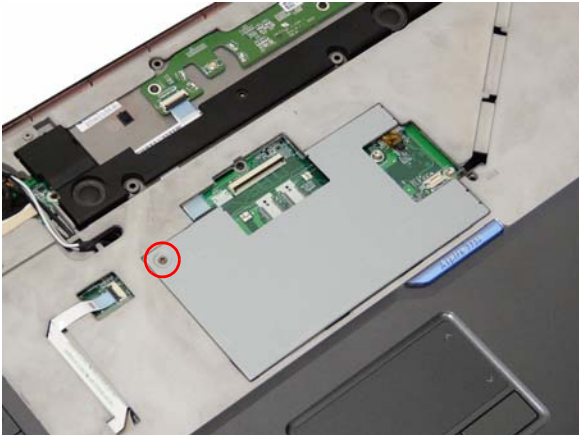

- 4. Remove the keyboard plate. If necessary, use a plastic pry to lift the plate.



5. Disconnect the five cables from the mainboard as shown.

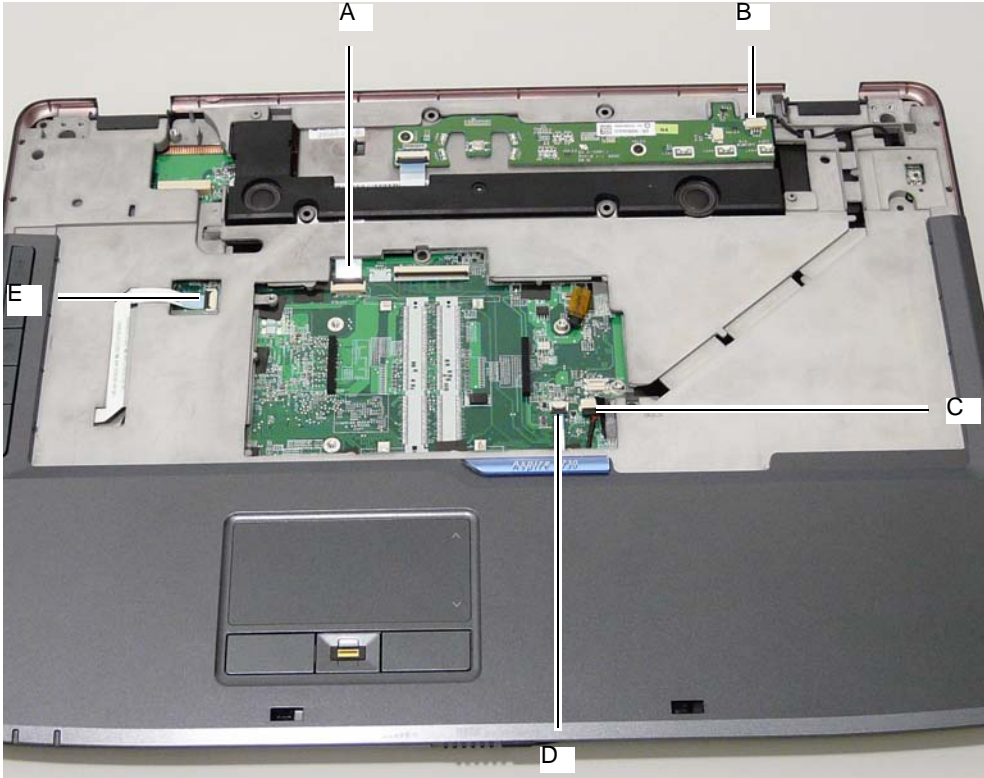

**IMPORTANT:**When removing cables, always hold the cable by the pull-tab or by the connector. Do not hold the pull by the cable itself to prevent stripping.

Disconnect A as shown.

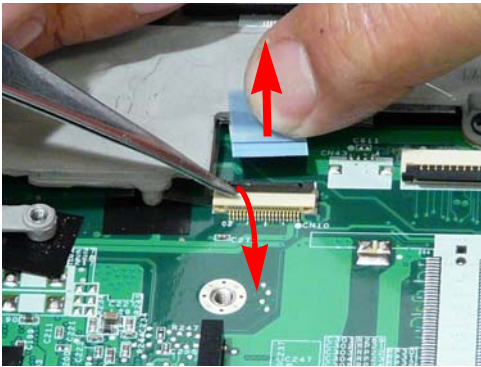

Release the securing latches and disconnect B as shown.

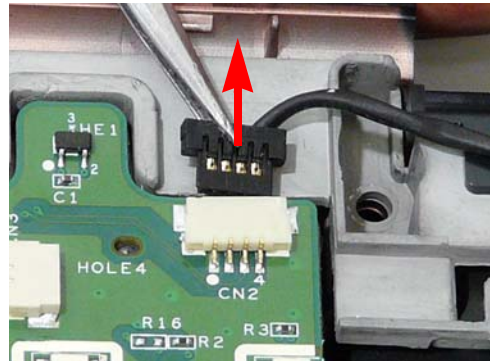

Release the securing latches and disconnect C as shown.

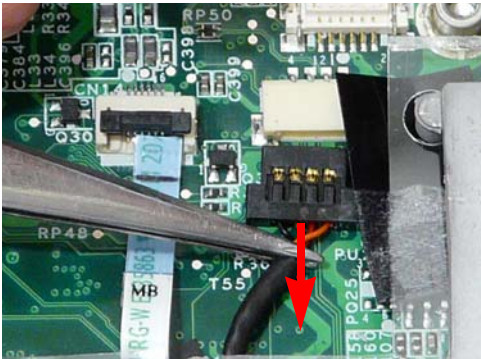

Release the securing latches and disconnect D as shown.

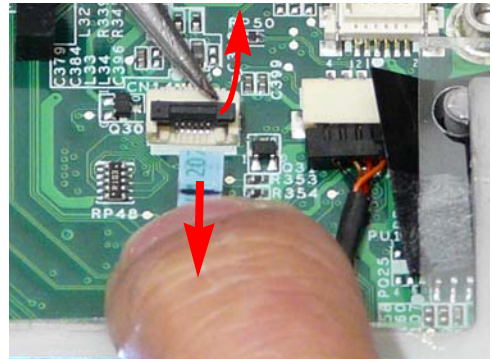

---

Release the securing latches and disconnect E as shown.

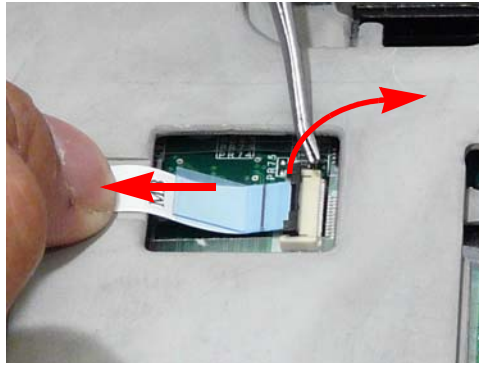

6. Remove the four securing screws from the upper cover.

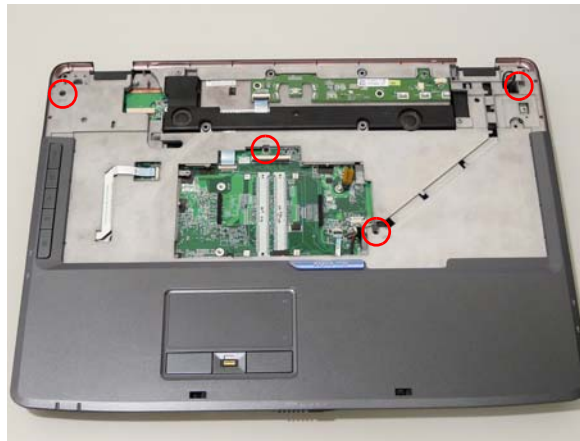

7. Grasp the Upper Cover by the hinge socket and pry it open. Do not lift the cover completely off.  
**NOTE:** Do not try to pry open more than one edge at a time.

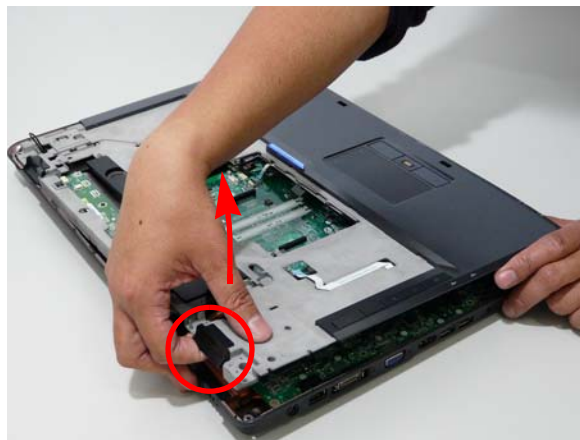

8. While holding the cover open, pull through any remaining cables.



9. Grasp the cover by the opposite edge and lift up to remove the Upper Cover.

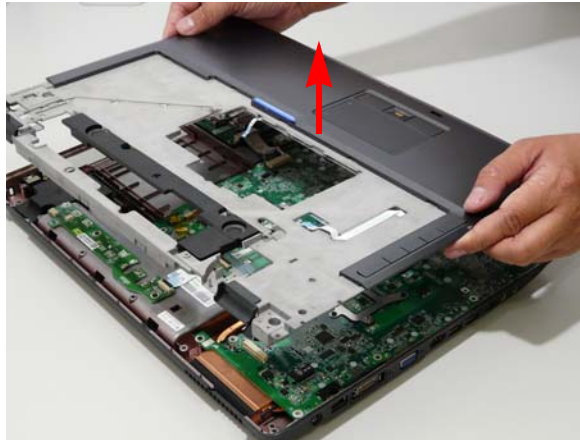

---

## Removing the Touch Pad

1. Remove the Upper Cover. See “Removing the Upper Cover” on page 71.
2. Remove the Speaker Module. See “Removing the Speaker Module” on page 79.
3. Remove the Finger Print Reader Module. See “Removing the Finger Print Reader” on page 76.
4. Remove the Launch Board Module. See “Removing the Launch Board” on page 77.
5. Remove the Launch Board Module. See “Removing the Launch Board” on page 77.
6. Disconnect the Touch Pad cable from the Touch Pad board.

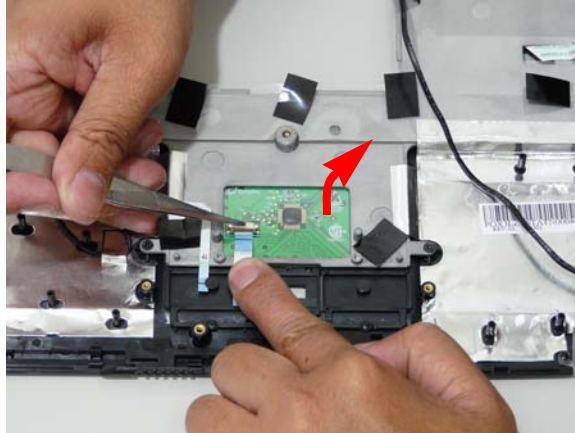

**IMPORTANT:**The Touch Pad cannot be removed individually. To replace the Touch Pad, replace the entire Upper Cover.

# Removing the Finger Print Reader

1. Remove the Upper Cover. See "Removing the Upper Cover" on page 71.
2. Disconnect the cable as shown.

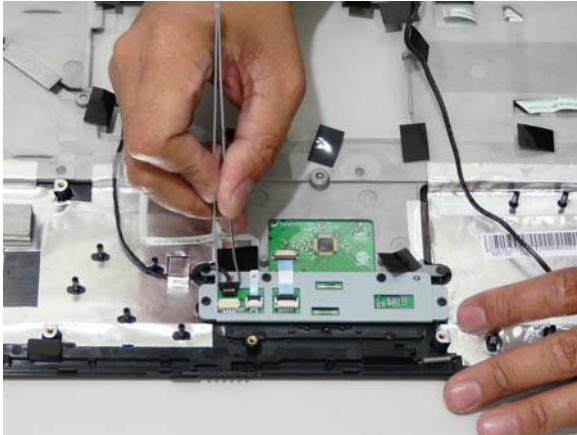

3. Disconnect the two FFC cables as shown.

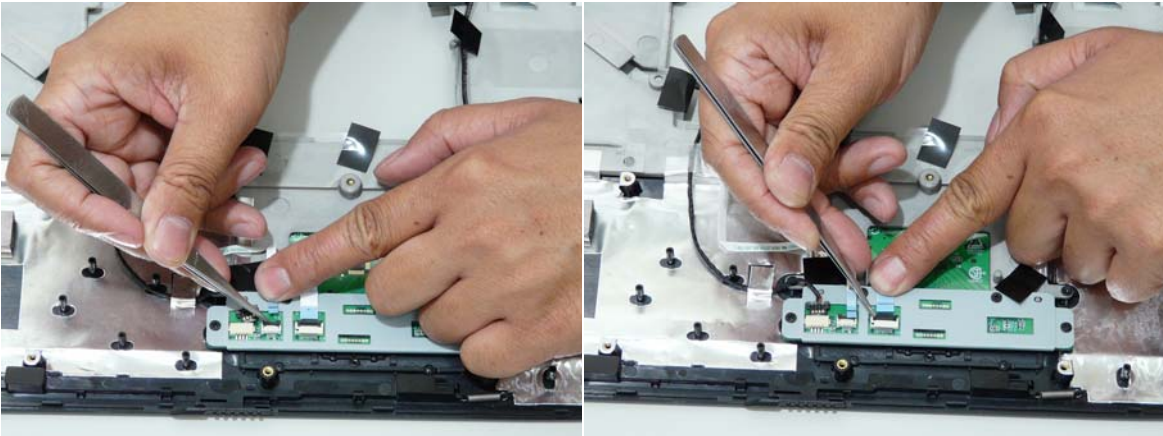

4. Remove the four securing screw from the Finger Print Reader board.

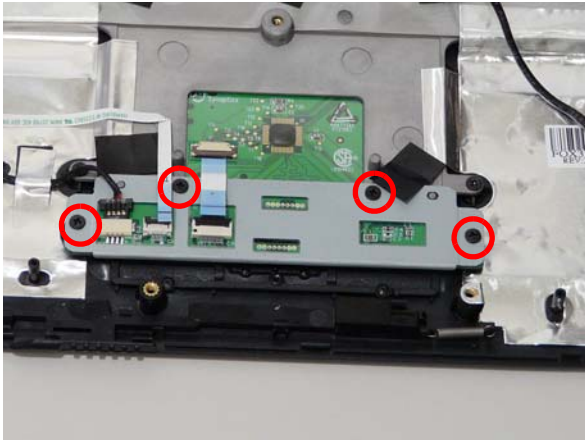

Step	Size	Quantity	Screw Type
Launch Board	M2*3 (NL)	4	

5. Remove the bracket from the board.

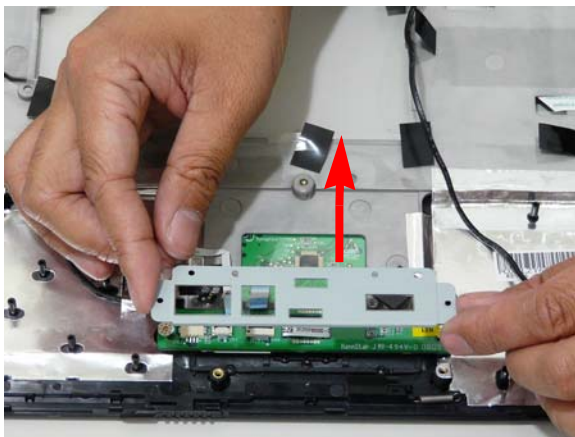

6. Remove the Finger Print Reader board from the Upper Cover.

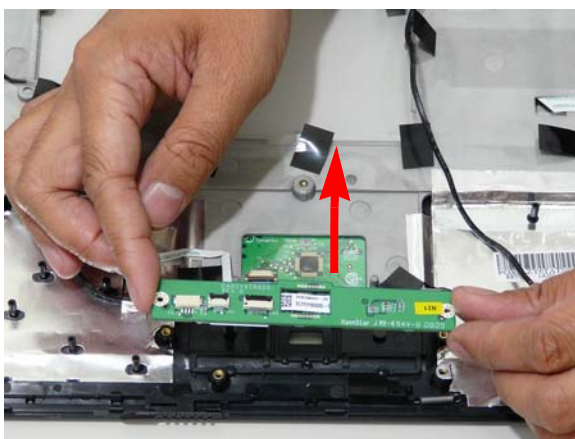

## Removing the Launch Board

1. Remove the Upper Cover. See "Removing the Upper Cover" on page 71.
2. Lift up the locking latch and remove the FFC cable as shown.

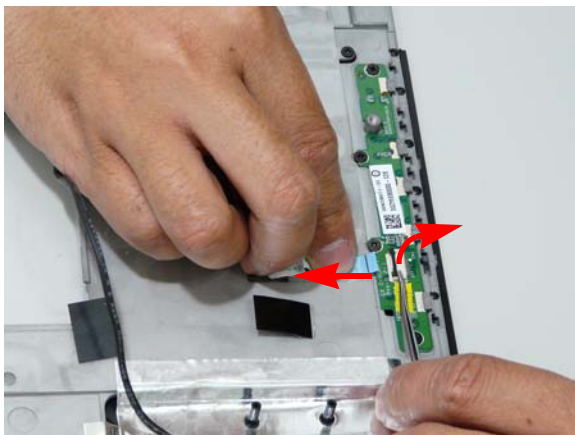

3. Remove the four screws from the Launch Board.

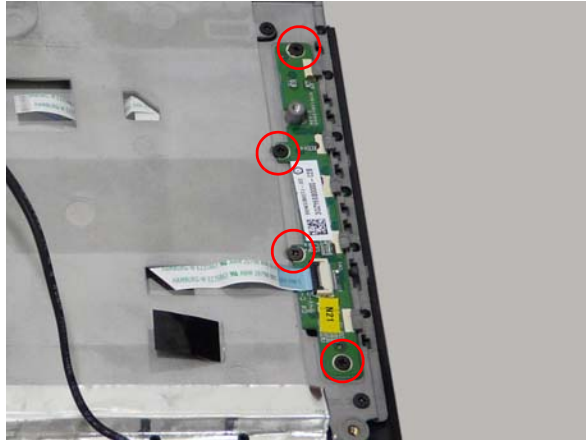

Step	Size	Quantity	Screw Type
Launch Board	M2*3 (NL)	4	

4. Remove the Launch Board from the Upper Cover.

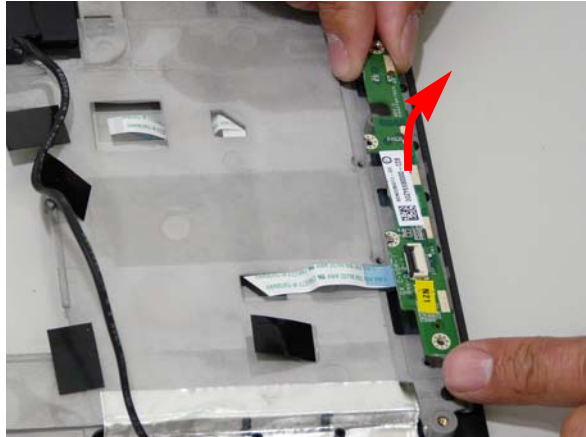



---

## Removing the Speaker Module

1. Remove the Upper Cover. See "Removing the Upper Cover" on page 71.
2. Remove four securing screws connecting the Speaker Module.

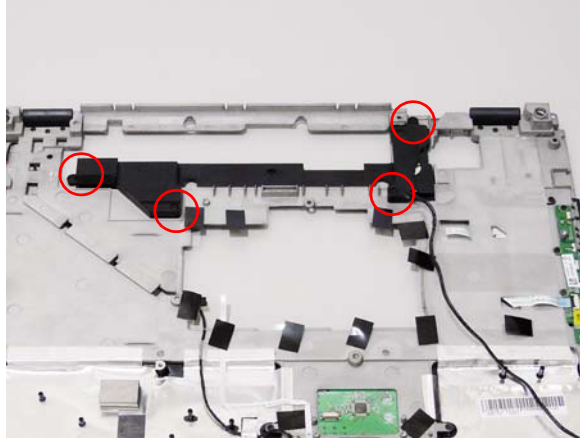

Step	Size	Quantity	Screw Type
Speaker Module	M2*6 (NL)	4	

3. Remove the Speaker Module from the upper cover.

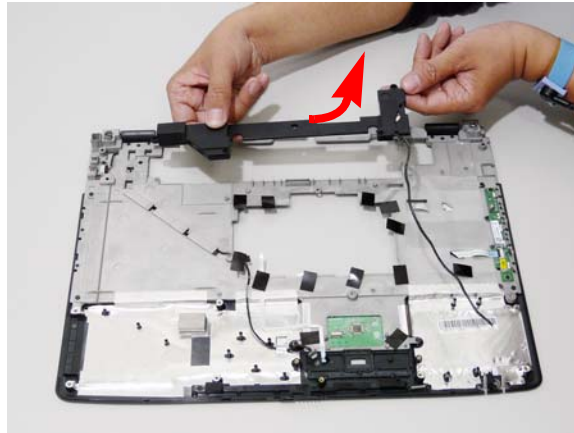

## Removing the eKey Module

1. Remove the Upper Cover. See "Removing the Upper Cover" on page 71.
2. Turn the Upper Cover upside down and remove the two securing screws connecting the eKey module.
3. Disconnect the eKey Module cable.

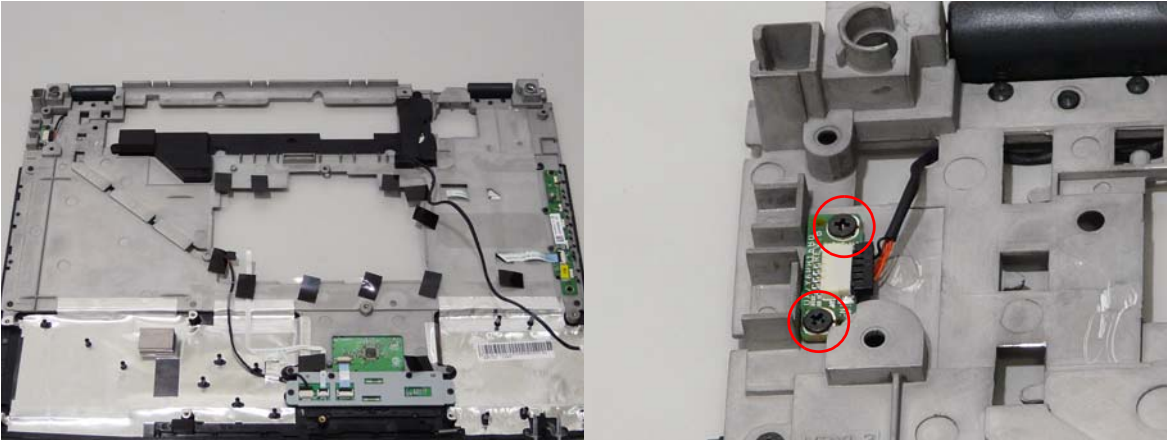

Step	Size	Quantity	Screw Type
Speaker	M2*3 (NL)	2	

4. Remove the module as shown.

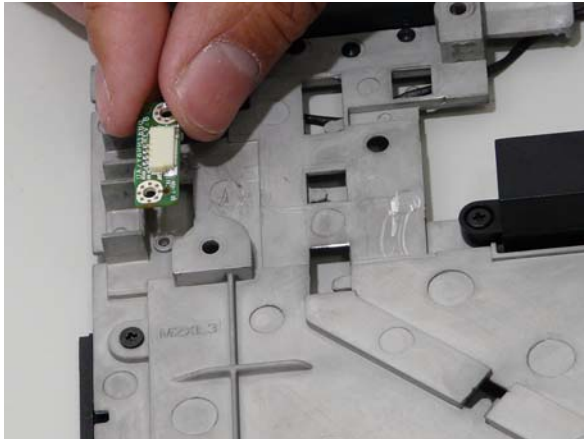

## Removing the Bluetooth board

1. Remove the Upper Cover. See "Removing the Upper Cover" on page 71.
2. Remove the securing screw from the Bluetooth board.

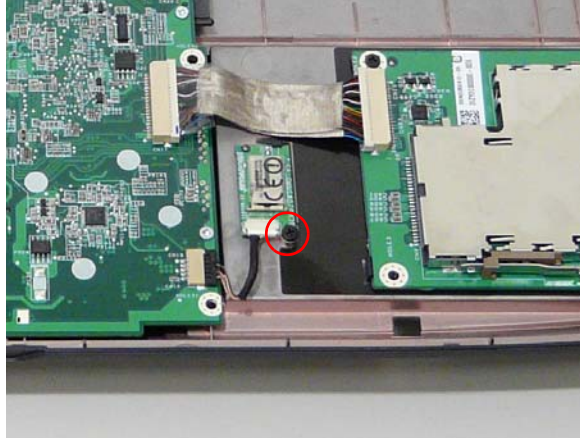

Step	Size	Quantity	Screw Type
Bluetooth Board	M2*3 (NL)	1	

3. Lift the Bluetooth board away from the main board and disconnect the mainboard cable.

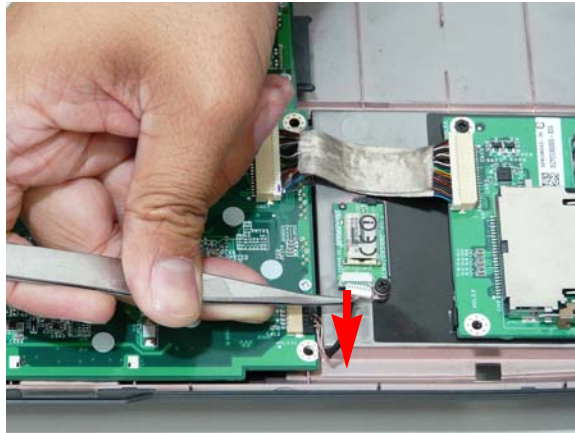

4. Disconnect the cable from the mainboard.

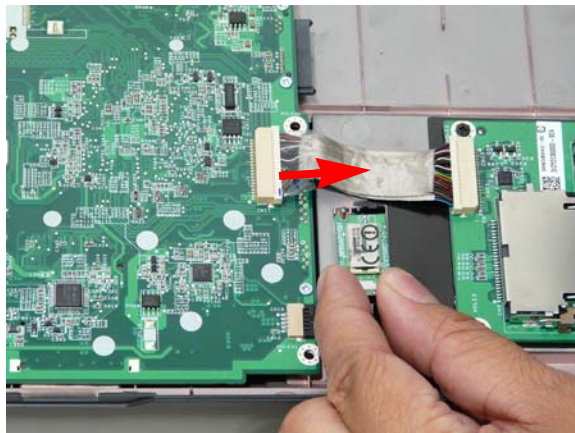

# Removing the Subwoofer Module

1. See "Removing the Upper Cover" on page 71.
2. Remove the four securing screws from the Subwoofer Module.

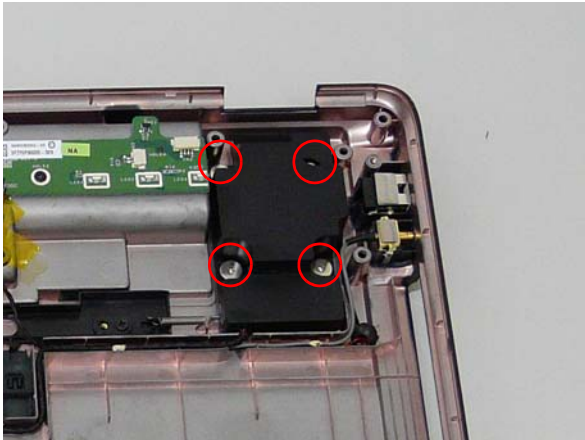

Step	Size	Quantity	Screw Type
Subwoofer Module	M2.5*4 (NL)	4	

3. Grasp the cable by the end and guide it out of its housing as shown in the following images.

**IMPORTANT:**The housing guides are hooked to hold the cable in place. Do not pull the cable to remove it or damage can occur.

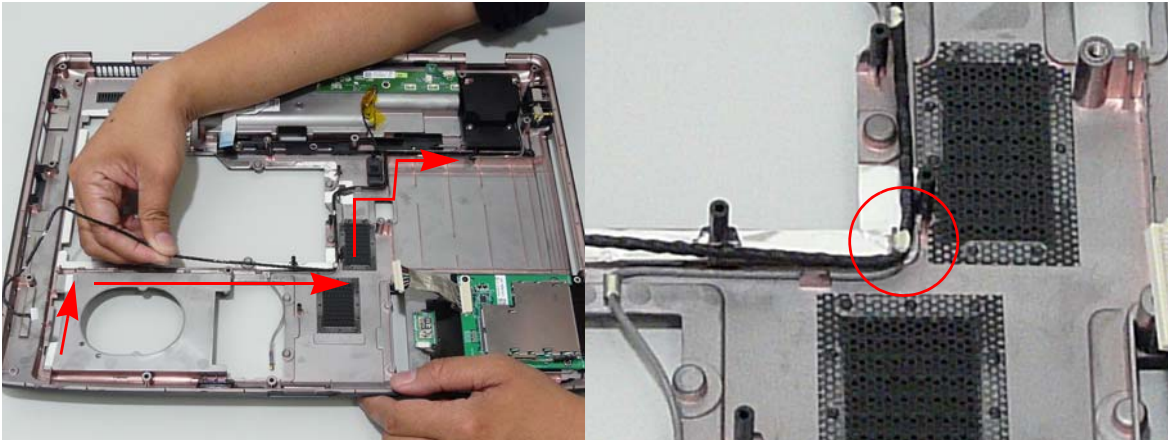

4. Grasp the Subwoofer Module and lift it up to remove.

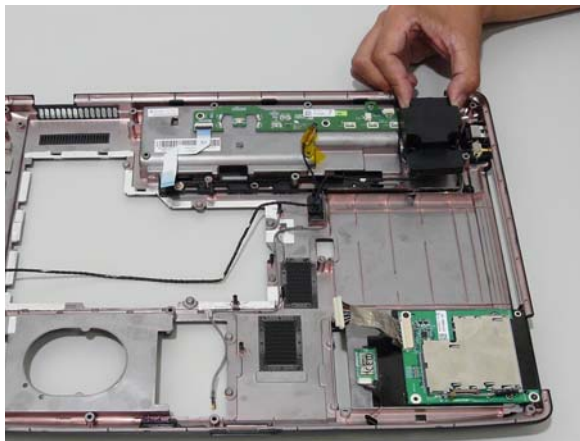

## Removing the ExpressCard Module

1. See "Removing the Upper Cover" on page 71.
2. Remove the two securing screws.

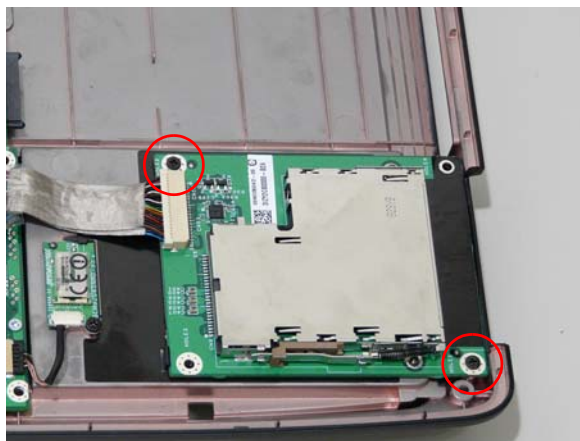

**IMPORTANT:** Do not grasp the cable itself to prevent fraying.

Step	Size	Quantity	Screw Type
Modem Module	M2*3 (NL)	2	

3. Disconnect the cable connecting the ExpressCard module.



4. Lift the ExpressCard module away from the upper cover.

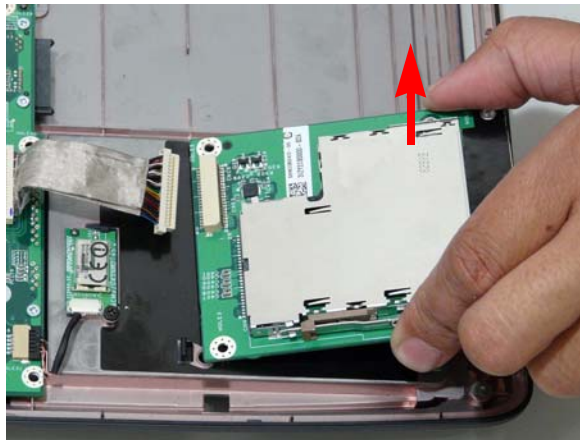

# Removing the Mainboard

1. Remove the Upper Cover. See "Removing the Upper Cover" on page 71.
2. Use the tweezers to lift and remove the tape strip securing the modem cable.

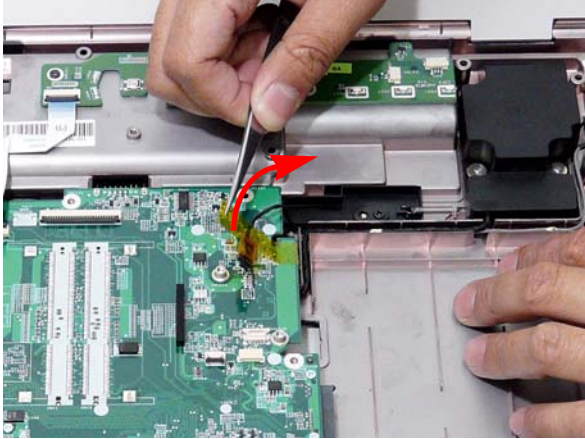

3. Disconnect the two cables connected to the motherboard.

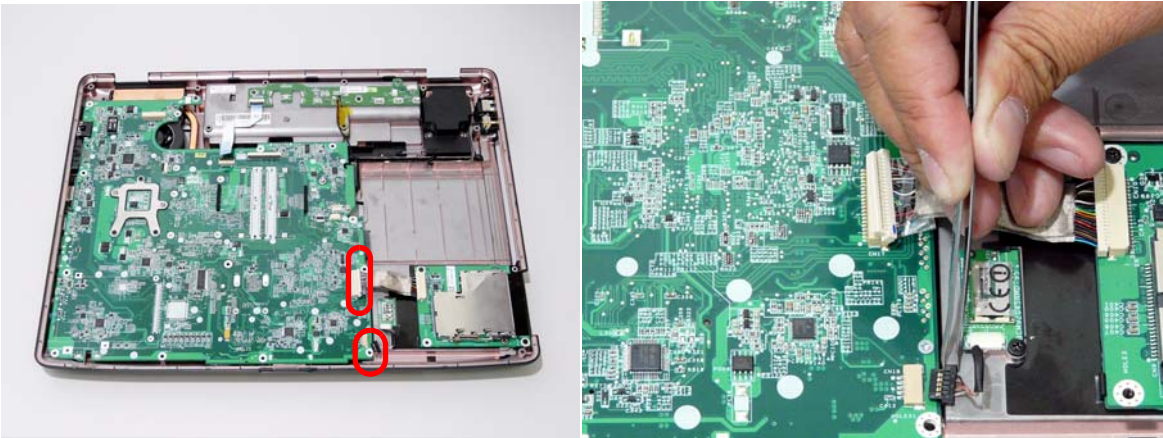

4. Remove the securing screw from the Mainboard.

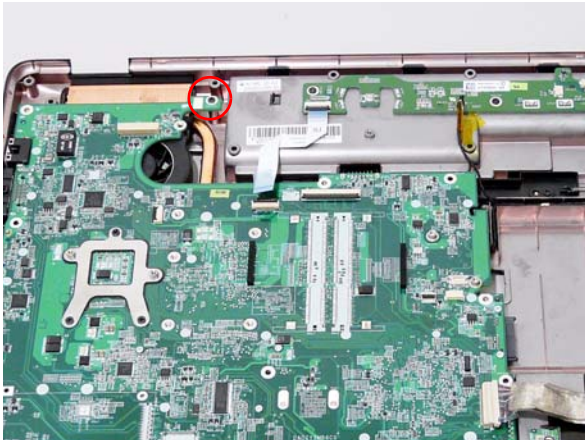

Step	Size	Quantity	Screw Type
Mainboard	M2.5*6.5 (NL)	1	

5. Pull the edge of the lower base outward and lift the motherboard up to remove.

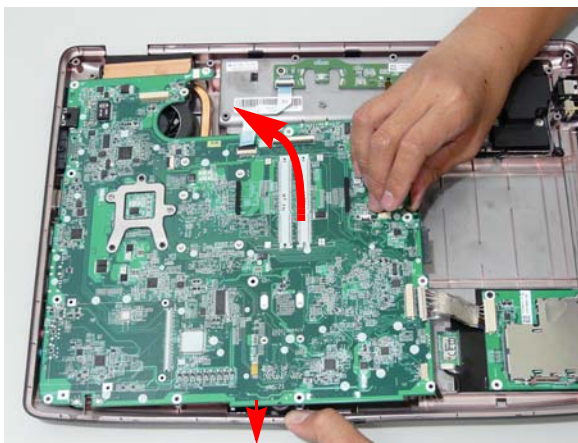

## Removing the CPU Fan Module

1. See "Removing the Battery Pack" on page 46.
2. Remove the Mainboard. See "Removing the Mainboard" on page 85.
3. Turn the Mainboard right side up, and place it on a clean surface.
4. Using tweezers, grip the cable connector and disconnect the Fan cable from the Mainboard.

**IMPORTANT:** Do not grip the cable itself to prevent stripping.

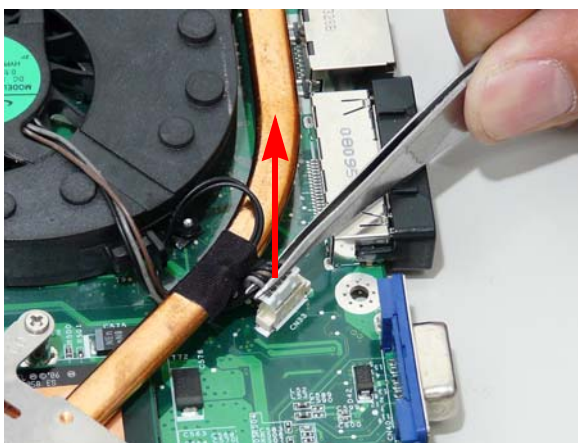

5. Loosen the three captive screws from the heatsink.

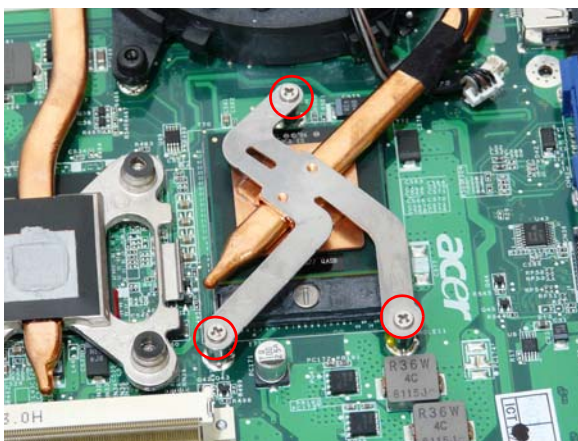



6. Lift the cover to expose the single securing screw. Remove the screw.

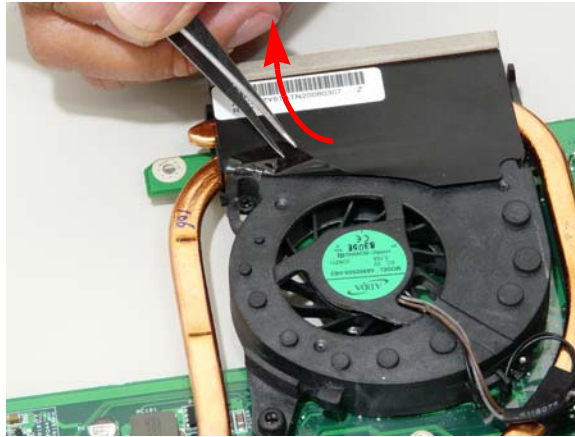

Step	Size	Quantity	Screw Type
Mainboard	M2.5*6.5 (NL)	1	

7. Lift the Fan module clear of the Mainboard.

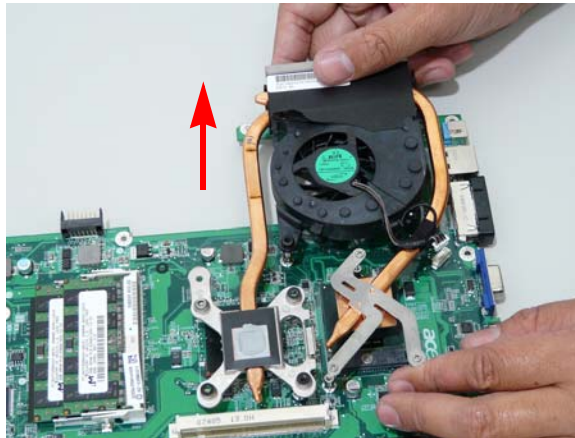

## Removing the CPU

1. Remove the CPU Fan Module. See "Removing the CPU Fan Module" on page 86.

2. Using a flat screwdriver, turn the CPU socket latch clockwise 180° to release the CPU.

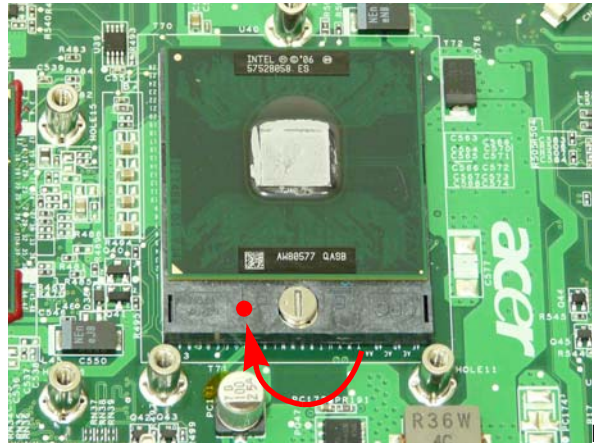

3. Lift the CPU clear of the Mainboard.

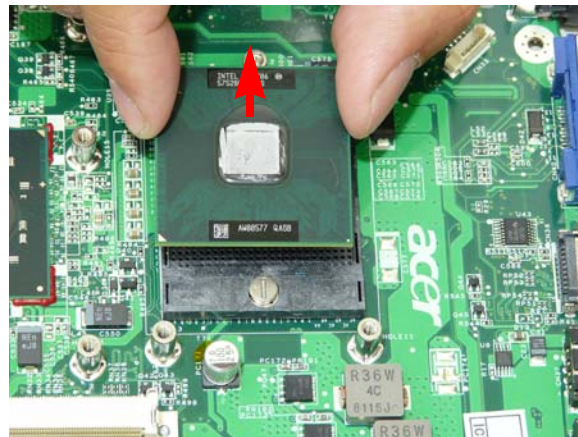

---

# LCD Module Disassembly Process

## LCD Module Disassembly Flowchart

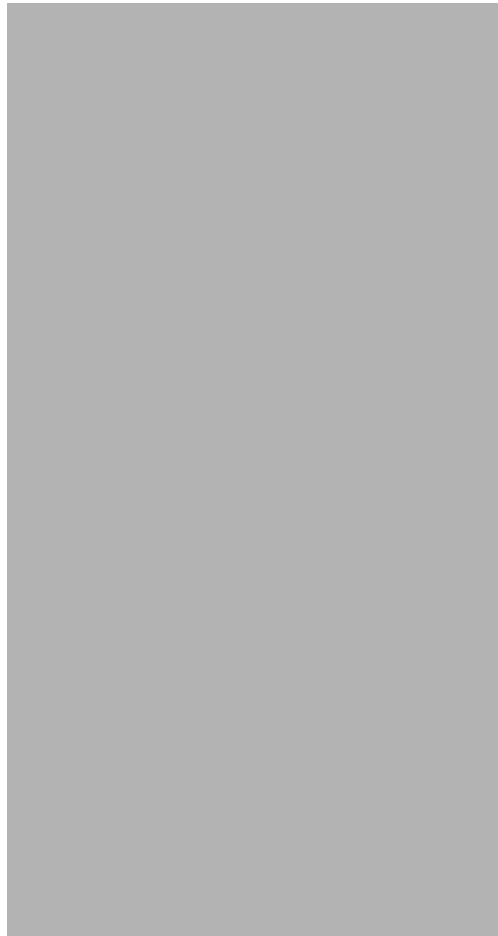

### Screw List

Step	Screw	Quantity	Color	Part No.
LCD Bezel	M2.5*5 (NL)	4	Black	MA000007YG0
Inverter Board	M2.5*5 (NL)	1	Black	MA000007YG0
Camera Module	M2*3 (NL)	2	Black	MA0000060G0
LCD Panel	M2.5*5 (NL)	2	Black	MA000007YG0
LCD Brackets	M2*3 (NL)	8	Black	MA0000060G0

# Removing the LCD Bezel

- 1. Remove the LCD Module. See "Removing the LCD Module" on page 69.
- 2. Remove the six rubber covers and screws.



Step	Size	Quantity	Screw Type
LCD Bezel	M2.5*6.5 (NL)	6	

- 3. Starting from the inside edges, pry the inside of the bezel upwards from the panel. Continue moving left until the bezel is removed. If necessary, use a plastic pry to release the corners of the bezel.



- 
4. Lift up the bezel and remove it from the LCD Module.



## Removing the Inverter Board

1. Remove the LCD Bezel. See "Removing the LCD Bezel" on page 90.
2. Disconnect the left and right Inverter board cables as shown.



3. Lift up the Inverter Board and remove.



# Removing the Camera Module

- 1. Remove the LCD Bezel. See "Removing the LCD Bezel" on page 90.
- 2. Remove the two securing screws from the Camera Module.



Step	Size	Quantity	Screw Type
Camera Module	M2*3 (NL)	1	

- 3. Disconnect the Camera Module cable as shown.



# Removing the LCD Panel

- 1. Remove the LCD Bezel. See "Removing the LCD Bezel" on page 90.
- 2. Remove the six securing screws from the LCD Module.

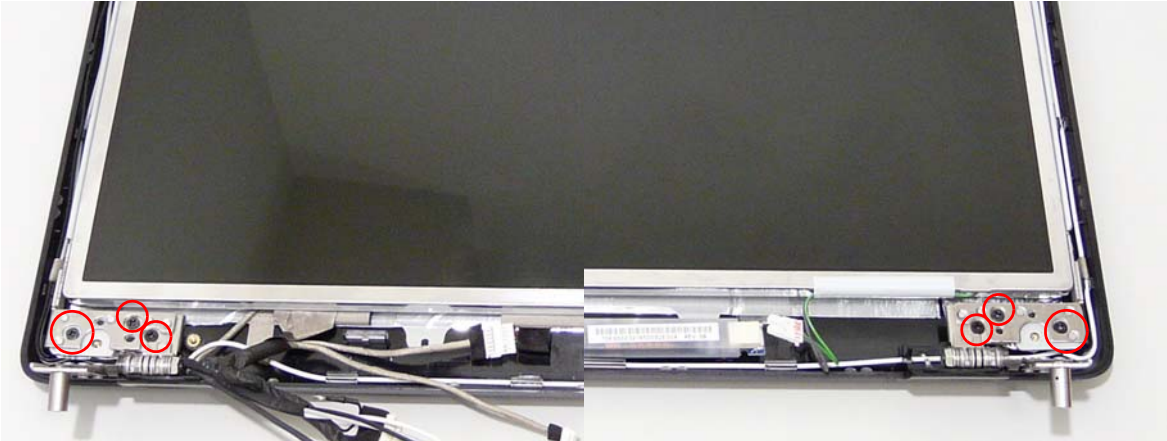

Step	Size	Quantity	Screw Type
LCD Panel	M2.5*6.5 (NL)	6	

- 3. Disconnect the left and right sides of the Inverter cable.



- 4. Disconnect the Camera Module cable as shown.



5. Grasp the panel by both ends and lift to remove.



### Removing the LCD Brackets and FPC Cable

1. Remove the LCD Panel. See “Removing the LCD Panel” on page 93.
2. Turn the LCD panel over to expose the rear. Grip the FPC cable and lift upward to detach the adhesive pads.

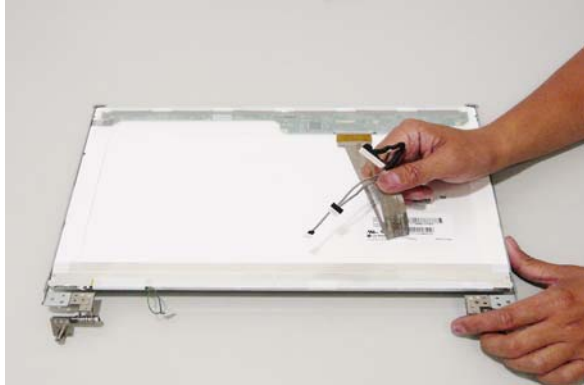

3. Remove the eight securing screws (four on each side) from the LCD Panel brackets.

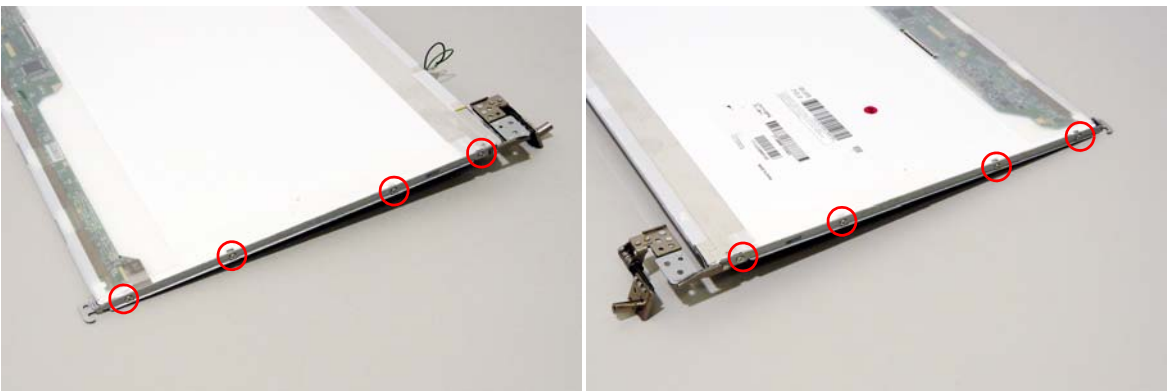

Step	Size	Quantity	Screw Type
LCD Brackets	M2*3 NL	8	



---

4. Remove the LCD brackets by pulling away from the LCD Panel as shown.



---

# LCD Module Reassembly Procedure

## Replacing the LCD Panel

1. Align the LCD brackets with the eight screw holes (four on each side) on the LCD Panel as shown.

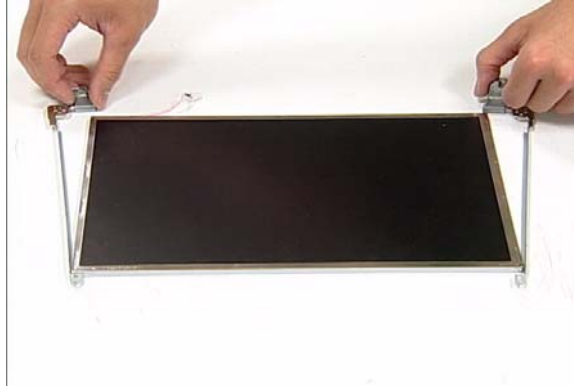

2. Secure the LCD brackets to the LCD panel.

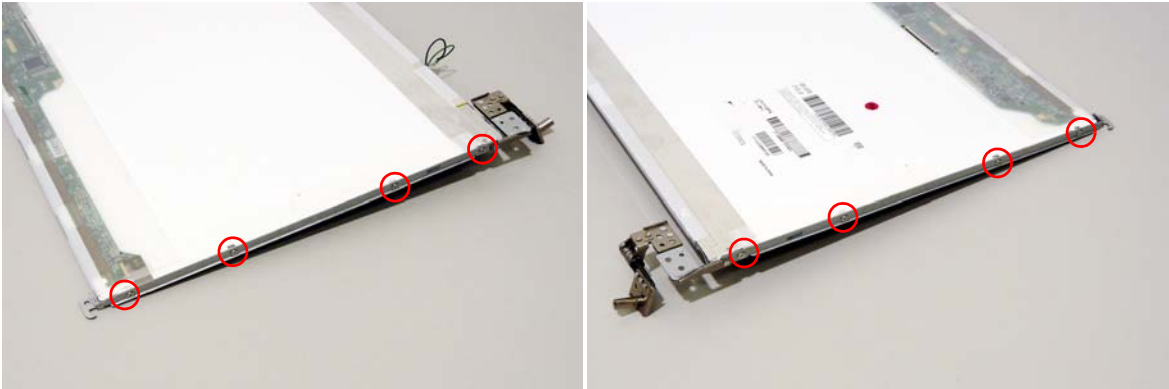

3. Turn the panel over. Insert the LCD Panel cable into the LCD Panel as shown.

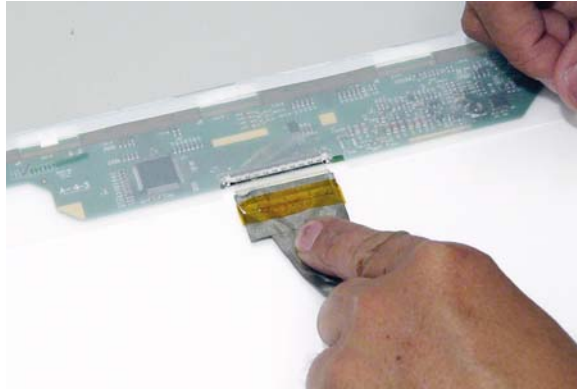

4. Align the LCD Panel cable as shown and press down to secure in place.

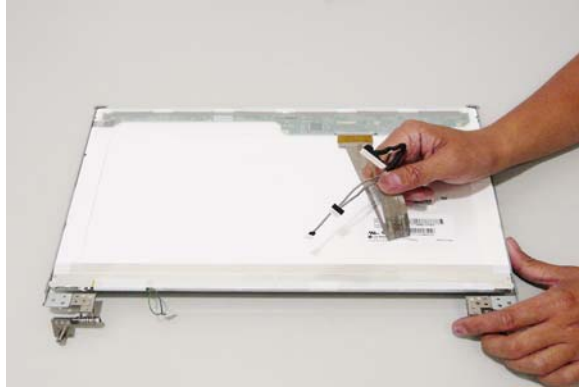

5. Take care to insert the top of the panel first and then angle it in place. 6. Place the LCD Panel in the back cover.



7. Secure the LCD module with the six securing screws.

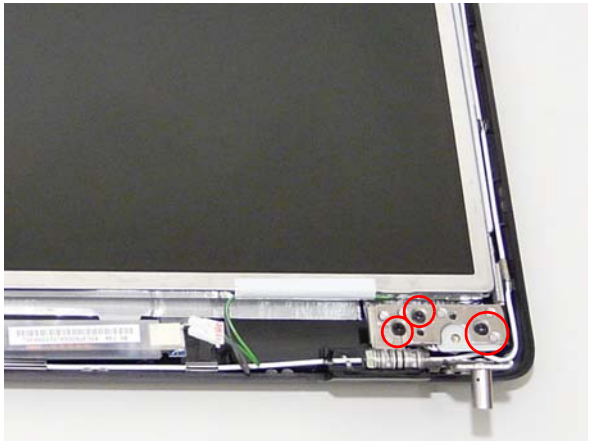

8. Connect the left and right Inverter cables.



9. Connect the camera cable.

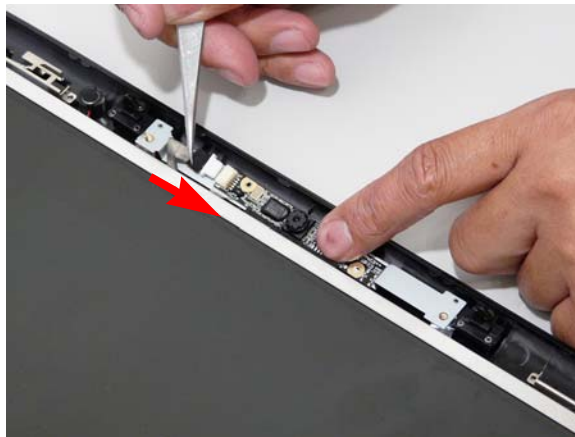

---

## Replacing the LCD Bezel

1. Starting from the bottom, locate the bezel correctly and press down the edges until there are no gaps between the bezel and the LCD Module,



2. Replace the six screws and the rubber screw caps provided.



# Main Module Reassembly Procedure

## Replacing the CPU

1. Carefully turn the mainboard upside down (CPU side up), and insert the CPU into the CPU bracket as shown.
2. Using a plastic screw driver, lock the CPU in the socket as shown.

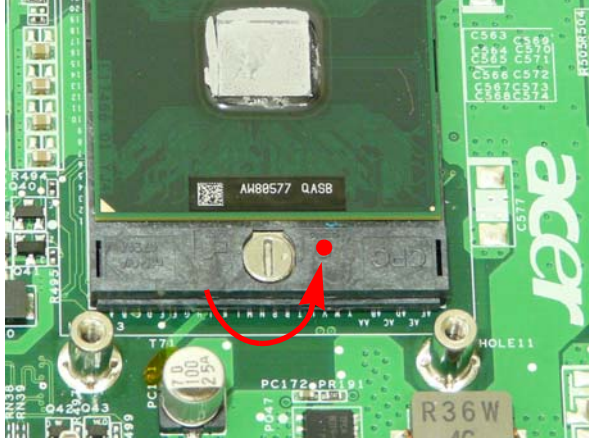

## Replacing the CPU Fan Module

1. Replace the Fan module on the Mainboard.
2. Lift the cover to replace the single screw located in the back of the fan module.

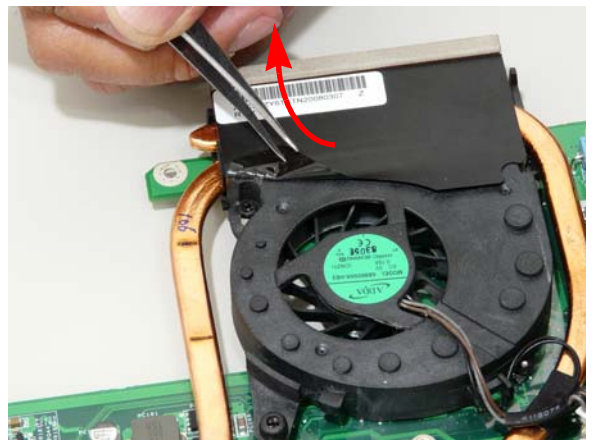
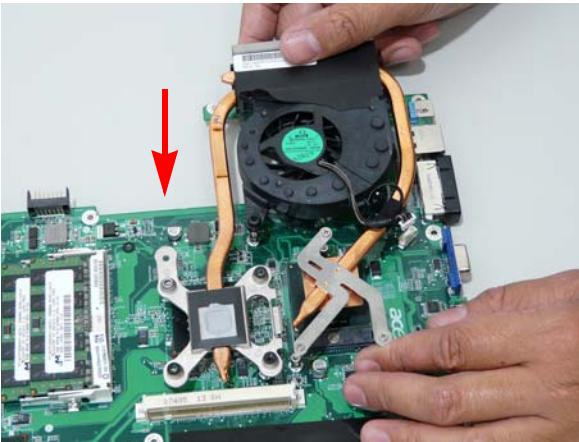

3. Tighten the three captive screws on the heatsink.
4. Connect the Fan cable to the Mainboard.

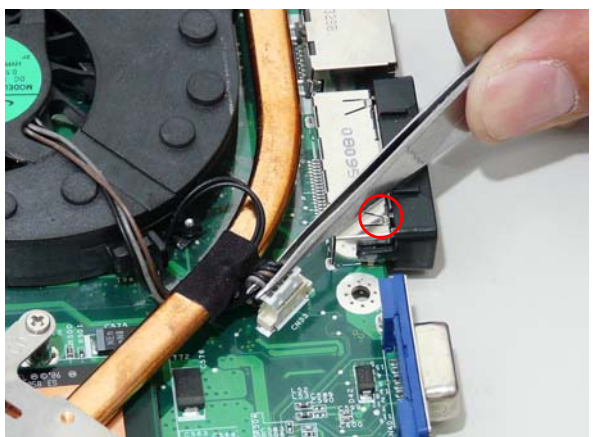
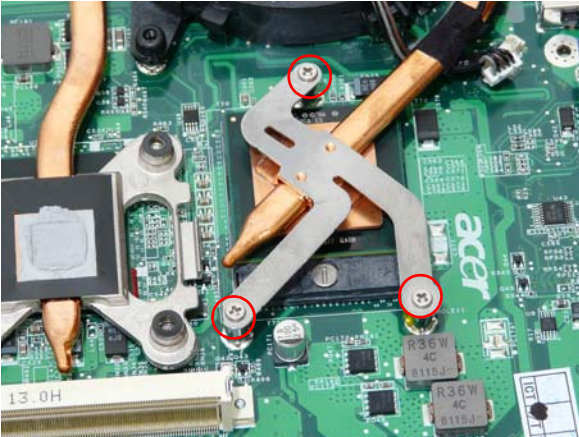

## Replacing the Mainboard

1. Pull the edge of the lower base outward and insert the motherboard in the lower base.
2. Replace the securing screw on the Mainboard.

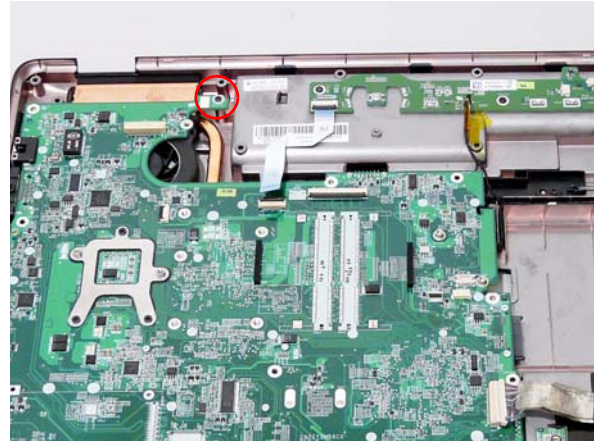
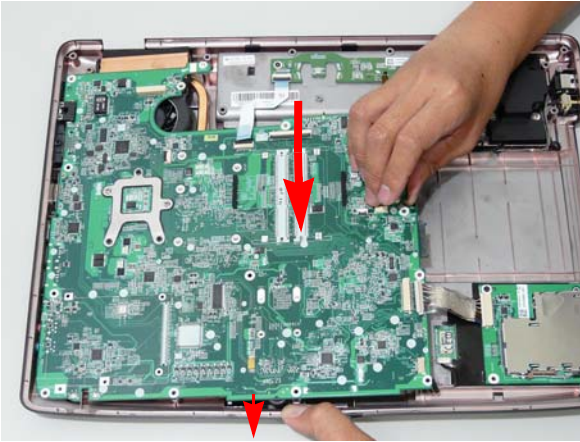

3. Connect the two cables connected to the motherboard.

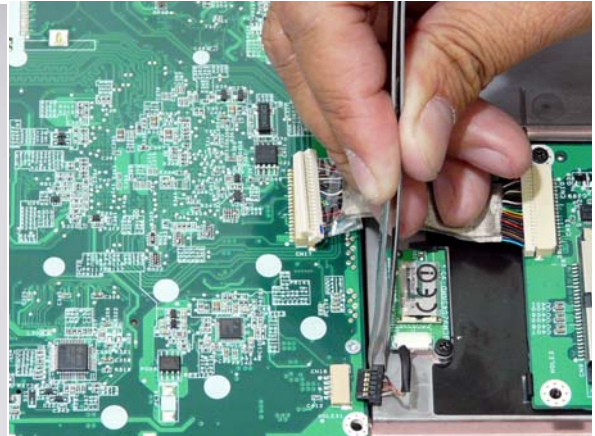

4. Replace the adhesive strip securing the modem cable.

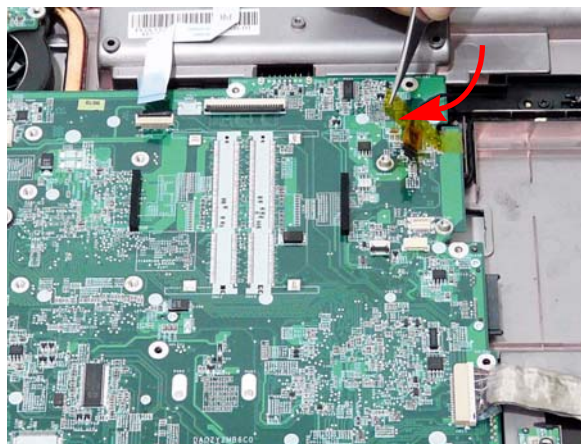

## Replacing the Bluetooth Board

1. Connect one end of the Bluetooth cable to the mainboard as shown.

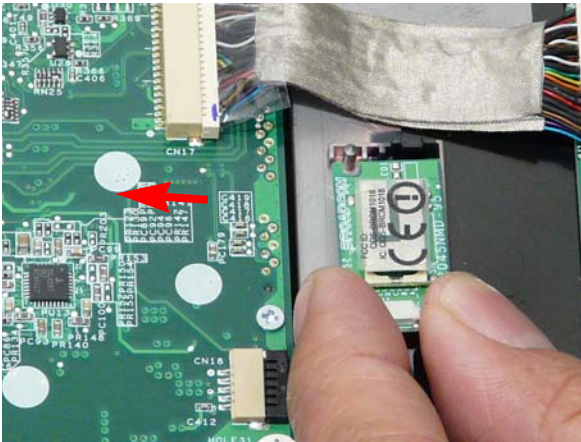

2. Connect the other end of the Bluetooth cable to the Bluetooth Module as shown.

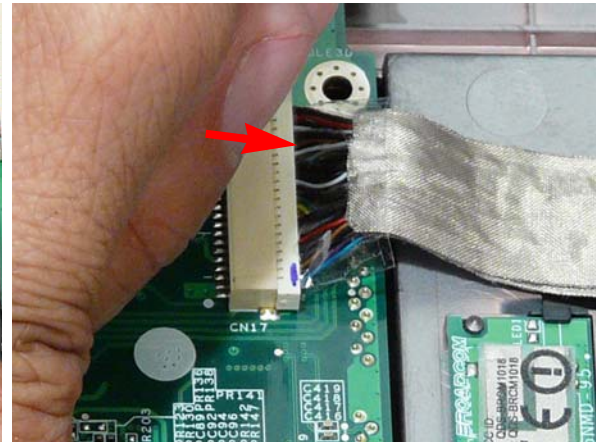

3. Locate the Bluetooth Module and replace the single securing screw.



## Replacing the ExpressCard Module

1. Replace the ExpressCard module on the upper cover.

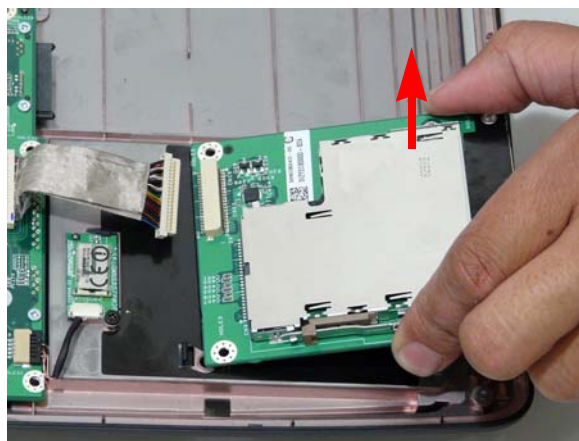

2. Replace the two securing screws.

**IMPORTANT:** The correct location of the ExpressCard Module screws is illustrated in the following image. Do not insert the screws in the remaining screw sockets. They are locations for upper cover screws.



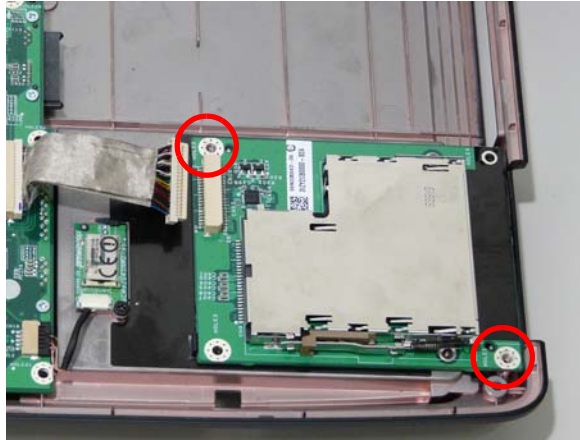

3. Connect the cable connecting the ExpressCard module.

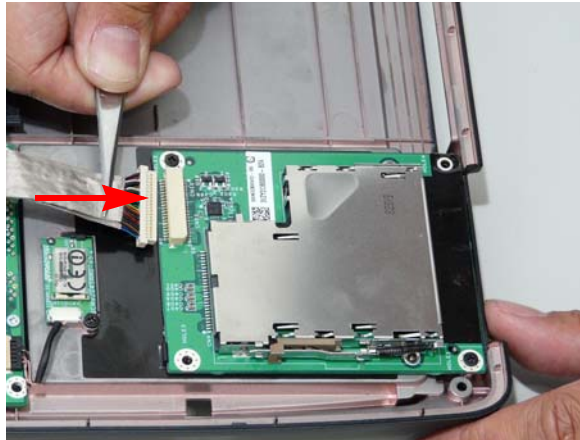

## Replacing the Subwoofer Module

1. Grasp the Subwoofer Module and insert in the lower base.

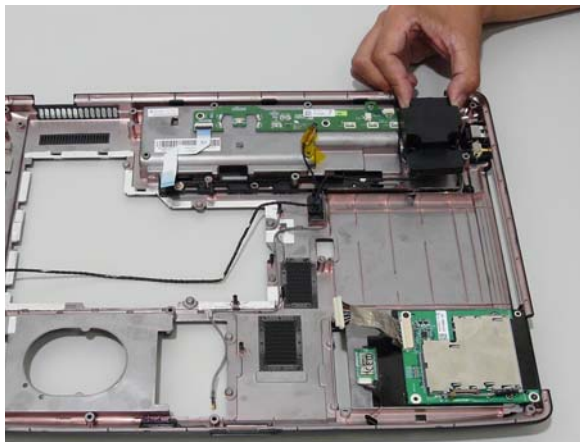

2. Insert the cables under the housing guide as shown.

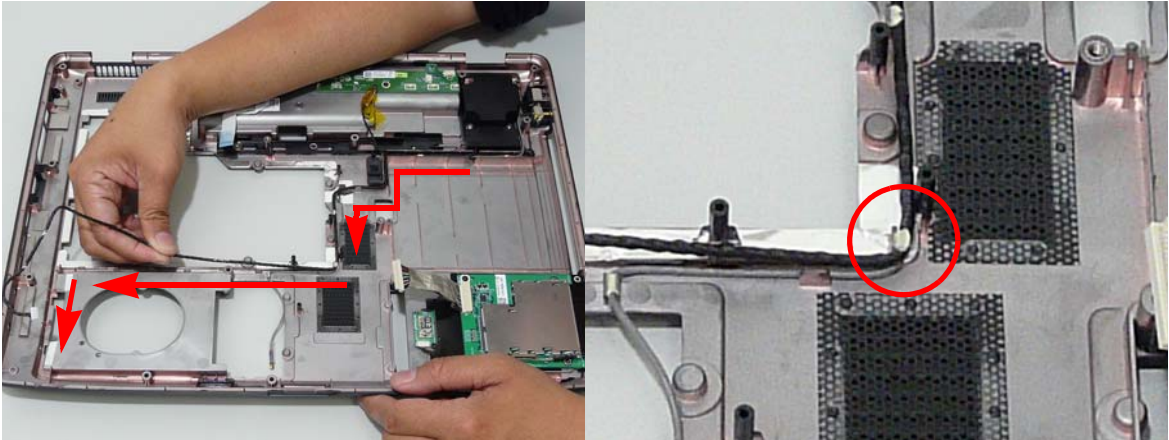

3. Replace the four securing screws on the Subwoofer Module.

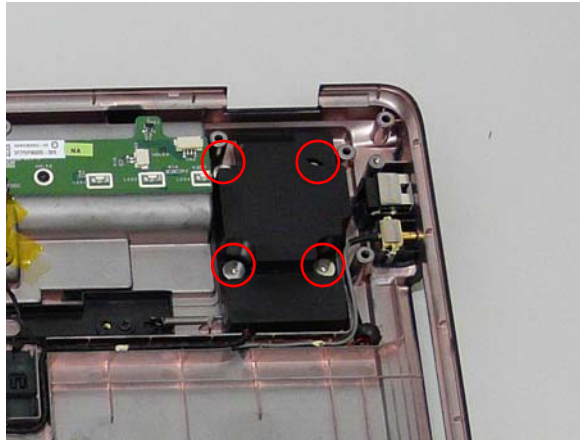

## Replacing the Finger Print Reader

1. Remove the Finger Print Reader board from the Upper Cover.

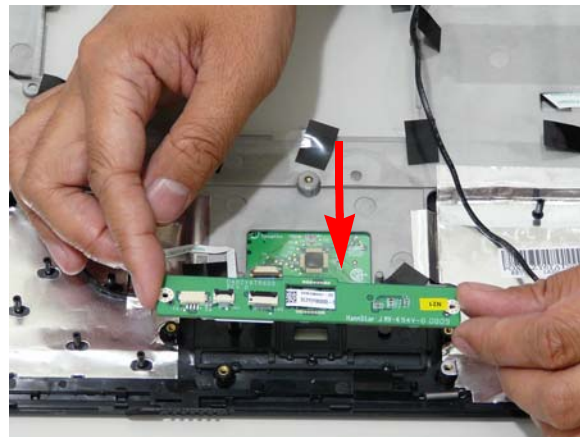

2. Remove the bracket from the board.

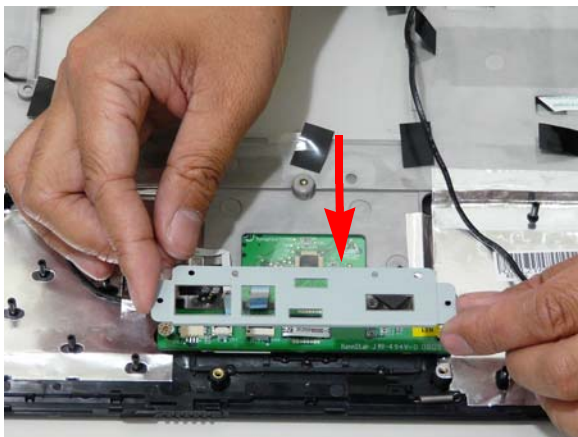

3. Replace the four securing screw on the Finger Print Reader board.

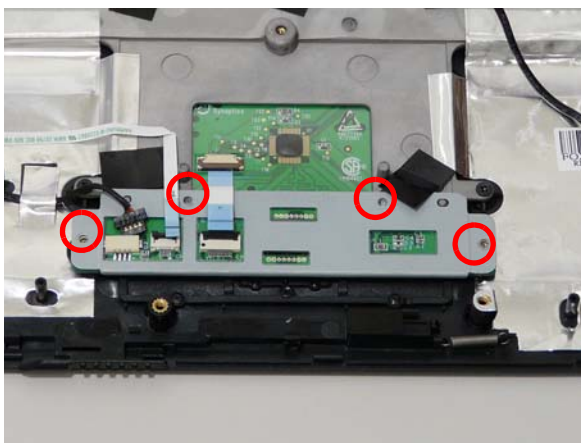

**NOTE:** Move back the cabling to allow for easier access to the screw sockets.

4. Connect the two FFC cables as shown.

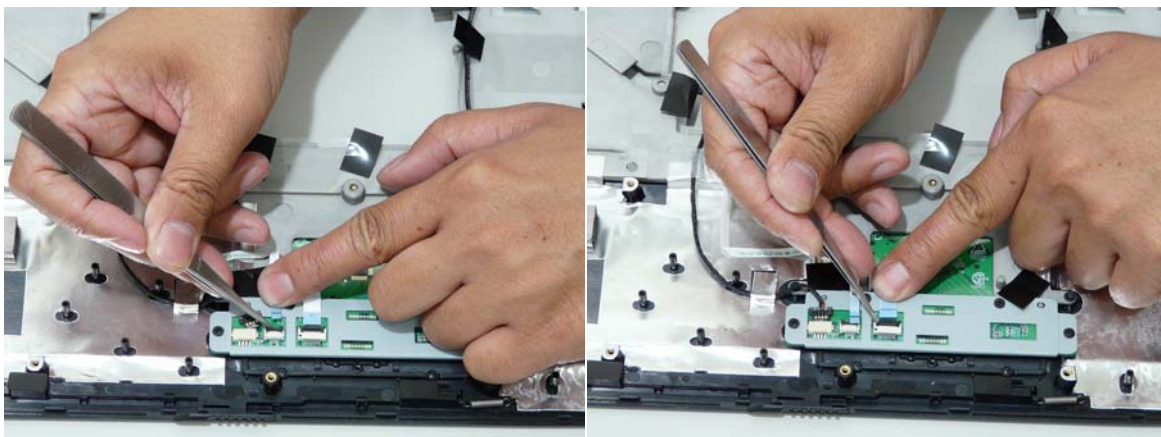

5. Connect the cable as shown.

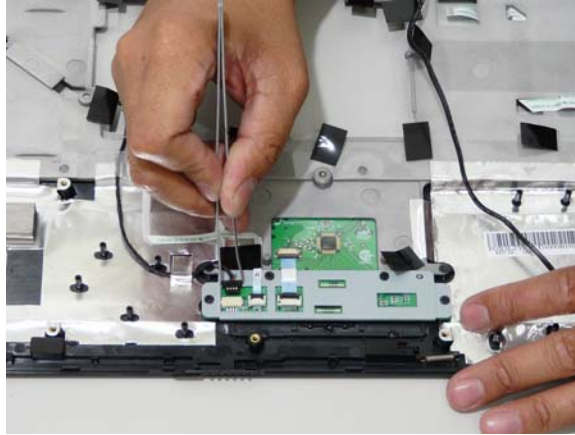

## Replacing the eKey Module

**IMPORTANT:** Take note of the eKey button when installing. It must face down and the cable connector up in order to install the module correctly.

1. Locate and replace the module as shown.

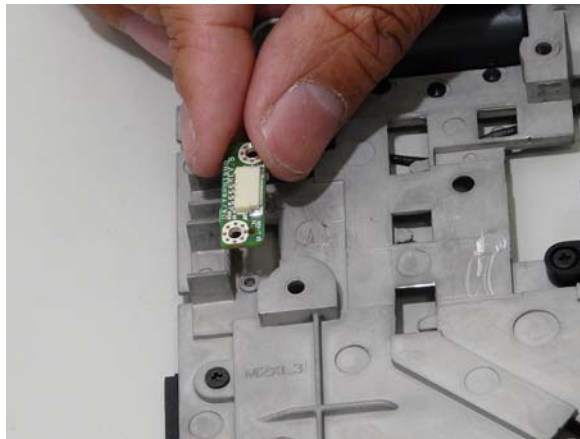

2. Connect the eKey Module cable and replace the two securing screws.

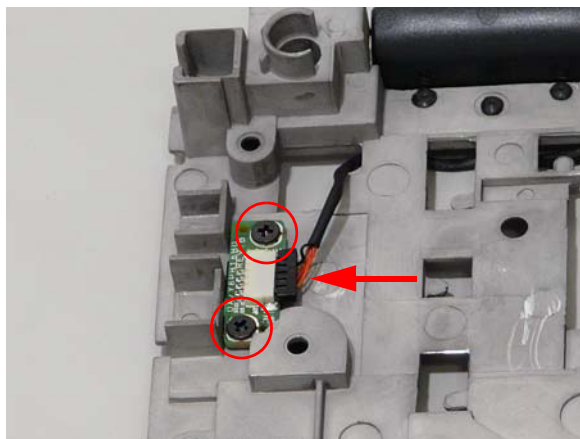

---

## Replacing the Touch Pad

**IMPORTANT:**The Touch Pad cannot be removed individually. To replace the Touch Pad, replace the entire Upper Cover.

1. Connect the Touch Pad cable as shown

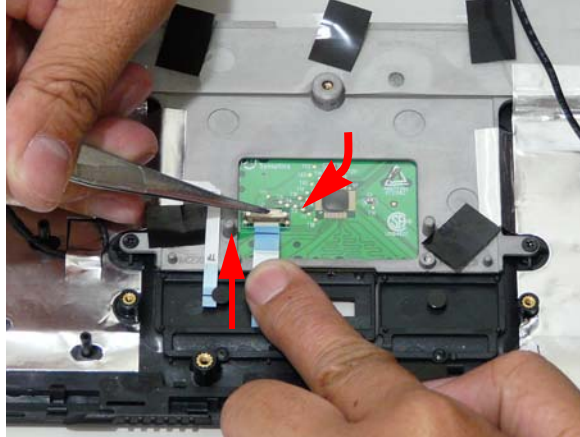

## Replacing the Launch Board

1. Replace the Launch Board on the upper cover.
2. Replace the four securing screws.

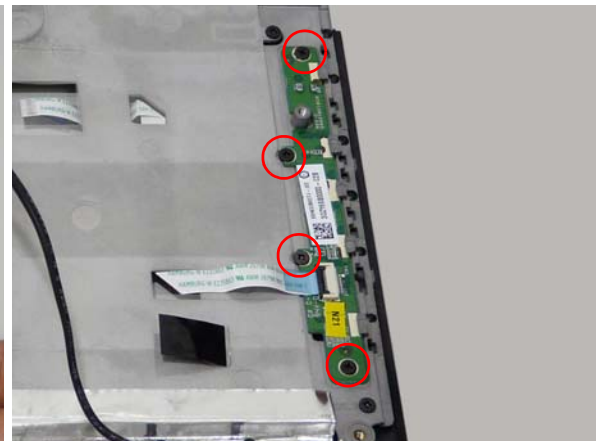
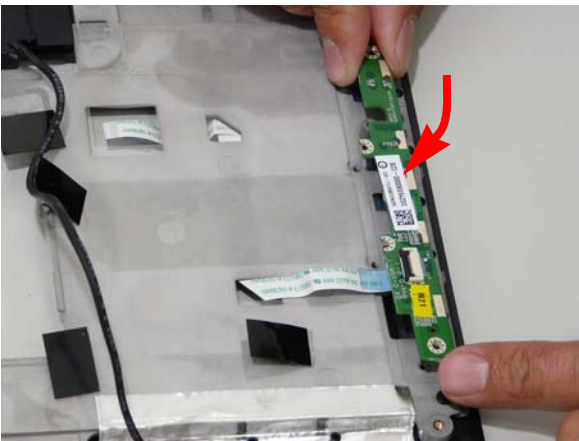

3. Insert the FFC flush with the connector and press down on the locking latch to secure.

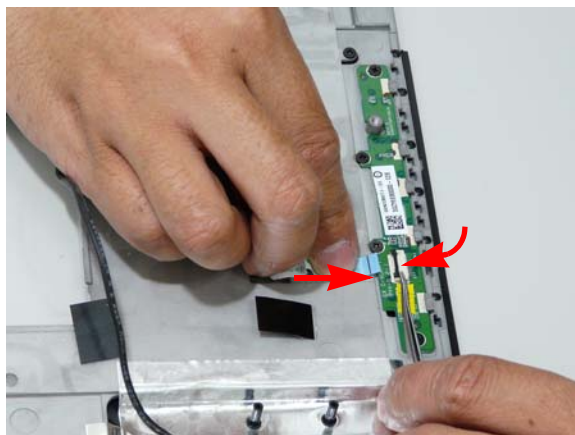

## Replacing the Switch Board

1. Connect the cable to the Switch Board.



2. Insert the eKey board FFC flush with the connect and press down on the locking latch to secure.



3. Replace the two securing screws on the Switch Board.

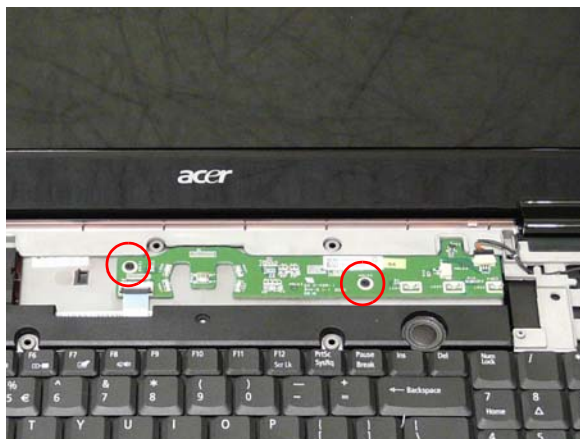

## Replacing the Antenna, MIC and Speaker Cables

**IMPORTANT:** Ensure that all cables pass through the Mainboard and are accessible from the underside of lower cover.

1. Insert the cabling through the housing as shown.
2. Ensure that the cabling is tucked in and secured.

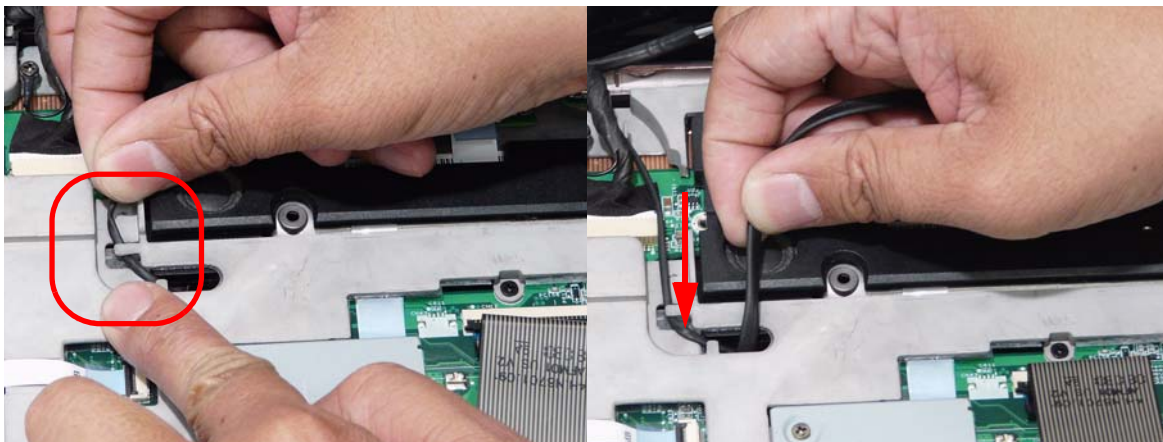

3. Turn the computer on its side, feed cables through to the underside.



4. Place the computer upside down, and insert the MIC and Speaker cables through the HDD housing.

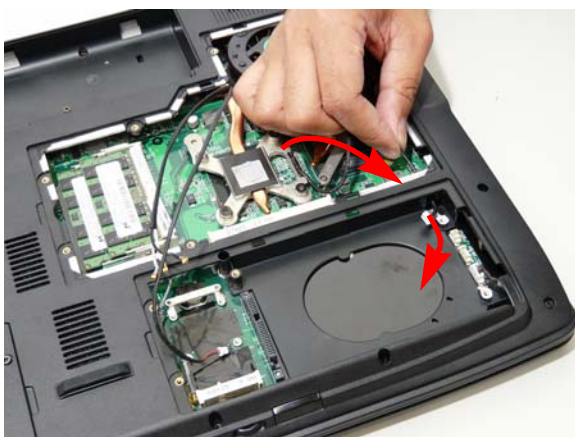

5. Take note of the cabling arrangement. Ensure that the cabling is secured as shown to prevent damage.

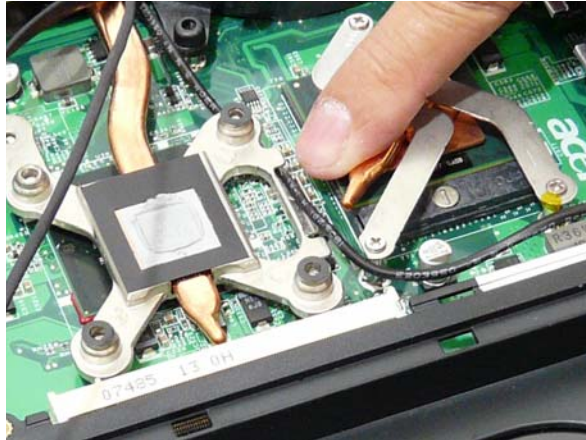

6. Connect the MIC and speaker cables.



7. Gently pull the Antenna Cables through the HDD housing.

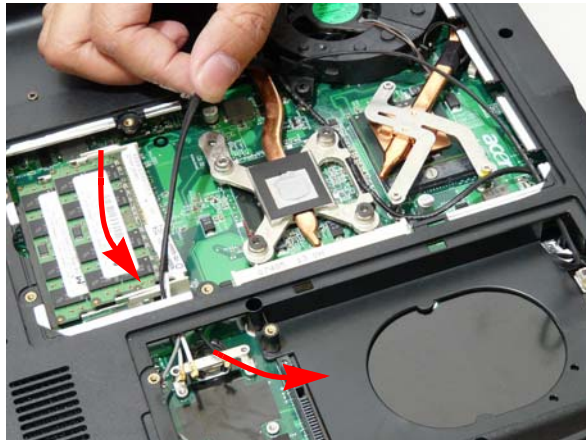



---

## Replacing the Speaker Module

1. Replace the Speaker Module from the upper cover.

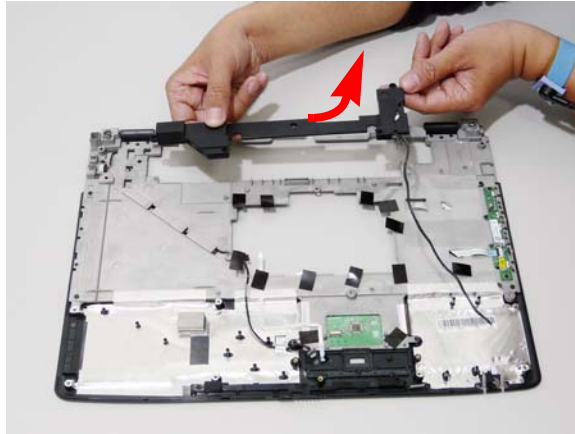

2. Replace the four securing screws connecting the Speaker Module.

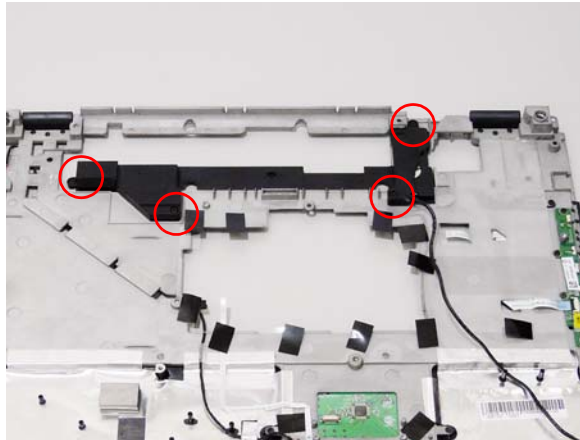

## Replacing the Upper Cover

1. Locate the upper cover over the lower base taking note of the screw sockets.

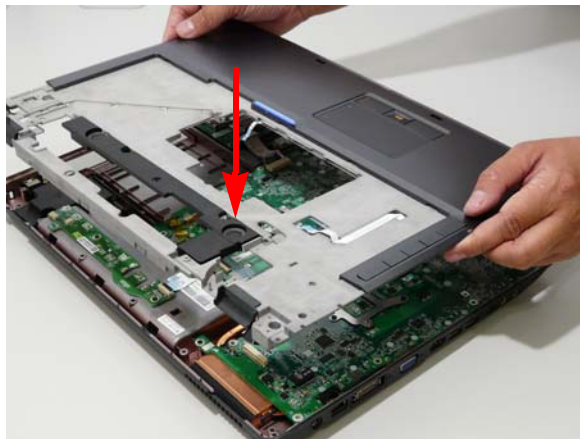

- 
2. Angle the right end of the Upper Cover in place, and insert any remaining cables through the lower base as shown.



3. Set the Upper Cover down on the lower base.

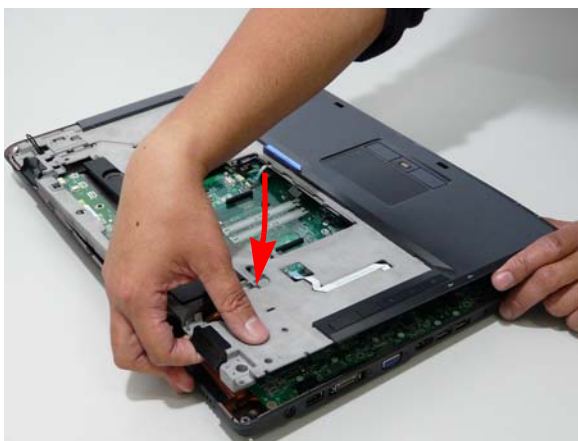

4. Replace the four securing screws on the Upper Cover.

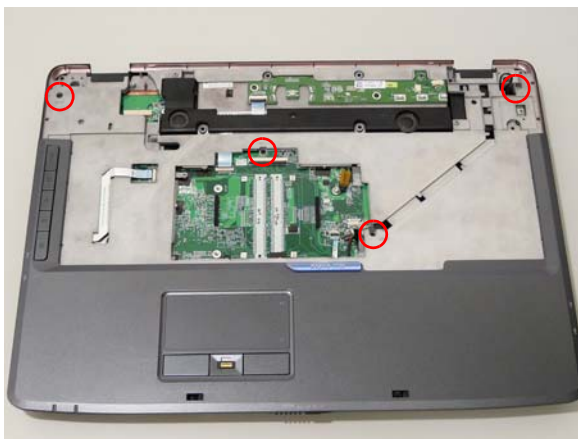

5. Connect the five cables from the mainboard as shown.

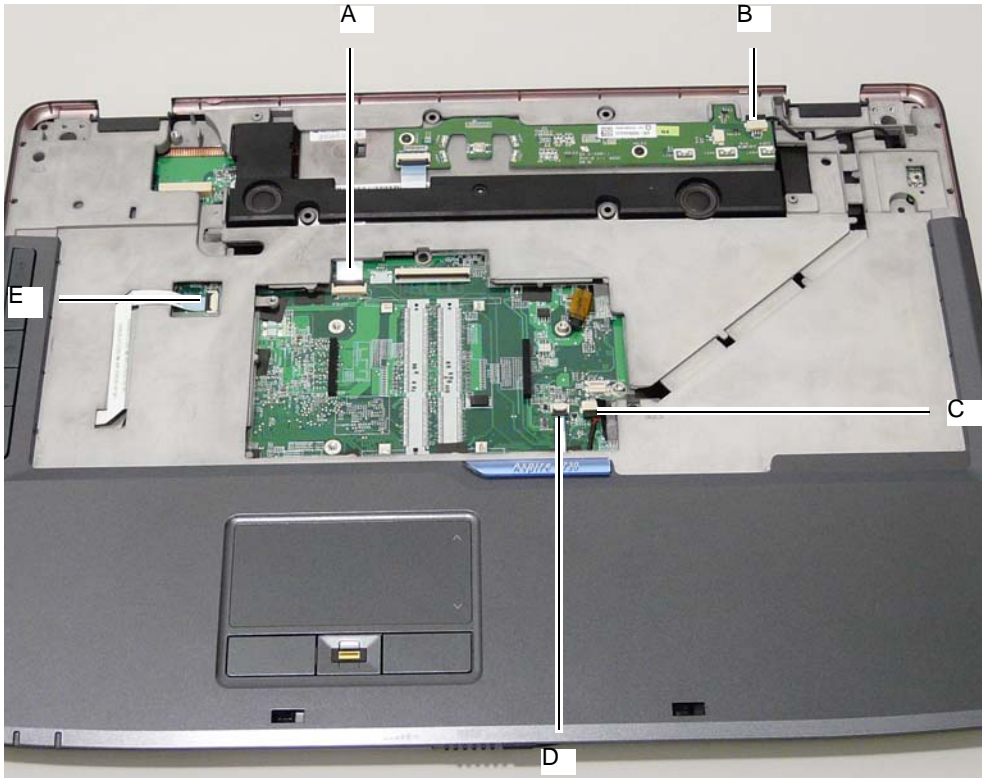

**IMPORTANT:**When removing cables, always hold the cable by the pull-tab or by the connector. Do not hold the pull by the cable itself to prevent stripping.

Connect A as shown.

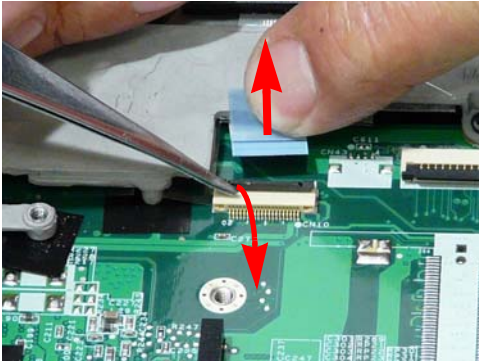

Connect B as shown.

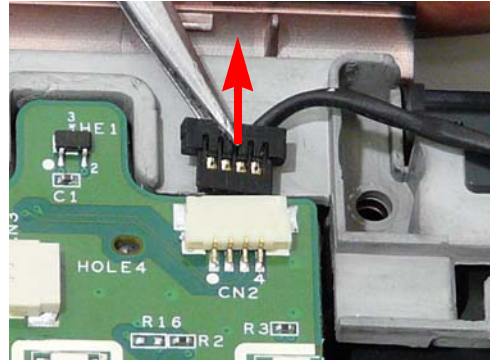

Connect C as shown.



Connect D as shown.

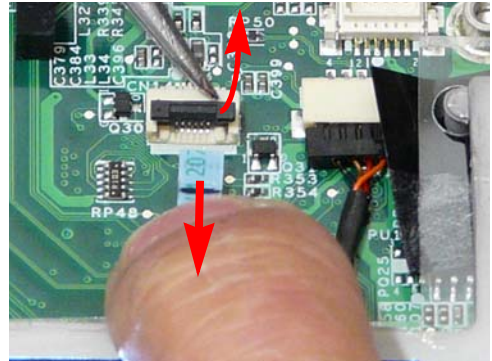

Connect E as shown.

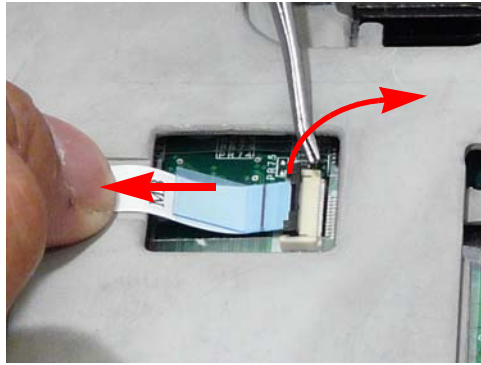

6. Angle the keyboard plate to insert.



7. Tighten the captive screw on the keyboard plate.

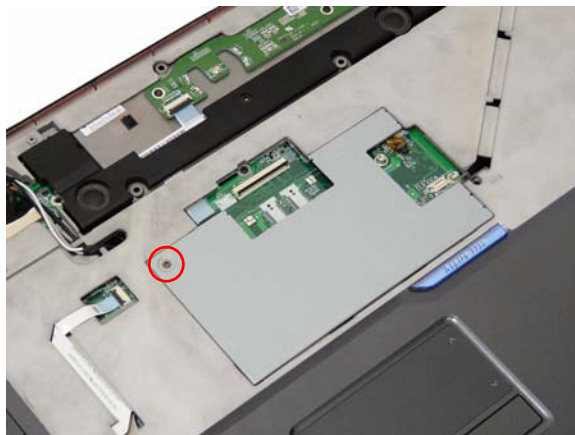

- 
- Turn the computer upside down and replace the eleven securing screws on the bottom panel to attach the bottom and lower covers.

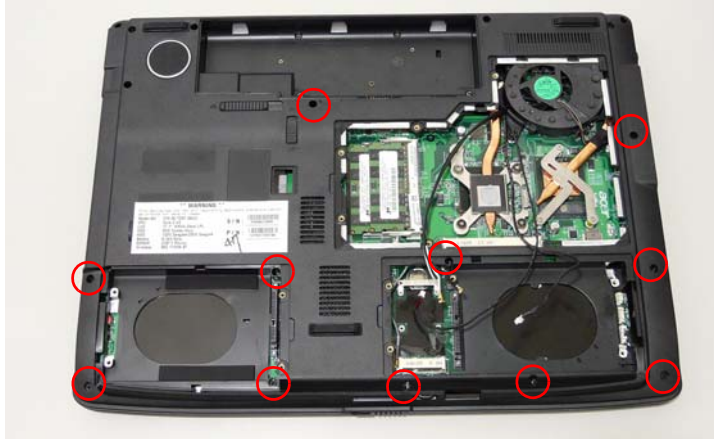

## Replacing the Modem Module

- Angle the Modem Module in place and attach to the connector.

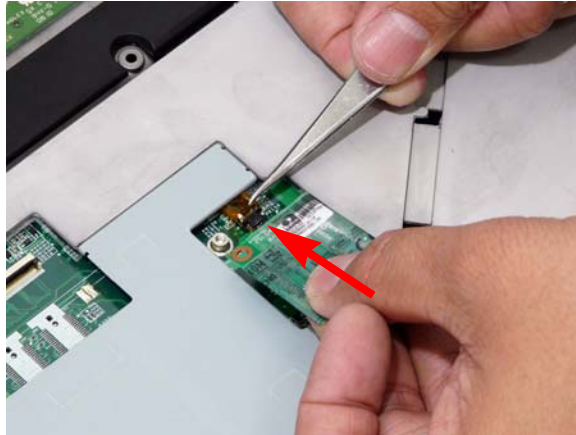

- Insert the module and replace the two securing screws.



## Replacing the Keyboard

1. Replace keyboard cable to the mainboard, and secure the locking latch.
2. Turn the keyboard over and place the front edge first in the mounting.

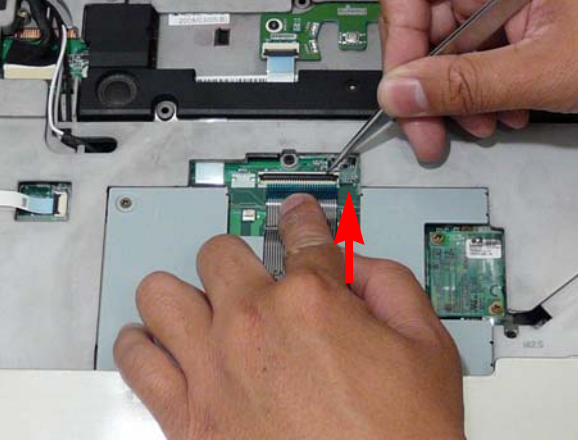

3. Press down on the areas marked below to secure in place.



---

## Replacing the Switch Cover

1. Replace the Switch cover, and press down to secure in place.



2. Turn the computer over and replace the nine securing screws.

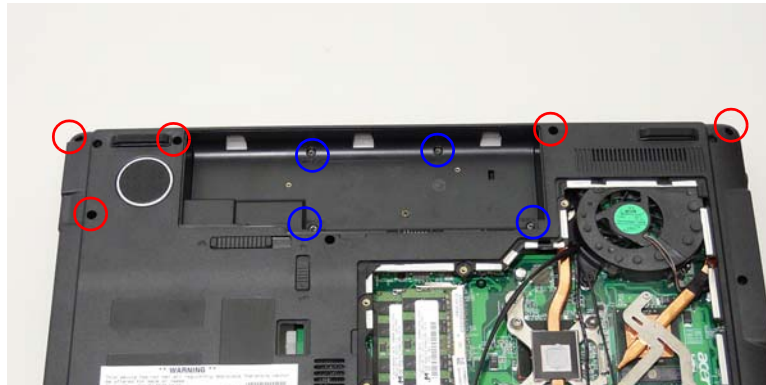

## Replacing the ODD Module

1. Insert a pin in the eject hole of the ODD to eject the ODD tray.
2. Press the cover into the tray, bottom edge first, to secure.



3. Turn ODD Module around and secure bracket with two screws.
4. Slide Module in chassis and press until Module is flush with chassis.

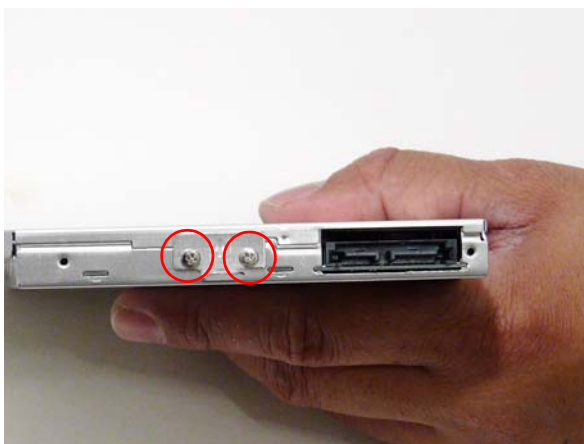

5. Replace the ODD Cap and secure the single captive screw.





# Replacing the Hard Disk Drive2 Module

1. Replace the connector on the HDD.



2. Place the HDD in the HDD carrier.



3. Replace the four screws (two each side) to secure the carrier.

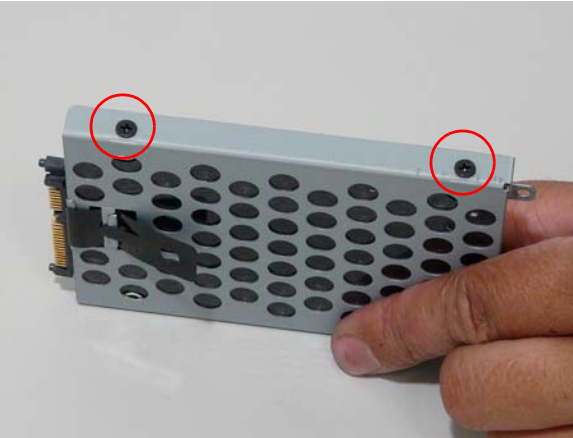

4. Insert the HDD, right side first, and push down to locate the interface correctly.



5. Replace the two securing screws.



# Replacing the Hard Disk Drive1 Module

1. Replace the connector on the HDD.

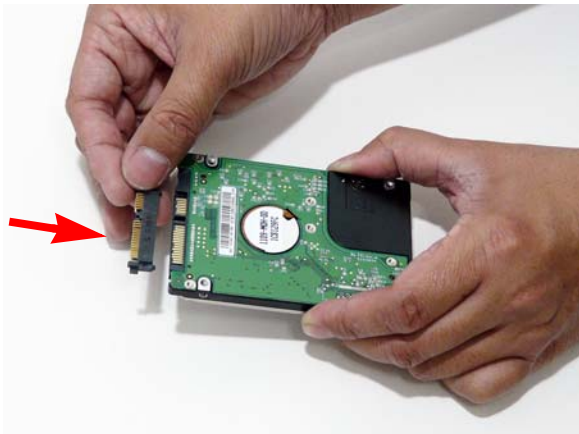

2. Place the HDD in the HDD carrier.



3. Replace the four screws (two each side) to secure the carrier.

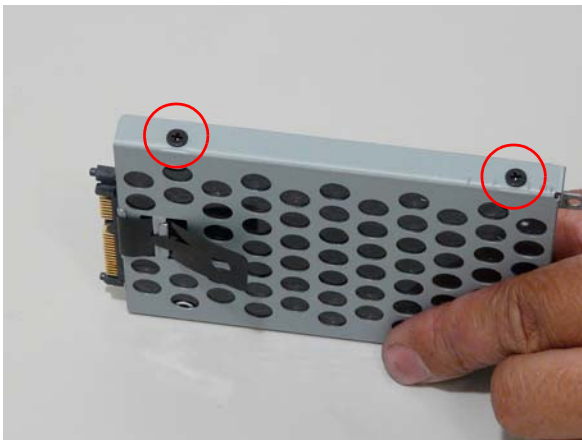

4. Insert the HDD, left side first, and push down to locate the interface correctly.



5. Replace the two securing screws.



## Replacing the WLAN Board

1. Insert the WLAN board in to the socket.



2. Push the board down and replace the two securing screws.



3. Replace the three antenna cables.

**NOTE:** The following is the correct cable-color to connector designation: TR1 (left) to White, TR3 (middle) to Gray, and TR2 (right) to Black.



# Replacing the TV Tuner Module

1. Insert the TV Tuner board in to the socket.

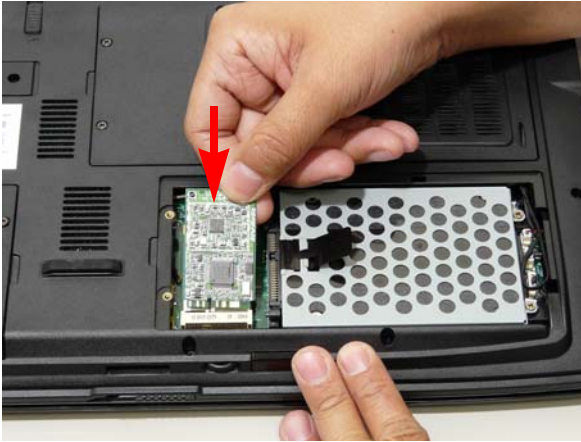

2. Attach the bracket to the module.



3. Replace the three securing screws.

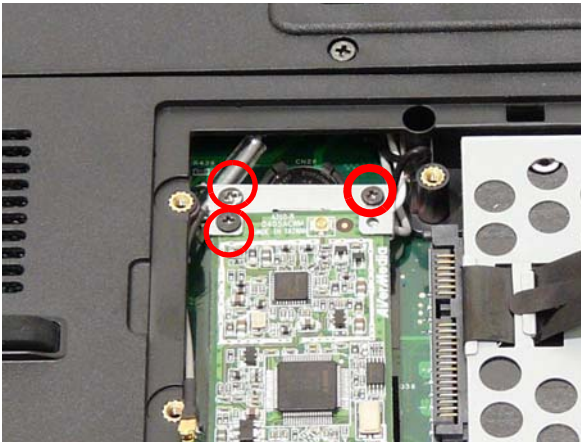

4. Replace the antenna cable.

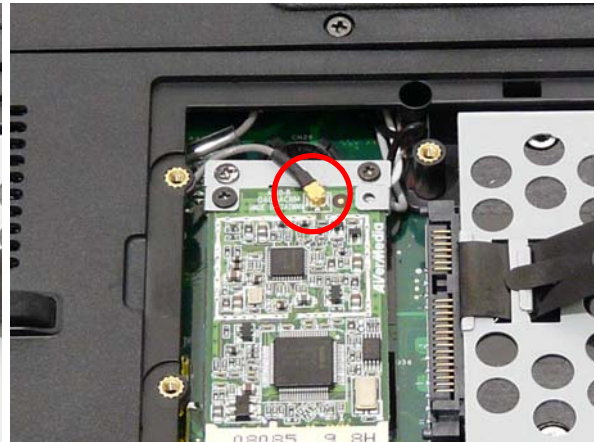

## Replacing the Turbo Ram Module.

1. Insert the Turbo Ram board in to the socket.



2. Attach the bracket to the module.



3. Replace the three securing screws.

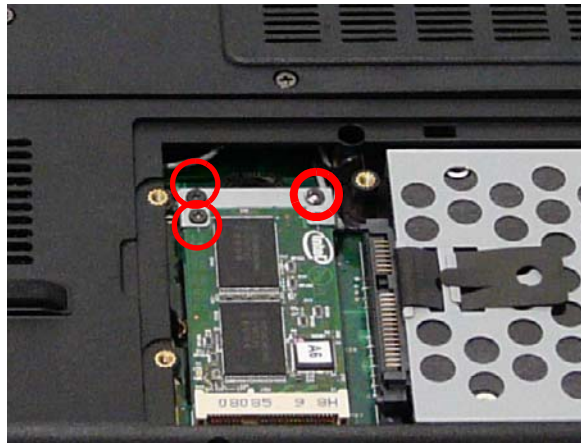

## Replacing the MXM Module

1. Insert the MXM board in to the socket.

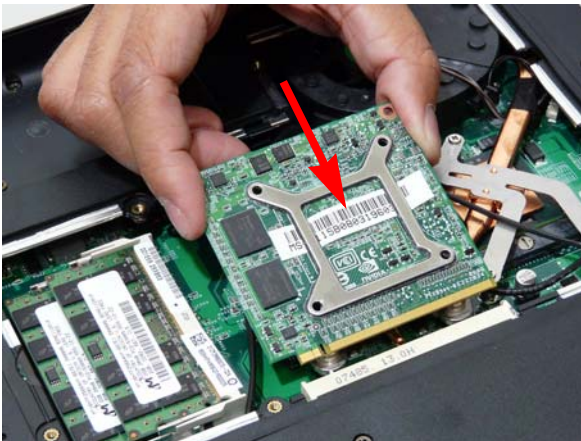

2. Replace the four securing screws.

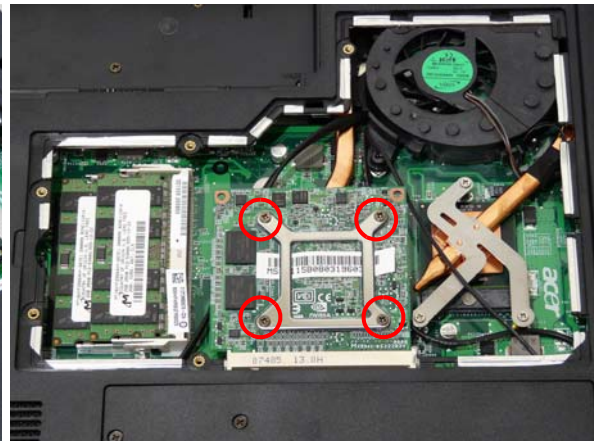

## Replacing the DIMM Modules

1. Insert DIMM1 in to the socket.



2. Press down to locate DIMM correctly.



3. Repeat steps 1 and 2 for the second DIMM module.

## Replacing the Lower Covers

1. Replace the HDD2 cover.



2. Replace the HDD1 cover.



3. Replace the Memory cover.



4. Secure the ten captive screws in the covers.

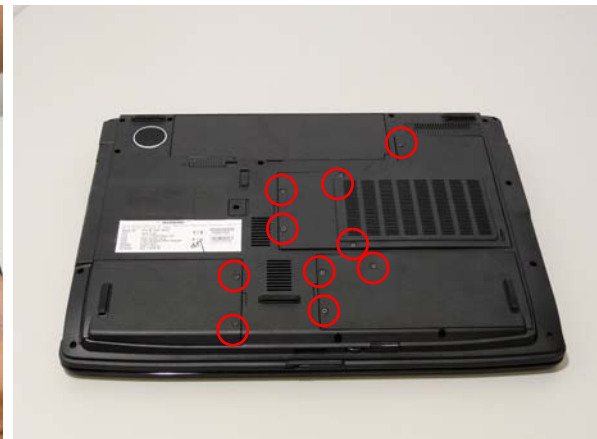

---

## Replacing the ExpressCard Dummy Tray

1. Insert the ExpressCard dummy as shown.



2. Push into the slot until flush with the chassis cover.



## Replacing the SD Dummy Tray

1. Insert the SD dummy as shown.



2. Push into the slot until flush with the chassis cover.



## Replacing the Battery

1. Slide and hold the battery release latch (1), insert battery in to the main unit (2).



2. Slide the battery lock/unlock latch to the lock position.







# Troubleshooting

---

## Common Problems

Use the following procedure as a guide for computer problems.

**NOTE:** The diagnostic tests are intended to test only Acer products. Non-Acer products, prototype cards, or modified options can give false errors and invalid system responses.

1. Obtain the failing symptoms in as much detail as possible.
2. Verify the symptoms by attempting to re-create the failure by running the diagnostic test or by repeating the same operation.
3. Use the following table with the verified symptom to determine which page to go to.

Symptoms (Verified)	Go To
Power On Issue	Page 128
No Display Issue	Page 129
LCD Failure	Page 131
Internal Keyboard Failure	Page 131
Touch Pad Failure	Page 132
Internal Speaker Failure	Page 132
Internal Microphone Failure	Page 134
ODD Failure	Page 136
Rightside USB Failure	Page 139
Modem Failure	Page 139
WLAN Failure	Page 140
Acer EasyLaunch Button Failure	Page 140
Acer MediaTouch Failure	Page 141
Fingerprint Reader Failure	Page 141
Thermal Unit Failure	Page 142
HDTV Switch Failure	Page 142
Other Functions Failure	Page 143
Intermittent Failures	Page 144
Undermined Failures	Page 144

4. If the Issue is still not resolved, see "Online Support Information" on page 197.

---

## Power On Issue

If the system doesn't power on, perform the following actions one at a time to correct the problem. Do not replace a non-defective FRUs:

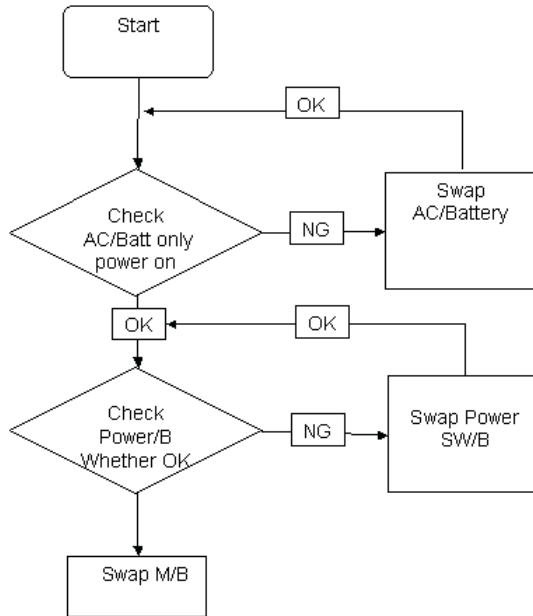

## Computer Shutdown Intermittently

If the system powers off at intervals, perform the following actions one at a time to correct the problem.

1. Check the power cable is properly connected to the computer and the electrical outlet.
2. Remove any extension cables between the computer and the outlet.
3. Remove any surge protectors between the computer and the electrical outlet. Plug the computer directly into a known good electrical outlet.
4. Disconnect the power and open the casing to check the Thermal Unit (see "Thermal Unit Failure" on page 142) and fan airways are free of obstructions.
5. Disable the power management settings in the BIOS to ensure they are not the cause of the problem (see "Power" on page 35).
6. Remove all external and non-essential hardware connected to the computer that are not necessary to boot the computer to the failure point.
7. Remove any recently installed software.
8. If the Issue is still not resolved, see "Online Support Information" on page 197.

## No Display Issue

If the **Display** doesn't work, perform the following actions one at a time to correct the problem. Do not replace a non-defective FRUs:

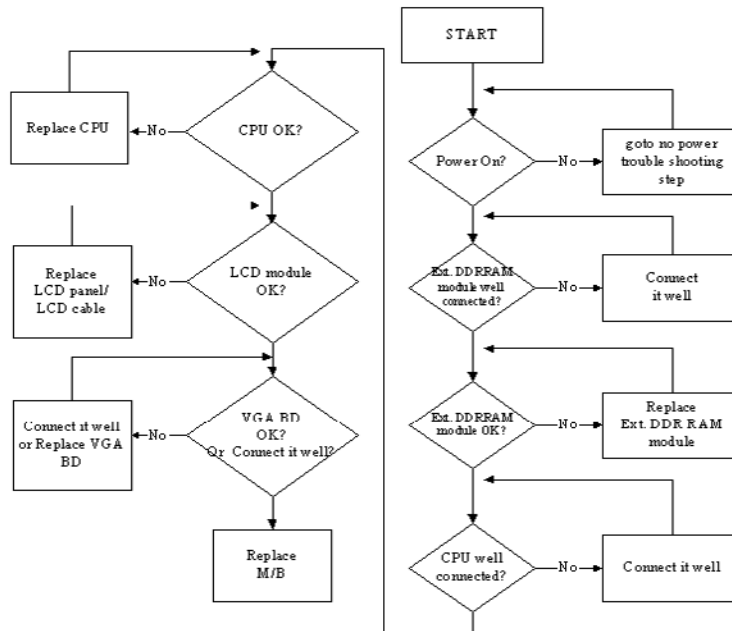

## No POST or Video

If the POST or video doesn't display, perform the following actions one at a time to correct the problem.

1. Make sure that the internal display is selected. On this notebook model, switching between the internal display and the external display is done by pressing **Fn+F5**. Reference Product pages for specific model procedures.
2. Make sure the computer has power by checking at least one of the following occurs:
  - Fans start up
  - Status LEDs light up

If there is no power, see "Power On Issue" on page 128.

3. Drain any stored power by removing the power cable and battery and holding down the power button for 10 seconds. Reconnect the power and reboot the computer.
4. Connect an external monitor to the computer and switch between the internal display and the external display is by pressing **Fn+F5** (on this model).

If the POST or video appears on the external display, see "LCD Failure" on page 131.

5. Disconnect power and all external devices including port replicators or docking stations. Remove any memory cards and CD/DVD discs. Restart the computer.

If the computer boots correctly, add the devices one by one until the failure point is discovered.

6. Reseat the memory modules.
7. Remove the drives (see "Disassembly Process" on page 44).
8. If the Issue is still not resolved, see "Online Support Information" on page 197.

---

## Abnormal Video Display

If video displays abnormally, perform the following actions one at a time to correct the problem.

1. Reboot the computer.
2. If permanent vertical/horizontal lines or dark spots display in the same location, the LCD is faulty and should be replaced. See “Disassembly Process” on page 44.
3. If extensive pixel damage is present (different colored spots in the same locations on the screen), the LCD is faulty and should be replaced. See “Disassembly Process” on page 44.
4. Adjust the brightness to its highest level. See the User Manual for instructions on adjusting settings.  
**NOTE:** Ensure that the computer is not running on battery alone as this may reduce display brightness.  
If the display is too dim at the highest brightness setting, the LCD is faulty and should be replaced. See “Disassembly Process” on page 44.
5. Check the display resolution is correctly configured:
  - a. Minimize or close all Windows.
  - b. If display size is only abnormal in an application, check the view settings and control/mouse wheel zoom feature in the application.
  - c. If desktop display resolution is not normal, right-click on the desktop and select **Personalize**→ **Display Settings**.
  - d. Click and drag the Resolution slider to the desired resolution.
  - e. Click **Apply** and check the display. Readjust if necessary.
6. Roll back the video driver to the previous version if updated.
7. Remove and reinstall the video driver.
8. Check the Device Manager to determine that:
  - The device is properly installed. There are no red Xs or yellow exclamation marks.
  - There are no device conflicts.
  - No hardware is listed under Other Devices.
9. If the Issue is still not resolved, see “Online Support Information” on page 197.
10. Run the Windows Memory Diagnostic from the operating system DVD and follow the onscreen prompts.
11. If the Issue is still not resolved, see “Online Support Information” on page 197.

## Random Loss of BIOS Settings

If the computer is experiencing intermittent loss of BIOS information, perform the following actions one at a time to correct the problem.

1. If the computer is more than one year old, replace the CMOS battery.
2. Run a complete virus scan using up-to-date software to ensure the computer is virus free.
3. If the computer is experiencing HDD or ODD BIOS information loss, disconnect and reconnect the power and data cables between devices.  
If the BIOS settings are still lost, replace the cables.
4. If HDD information is missing from the BIOS, the drive may be defective and should be replaced.
5. Replace the Motherboard.
6. If the Issue is still not resolved, see “Online Support Information” on page 197.

---

## LCD Failure

If the **LCD** fails, perform the following actions one at a time to correct the problem. Do not replace a non-defective FRUs:

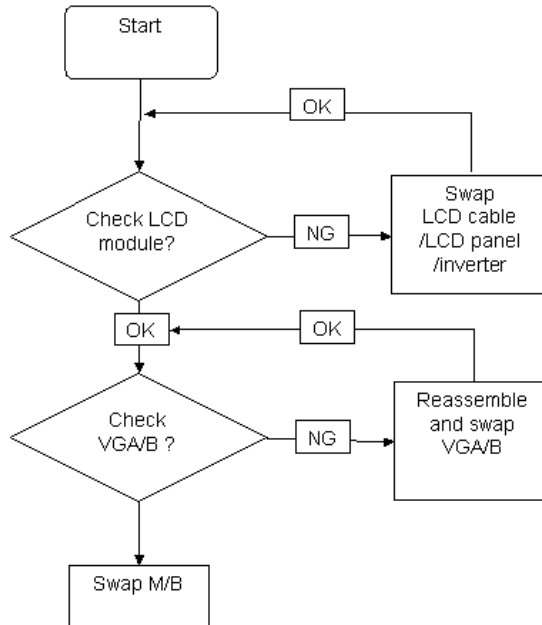

## Built-In Keyboard Failure

If the built-in **Keyboard** fails, perform the following actions one at a time to correct the problem. Do not replace a non-defective FRUs:

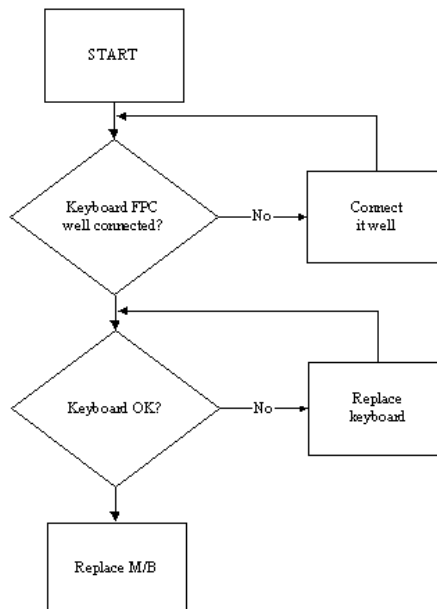

# Touch Pad Failure

If the **Touch Pad** doesn't work, perform the following actions one at a time to correct the problem. Do not replace a non-defective FRUs:

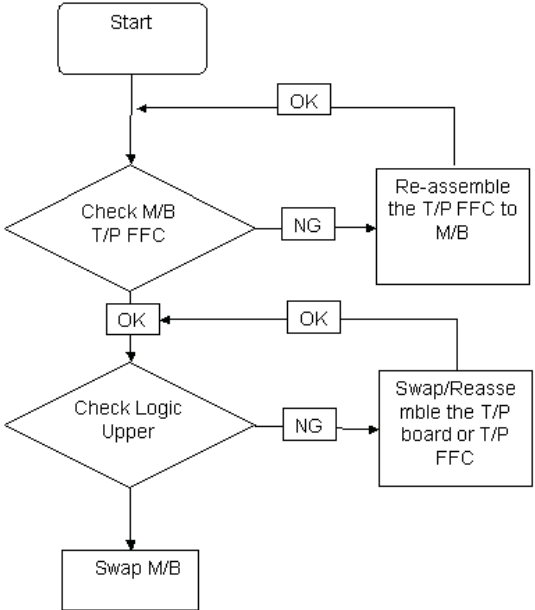

# Internal Speaker Failure

If the internal **Speakers** fail, perform the following actions one at a time to correct the problem. Do not replace a non-defective FRUs:

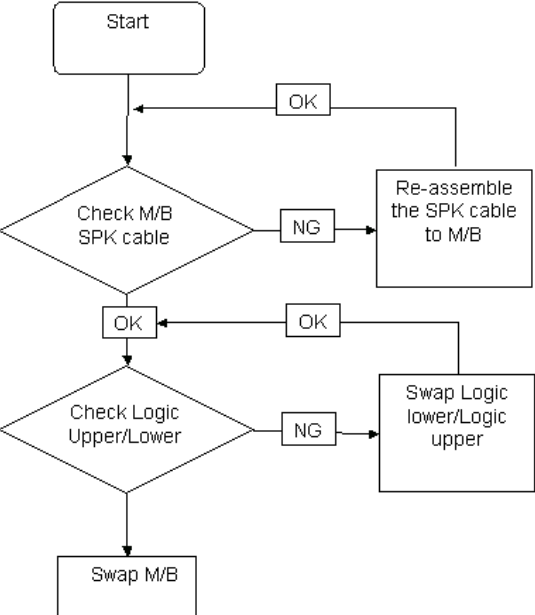

---

## Sound Problems

If sound problems are experienced, perform the following actions one at a time to correct the problem.

1. Reboot the computer.
2. Navigate to **Start** → **Control Panel** → **System and Maintenance** → **System** → **Device Manager**. Check the Device Manager to determine that:
  - The device is properly installed.
  - There are no red Xs or yellow exclamation marks.
  - There are no device conflicts.
  - No hardware is listed under Other Devices.
3. Roll back the audio driver to the previous version, if updated recently.
4. Remove and reinstall the audio driver.
5. Ensure that all volume controls are set mid range:
  - a. Click the volume icon on the taskbar and drag the slider to 50. Ensure that the volume is not muted.
  - b. Click Mixer to verify that other audio applications are set to 50 and not muted.
6. Navigate to **Start** → **Control Panel** → **Hardware and Sound** → **Sound**. Ensure that Speakers are selected as the default audio device (green check mark).

**NOTE:** If Speakers does not show, right-click on the **Playback** tab and select **Show Disabled Devices** (clear by default).
7. Select Speakers and click **Configure** to start **Speaker Setup**. Follow the onscreen prompts to configure the speakers.
8. Remove and recently installed hardware or software.
9. Restore system and file settings from a known good date using **System Restore**.

If the issue is not fixed, repeat the preceding steps and select an earlier time and date.
10. Reinstall the Operating System.
11. If the Issue is still not resolved, see “Online Support Information” on page 197.

# Internal Microphone Failure

If the internal **Microphone** fails, perform the following actions one at a time to correct the problem. Do not replace a non-defective FRUs:

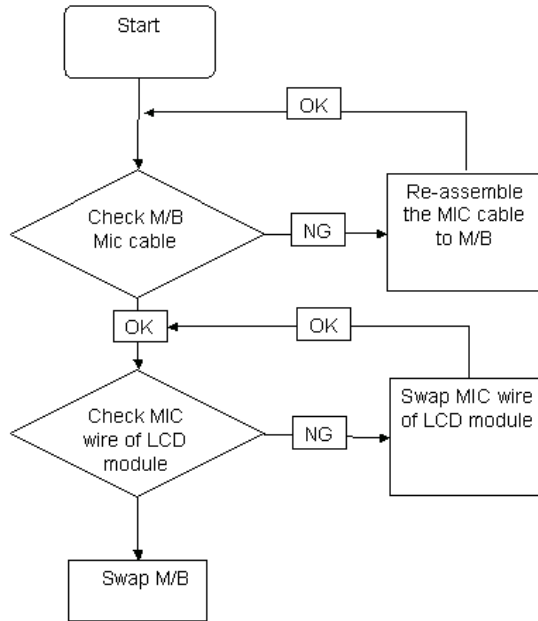

## Microphone Problems

If internal or external **Microphones** do not operate correctly, perform the following actions one at a time to correct the problem.

1. Check that the microphone is enabled. Navigate to **Start** → **Control Panel** → **Hardware and Sound** → **Sound** and select the **Recording** tab.
2. Right-click on the **Recording** tab and select **Show Disabled Devices** (clear by default).
3. The microphone appears on the **Recording** tab.
4. Right-click on the microphone and select **Enable**.
5. Select the microphone then click **Properties**. Select the **Levels** tab.
6. Increase the volume to the maximum setting and click **OK**.
7. Test the microphone hardware:
  - a. Select the microphone and click **Configure**.
  - b. Select **Set up microphone**.
  - c. Select the microphone type from the list and click **Next**.
  - d. Follow the onscreen prompts to complete the test.
8. If the Issue is still not resolved, see “Online Support Information” on page 197.



---

## HDD Not Operating Correctly

If the **HDD** does not operate correctly, perform the following actions one at a time to correct the problem.

1. Disconnect all external devices.
2. Run a complete virus scan using up-to-date software to ensure the computer is virus free.
3. Run the Windows Vista Startup Repair Utility:
  - a. insert the Windows Vista Operating System DVD in the ODD and restart the computer.
  - b. When prompted, press any key to start to the operating system DVD.
  - c. The **Install Windows** screen displays. Click **Next**.
  - d. Select **Repair your computer**.
  - e. The **System Recovery Options** screen displays. Click **Next**.
  - f. Select the appropriate operating system, and click **Next**.

**NOTE:** Click **Load Drivers** if controller drives are required.

- g. Select **Startup Repair**.
- h. Startup Repair attempts to locate and resolve issues with the computer.
- i. When complete, click **Finish**.

If an issue is discovered, follow the onscreen information to resolve the problem.

4. Run the Windows Memory Diagnostic Tool. For more information see Windows Help and Support.
5. Restart the computer and press F2 to enter the BIOS Utility. Check the BIOS settings are correct and that CD/DVD drive is set as the first boot device on the Boot menu.
6. Ensure all cables and jumpers on the HDD and ODD are set correctly.
7. Remove any recently added hardware and associated software.
8. Run the Windows Disk Defragmenter. For more information see Windows Help and Support.
9. Run Windows Check Disk by entering **chkdsk /r** from a command prompt. For more information see Windows Help and Support.
10. Restore system and file settings from a known good date using **System Restore**.

If the issue is not fixed, repeat the preceding steps and select an earlier time and date.
11. Replace the HDD. See "Disassembly Process" on page 44.

---

## ODD Failure

If the **ODD** fails, perform the following actions one at a time to correct the problem. Do not replace a non-defective FRUs:

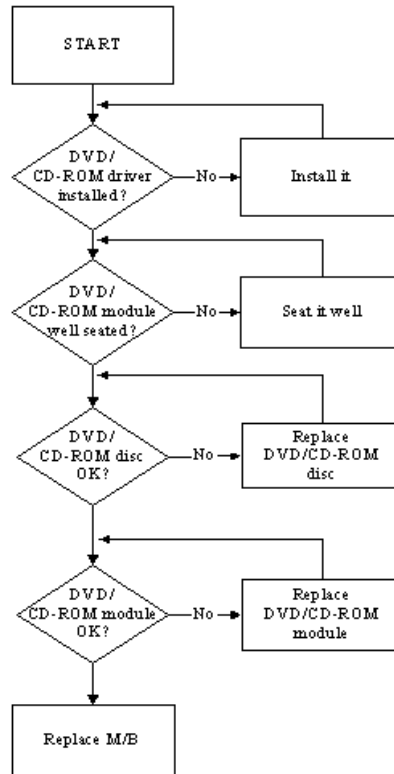

## ODD Not Operating Correctly

If the **ODD** exhibits any of the following symptoms it may be faulty:

- Audio CDs do not play when loaded
- DVDs do not play when loaded
- Blank discs do not burn correctly
- DVD or CD play breaks up or jumps
- Optical drive not found or not active:
  - Not shown in My Computer or the BIOS setup
  - LED does not flash when the computer starts up
  - The tray does not eject
- Access failure screen displays
- The ODD is noisy

Perform the following general solutions one at a time to correct the problem.

1. Reboot the computer and retry the operation.
2. Try an alternate disc.
3. Navigate to **Start** → **Computer**. Check that the ODD device is displayed in the **Devices with Removable Storage** panel.
4. Navigate to **Start** → **Control Panel** → **System and Maintenance** → **System** → **Device Manager**.

- 
- a. Double-click **IDE ATA/ATAPI controllers**. If a device displays a down arrow, right-click on the device and click **Enable**.
  - b. Double-click **DVD/CD-ROM drives**. If the device displays a down arrow, right-click on the device and click **Enable**.
  - c. Check that there are no yellow exclamation marks against the items in **IDE ATA/ATAPI controllers**. If a device has an exclamation mark, right-click on the device and uninstall and reinstall the driver.
  - d. Check that there are no yellow exclamation marks against the items in **DVD/CD-ROM drives**. If a device has an exclamation mark, right-click on the device and uninstall and reinstall the driver.
  - e. If the exclamation marker is not removed from the item in the lists, try removing any recently installed software and retrying the operation.

## Discs Do Not Play

If discs do not play when inserted in the drive, perform the following actions one at a time to correct the problem.

1. Check that the disc is correctly seated in the drive tray and that the label on the disc is visible.
2. Check that the media is clean and scratch free.
3. Try an alternate disc in the drive.
4. Ensure that **AutoPlay** is enabled:
  - a. Navigate to **Start** → **Control Panel** → **Hardware and Sound** → **AutoPlay**.
  - b. Select **Use AutoPlay for all media and devices**.
  - c. In the Audio CD and DVD Movie fields, select the desired player from the drop down menu.
5. Check that the Regional Code is correct for the selected media:

**IMPORTANT:**Region can only be changed a limited number of times. After Changes remaining reaches zero, the region cannot be changed even Windows is reinstalled or the drive is moved to another computer.

- a. Navigate to **Start** → **Control Panel** → **System and Maintenance** → **System** → **Device Manager**.
- b. Double-click **DVD/CD-ROM drives**.
- c. Right-click **DVD drive** and click **Properties**, then click the **DVD Region** tab.
- d. Select the region suitable for the media inserted in the drive.

## Discs Do Not Burn Properly

If discs can not be burned, perform the following actions one at a time to correct the problem.

1. Ensure that the default drive is record enabled:
  - a. Navigate to **Start** → **Computer** and right-click the writable ODD icon. Click **Properties**.
  - b. Select the **Recording** tab. In the **Desktop disc recording** panel, select the writable ODD from the drop down list.
  - c. Click **OK**.
2. Ensure that the software used for burning discs is the factory default. If using different software, refer to the software's user manual.

## Playback is Choppy

If playback is choppy or jumps, perform the following actions one at a time to correct the problem.

1. Check that system resources are not running low:
  - a. Try closing some applications.
  - b. Reboot and try the operation again.
2. Check that the ODD controller transfer mode is set to DMA:
  - a. Navigate to **Start** → **Control Panel** → **System and Maintenance** → **System** → **Device Manager**.

- 
- b. Double-click **IDE ATA/ATAPI controllers**, then right-click ATA Device 0.
  - c. Click **Properties** and select the **Advanced Settings** tab. Ensure that the **Enable DMA** box is checked and click **OK**.
  - d. Repeat for the other ATA Devices shown if applicable.

### Drive Not Detected

If Windows cannot detect the drive, perform the following actions one at a time to correct the problem.

1. Restart the computer and press F2 to enter the BIOS Utility.
2. Check that the drive is detected in the **ATAPI Model Name** field on the Information page.  
**NOTE:** Check that the entry is identical to one of the ODDs specified in “Hardware Specifications and Configurations” on page 18.
3. Turn off the power and remove the cover to inspect the connections to the ODD. See “Disassembly Process” on page 44.
  - a. Check for broken connectors on the drive, motherboard, and cables.
  - b. Check for bent or broken pins on the drive, motherboard, and cable connections.
  - c. Try an alternate cable, if available. If the drive works with the new cable, the original cable should be replaced.
4. Reseat the drive ensuring and all cables are connected correctly.
5. Replace the ODD. See “Disassembly Process” on page 44.

### Drive Read Failure

If discs cannot be read when inserted in the drive, perform the following actions one at a time to correct the problem.

1. Remove and clean the failed disc.
2. Retry reading the CD or DVD.
  - d. Test the drive using other discs.
  - e. Play a DVD movie
  - f. Listen to a music CD

If the ODD works properly with alternate discs, the original disc is probably defective and should be replaced.

3. Turn off the power and remove the cover to inspect the connections to the ODD. See “Disassembly Process” on page 44.
  - a. Check for broken connectors on the drive, motherboard, and cables.
  - b. Check for bent or broken pins on the drive, motherboard, and cable connections.
  - c. Try an alternate cable, if available. If the drive works with the new cable, the original cable should be replaced.
4. Replace the ODD. See “Disassembly Process” on page 44.

## USB Failure (Rightside)

If the rightside **USB** port fails, perform the following actions one at a time to correct the problem. Do not replace a non-defective FRUs:

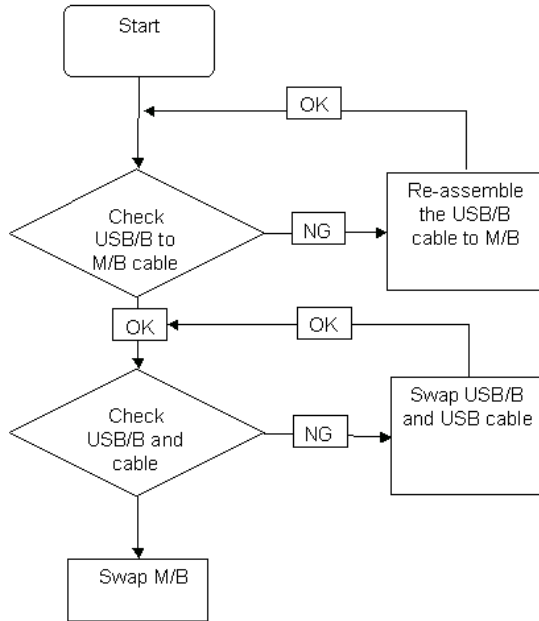

## Modem Function Failure

If the internal **Modem** fails, perform the following actions one at a time to correct the problem. Do not replace a non-defective FRUs:

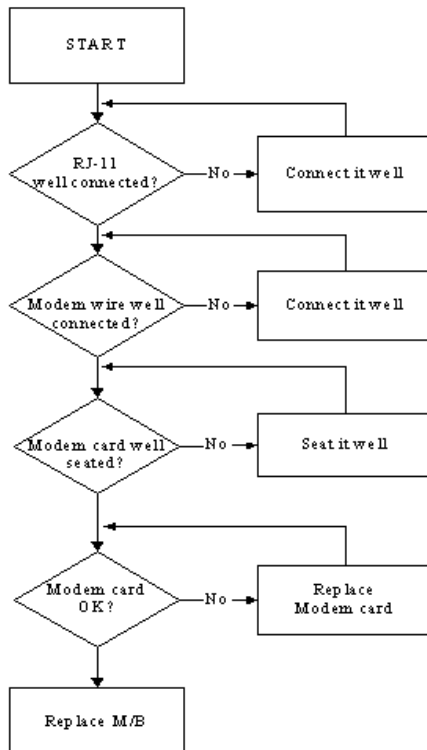

# Wireless Function Failure

If the **WLAN** fails, perform the following actions one at a time to correct the problem. Do not replace a non-defective FRUs:

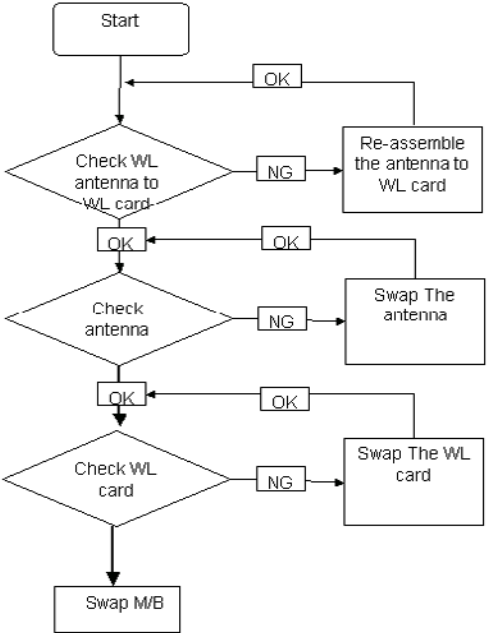

# EasyTouch Button Failure

If the **Acer EasyTouch** buttons fail, perform the following actions one at a time to correct the problem. Do not replace a non-defective FRUs:

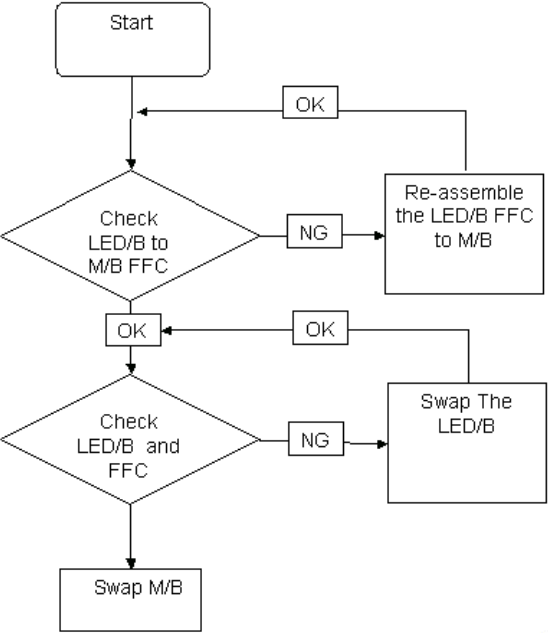

---

## MediaTouch Button Failure

If the **Acer MediaTouch** buttons fail, perform the following actions one at a time to correct the problem. Do not replace a non-defective FRUs:

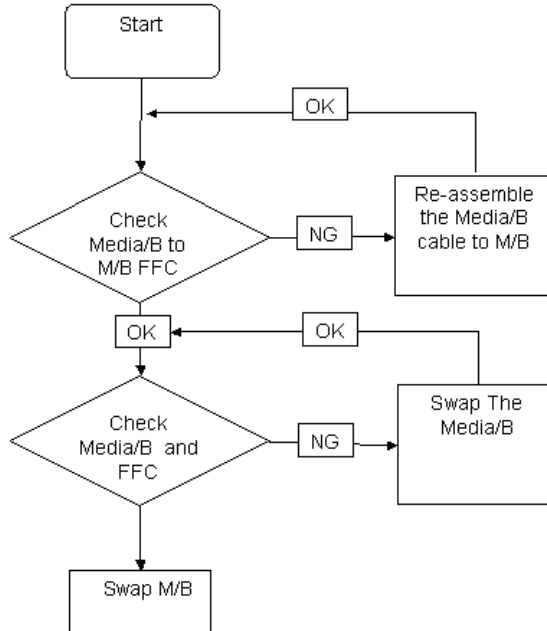

## Fingerprint Reader Failure

If the **Fingerprint Reader** fails, perform the following actions one at a time to correct the problem. Do not replace a non-defective FRUs:

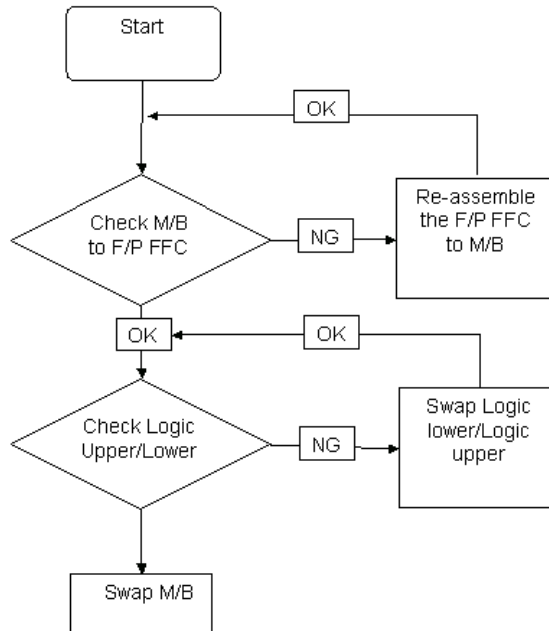

# Thermal Unit Failure

If the **Thermal Unit** fails, perform the following actions one at a time to correct the problem. Do not replace a non-defective FRUs:

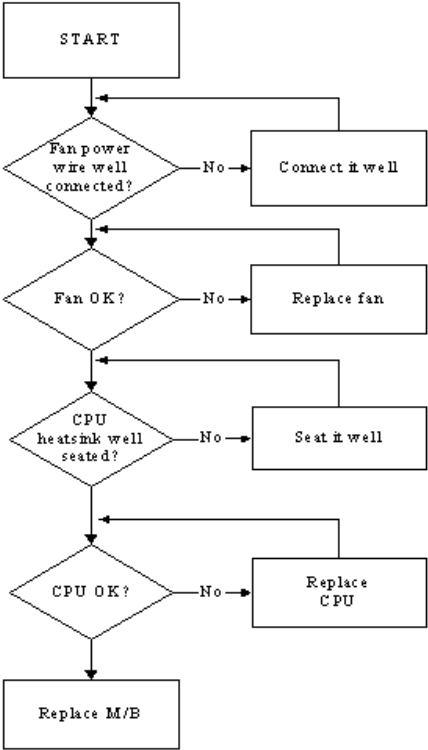

# HDTV Switch Failure

If the **HDTV Switch** fails, perform the following actions one at a time to correct the problem. Do not replace a non-defective FRUs:

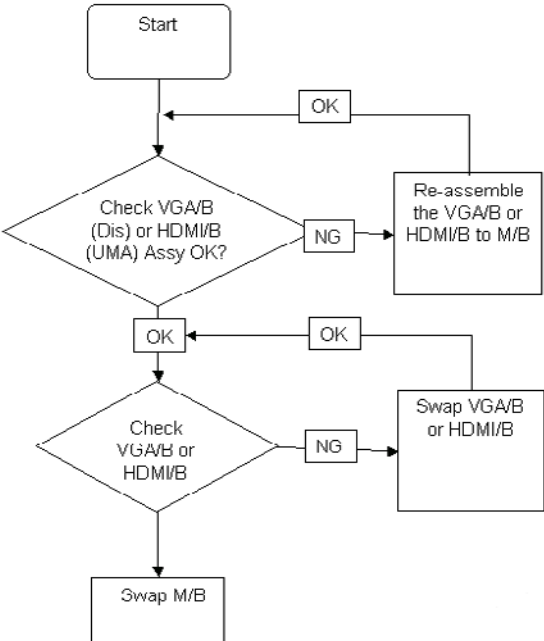



---

## External Mouse Failure

If an external **Mouse** fails, perform the following actions one at a time to correct the problem.

1. Try an alternative mouse.
2. If the mouse uses a wireless connection, insert new batteries and confirm there is a good connection. See the mouse user manual.
3. If the mouse uses a USB connection, try an alternate USB port.
4. Try an alternative program to verify mouse operation. Reinstall the program experiencing mouse failure.
5. Restart the computer.
6. Remove any recently added hardware and associated software.
7. Remove any recently added software and reboot.
8. Restore system and file settings from a known good date using **System Restore**.

If the issue is not fixed, repeat the preceding steps and select an earlier time and date.

9. Run the Event Viewer to check the events log for errors. For more information see Windows Help and Support.
10. Roll back the mouse driver to the previous version if updated recently.
11. Remove and reinstall the mouse driver.
12. Check the Device Manager to determine that:
  - The device is properly installed. There are no red Xs or yellow exclamation marks.
  - There are no device conflicts.
  - No hardware is listed under Other Devices.
13. If the Issue is still not resolved, see "Online Support Information" on page 197.

## Other Failures

If the CRT Switch, Dock, LAN Port, external MIC or Speakers, PCI Express Card, 5-in-1 Card Reader or Volume Wheel fail, perform the following general steps to correct the problem. Do not replace a non-defective FRUs:

1. Check Drive whether is OK.
2. Check Test Fixture is ok.
3. Swap M/B to Try.

---

## Intermittent Problems

Intermittent system hang problems can be caused by a variety of reasons that have nothing to do with a hardware defect, such as: cosmic radiation, electrostatic discharge, or software errors. FRU replacement should be considered only when a recurring problem exists.

When analyzing an intermittent problem, do the following:

1. Run the advanced diagnostic test for the system board in loop mode at least 10 times.
2. If no error is detected, do not replace any FRU.
3. If any error is detected, replace the FRU. Rerun the test to verify that there are no more errors.

## Undetermined Problems

The diagnostic problems does not identify which adapter or device failed, which installed devices are incorrect, whether a short circuit is suspected, or whether the system is inoperative.

Follow these procedures to isolate the failing FRU (do not isolate non-defective FRU).

**NOTE:** Verify that all attached devices are supported by the computer.

**NOTE:** Verify that the power supply being used at the time of the failure is operating correctly. (See “Power On Issue” on page 128.):

1. Power-off the computer.
2. Visually check them for damage. If any problems are found, replace the FRU.
3. Remove or disconnect all of the following devices:
  - Non-Acer devices
  - Printer, mouse, and other external devices
  - Battery pack
  - Hard disk drive
  - DIMM
  - CD-ROM/Diskette drive Module
  - PC Cards
4. Power-on the computer.
5. Determine if the problem has changed.
6. If the problem does not recur, reconnect the removed devices one at a time until you find the failing FRU.
7. If the problem remains, replace the following FRU one at a time. Do not replace a non-defective FRU:
  - System board
  - LCD assembly

# POST Codes Tables

These tables describe the chipset and core POST codes, functions, phases, and components for the POST.

## Chipset POST Codes

The following table details the chipset POST codes and functions used in the POST.

POST Code	Function	Phase	Component
0xA0	MRC Entry	PEI	chipset/MRC
0x01	Enable MCHBAR	PEI	chipset/MRC
0x02	Check ME existence	PEI	chipset/MRC
0x03	Check for DRAM initialization interrupt and reset fail	PEI	chipset/MRC
0x04	Determine the system Memory type based on first populated socket	PEI	chipset/MRC
0x05	Verify all DIMMs are DDR2 and SO-DIMMS, which are unbuffered	PEI	chipset/MRC
0x06	Verify all DIMMs are Non-ECC	PEI	chipset/MRC
0x07	Verify all DIMMs are single or double sided and not mixed	PEI	chipset/MRC
0x08	Verify all DIMMs are x8 or x16 width	PEI	chipset/MRC
0x09	Calculate number of Row and Column bits	PEI	chipset/MRC
0x10	Calculate number of banks for each DIMM	PEI	chipset/MRC
0x11	Determine raw card type	PEI	chipset/MRC
0x12	Find a common CAS latency between the DIMMS and the MCH	PEI	chipset/MRC
0x13	Determine the memory frequency and CAS latency to program	PEI	chipset/MRC
0x14	Determine the smallest common timing value for all DIMMS	PEI	chipset/MRC
0x17	Power management resume	PEI	chipset/MRC
0x18	Program DRAM type (DDR2/DDR3) and Power up sequence	PEI	chipset/MRC
0x19	Program the correct system memory frequency	PEI	chipset/MRC
0x20	Program the correct Graphics memory frequency	PEI	chipset/MRC
0x21	Early DRC initialization	PEI	chipset/MRC
0x22	Program the DRAM Row Attributes and DRAM Row Boundary registers PRE JEDEC.	PEI	chipset/MRC
0x23	Program the RCOMP SRAM registers	PEI	chipset/MRC
0x24	Program DRAM type (DDR2/DDR3) and Power up sequence	PEI	chipset/MRC
0x25	Program the DRAM Timing	PEI	chipset/MRC
0x26	Program the DRAM Bank Architecture register	PEI	chipset/MRC
0x27	Enable all clocks on populated rows	PEI	chipset/MRC
0x28	Program MCH ODT	PEI	chipset/MRC
0x29	Program tRD	PEI	chipset/MRC
0x30	Miscellaneous Pre JEDEC steps	PEI	chipset/MRC
0x31	Program clock crossing registers	PEI	chipset/MRC

POST Code	Function	Phase	Component
0x32	Program the Egress port timings	PEI	chipset/MRC
0x33	Program the Memory IO registers	PEI	chipset/MRC
0x34	Perform steps required before JEDEC	PEI	chipset/MRC
0x35	Perform JEDEC memory initialization for all memory rows	PEI	chipset/MRC
0x36	Setup DRAM control register for normal operation and enable	PEI	chipset/MRC
0x37	Do ZQ calibration for DDR3	PEI	chipset/MRC
0x38	Perform final Dra/Drb programming, Set the mode of operation for the memory channels	PEI	chipset/MRC
0x39	Set Enhanced addressing mode for each channel	PEI	chipset/MRC
0x40	Perform steps required after JEDEC init	PEI	chipset/MRC
0x41	Program the receive enable reference timing control register	PEI	chipset/MRC
0x42	Post receive enable initialization	PEI	chipset/MRC
0x43	Enable sense amps. Reset read/write DQS pointers	PEI	chipset/MRC
0x44	Perform ME steps	PEI	chipset/MRC
0x45	Clear DRAM initialization bit in the ICH.	PEI	chipset/MRC
0x46	Program Thermal Management	PEI	chipset/MRC
0x47	Program TS on DIMM	PEI	chipset/MRC
0x48	Program TS on Board	PEI	chipset/MRC
0xAF	Exit MRC	PEI	chipset/MRC
0xE0	#define MEM_ERR_BAD_DIMM (S11)	PEI	chipset/MRC
0xE1	#define MEM_ERR_ECC_DIMM (S06)	PEI	chipset/MRC
0xE2	#define MEM_ERR_SIDES (S07)	PEI	chipset/MRC
0xE3	#define MEM_ERR_WIDTH (S08, S10)	PEI	chipset/MRC
0xE4	#define MEM_ERR_TRFC (FindTrasTrpTrcd)	PEI	chipset/MRC
0xE5	#define MEM_ERR_CAS_LATENCY (S12, S13)	PEI	chipset/MRC
0xE6	#define MEM_ERR_REFRESH (ProgDrt)	PEI	chipset/MRC
0xE7	#define MEM_ERR_BL8 (S14)	PEI	chipset/MRC
0xE9	#define MEM_ERR_FREQUENCY (findTCLTacTCIk, S13, S12, ProgramGraphicsFrequency, ProgMchOdt, GetPlatformData)	PEI	chipset/MRC
0xEA	#define MEM_ERR_SIZE (S14)	PEI	chipset/MRC
0xEC	#define MEM_ERR_TRAS (FindTrasTrpTrcd)	PEI	chipset/MRC
0xED	#define MEM_ERR_TRP (FindTrasTrpTrcd)	PEI	chipset/MRC
0xEE	#define MEM_ERR_TRCD (FindTrasTrpTrcd)	PEI	chipset/MRC
0xEF	#define MEM_ERR_TWR (FindTrasTrpTrcd)	PEI	chipset/MRC
0xF0	#define MEM_ERR_RCVEN_FINDLOW (CalibrateRcvenForGroup)	PEI	chipset/MRC
0xF1	#define MEM_ERR_RCVEN_FINDEDGE (CalibrateRcvenForGroup)	PEI	chipset/MRC
0xF2	#define MEM_ERR_RCVEN_FINDPREAMBLE (CalibrateRcvenForGroup)	PEI	chipset/MRC
0xF6	#define MEM_ERR_RCVEN_PREAMBLEEDGE (CalibrateRcvenForGroup)	PEI	chipset/MRC

POST Code	Function	Phase	Component
0xF3	#define MEM_ERR_RCVEN_FINDCENTER (CalibrateRcvenForGroup)	PEI	chipset/MRC
0xFZ	#define MEM_ERR_TYPE (S11, S04)	PEI	chipset/MRC
0xF5	#define MEM_ERR_RAWCARD (S11)	PEI	chipset/MRC
0xFA	#define MEM_ERR_SFF (ProgWrioDll)	PEI	chipset/MRC
0xFB	#define MEM_ERR_THERMAL (ProgramThrottling)	PEI	chipset/MRC
0xA0xx	Launch BIOS ACMSclean	PEI	chipset/TXT
0xA4xx	Launch BIOS ACMScheck	PEI	chipset/TXT
0xE5	Wait for ME ready	DXE	HECI/iAMT
0xE6	ME Ready	DXE	HECI/iAMT

## Core POST Codes

The following table details the core POST codes and functions used in the POST.

POST Code	Function	Phase	Component
0x00	Early Microcode update for CAR	CEI / SEC	Core
0x01	Enable CAR	CEI / SEC	Core
0x02	CAR Done, initial stack	CEI / SEC	Core
0xEE	unknown CPU ID to load uCode	CEI / SEC	CPU
0xEF	unknown DT CPU to load uCode	CEI / SEC	CPU
0xnn	File count found in a volume	PEI	Core
0x11	Debug Test driver for debug test PPI 1 (If install debugTest driver)	PEI	Core
0x22	Debug Test driver for debug test PPI 2 (If install debugTest driver)	PEI	Core
0x33	Debug Test driver for debug test PPI 3 (If install debugTest driver)	PEI	Core
0x44	Entry point of loadfile	PEI	Core
0x88	Entry point of apMuLoader	PEI	Core
0x80	A PEIM found	PEI	Core
0x82	PEIM not dispatched yet	PEI	Core
0x84	PEIM satisfies depex	PEI	Core
0x86	Image loaded but fail on security	PEI	Core
0x88	Executing a PEIM	PEI	Core
0x8A	Processing notify event for newly installed PPI	PEI	Core
0x8C	Handing off to next phase (DXE)	PEI	Core
0x8F	Fail to hand off to next phase, system halt	PEI	Core
0x90	All PEIM dispatched! Going to DxeIpl	PEI	Core
0xCC	AP Micro-code update	PEI	Core
0x20	S3 resume entry	S3 resume	Core
0x21	Start running Boot-time bootscripts	S3 resume	Core
0x22	Start running Run-time bootscripts	S3 resume	Core
0x23	End of S3 resume, jump back to Waking vector	S3 resume	Core
0x80	Initialize the chipset	Crisis Recovery	Core
0x81	Initialize the bridge	Crisis Recovery	Core

POST Code	Function	Phase	Component
0x82	Initialize the CPU	Crisis Recovery	Core
0x89	Set Huge Segment	Crisis Recovery	Core
0x83	Initialize system timer	Crisis Recovery	Core
0x84	Initialize system I/O	Crisis Recovery	Core
0x88	Initialize Multi Processor	Crisis Recovery	Core
0x8A	Initialize OEM special code	Crisis Recovery	Core
0x8B	Initialize PIC and DMA	Crisis Recovery	Core
0x8C	Initialize Memory type	Crisis Recovery	Core
0x8D	Initialize Memory size	Crisis Recovery	Core
0x8F	Initialize SMM	Crisis Recovery	Core
0x90	System memory test	Crisis Recovery	Core
0x91	Initialize interrupt vectors	Crisis Recovery	Core
0x92	Initialize Run Time Clock	Crisis Recovery	Core
0x99	Initialize security	Crisis Recovery	Core
0x93	Initialize video	Crisis Recovery	Core
0x94	Output one beep	Crisis Recovery	Core
0x98	USB Initialization	Crisis Recovery	Core
0x95	Initialize the installed boot devices	Crisis Recovery	Core
0x96	Clear Huge segment	Crisis Recovery	Core
0x97	Boot Crisis Disk	Crisis Recovery	Core
0x20	DXE starts	DXE	Core
0x30	BIOSPSM	DXE	Core
0x02	BIOSBlockIO	DXE	Core
0x00	BIOSPSM Exception Handler - Divide error	BIOSPSM	Core
0x38	Cannot locate LegacyRegion DXE	BIOSPSM	Core
0xB1	ACPISupport driver Installed	DXE	Core
0xE0	BDS Entry	DXE	Core
0x07	IA32 variable driver entry	DXE	Core
0x0D	conspliter driver entry	DXE	Core
0x10	partition driver entry	DXE	Core
0x49	pciRootBridge driver entry	DXE	Core
0xC6	pciBusDriver entry	DXE	Core
0xE0	Go to legacy BIOS or BDS Entry Point	DXE	Core
0x90	Start Image	DXE	Core
0x90	Start Image Successfully	DXE	Core
0x90	Start Image Failed	DXE	Core
0x33	Debug Test driver for debug test PPI 1	DXE	Core
0x22	Debug Test driver for debug test PPI 2	DXE	Core
0x11	Debug Test driver for debug test PPI 3	DXE	Core
0x02	Invalid event # for measuring Separator Event	DXE	TCG
0x02	Invalid event # for measuring Separator Event	DXE	TCG
0x02	PCR Index over limit (PCR > 23)	DXE	TCG
0x02	TCG copy memory failed	DXE	TCG

POST Code	Function	Phase	Component
0x09	TCG log event failed	DXE	TCG
0x09	Setup event log failed	DXE	TCG
0x12	TIS set active locality failed	DXE	TCG
0x12	TIS relinquish active locality failed	DXE	TCG
0x12	TIS wait command ready failed (prepare to send)	DXE	TCG
0x12	TIS abort 'send 'command due to timeout	DXE	TCG
0x12	TIS abort 'sendAndGo 'command due to timeout	DXE	TCG
0x04	TIS wait bit set failed before send last byte	DXE	TCG
0x12	TIS abort command due to timeout before send last byte	DXE	TCG
0x04	TIS wait bit clear failed when sending last byte	DXE	TCG
0x22	TCG Physical Presence execution	DXE	TCG
0xB1	TCG DXE common pass through	DXE	TCG
0xE3	First Legacy BIOS Task table for legacy reset	LBT	Core
0x20	Verify that DRAM refresh is operating by polling the refresh bit in PORTB.	LBT	Core
0xDA	Dummy PCIE Init entry, now handled by driver	LBT	Core
0x29	PMM (POST Memory Manager) init	LBT	Core
0xE5	WHEA init	LBT	Core
0x33	PDM (Post Dispatcher Manager) init	LBT	Core
0x01	IPMI init	LBT	Core
0xD8	ASF Init	LBT	Core
0x09	Set in-POST flag in CMOS that indicates we are in POST. If this bit is not cleared by postClearBootFlagJ (AEh), the TrustedCore on next boot determines that the current configuration caused POST to fail and uses default values for configuration.	LBT	Core
0x2B	Enhanced CMOS init	LBT	Core
0xE0	EFI Variable Init	LBT	Core
0xC1	PEM (Post Error Manager) init	LBT	Core
0x3B	Debug Service Init (ROM Polit)	LBT	Core
0xDC	POST Update Error	LBT	Core
0x3A	Autosize external cache and program cache size for enabling later in POST.	LBT	Core
0x0B	Enable CPU cache. Set bits in cmos related to cache.	LBT	Core
0x0F	Enable the local bus IDE as primary or secondary depending on other drives detected.	LBT	Core
0x10	Initialize Power Management.	LBT	Core
0x14	Verify that the 8742 keyboard controller is responding. Send a self-test command to the 8742 and wait for results. Also read the switch inputs from the 8742 and write the keyboard controller command byte.	LBT	Core

POST Code	Function	Phase	Component
0x1A	Initialize DMA command register with these settings: 1. Memory to memory disabled 2. Channel 0 hold address disabled 3. Controller enabled 4. Normal timing 5. Fixed priority 6. Late write selection 7. DREQ sense active 8. DACK sense active low.	LBT	Core
0x22	Reset the keyboard.	LBT	Core
0x40	Test A20 line	LBT	Core
0x67	Quick initialization of all Application Processors in a multi-processor system	LBT	Core
0x32	Compute CPU speed.	LBT	Core
0x69	Initialize the handler for SMM.	LBT	Core
0x6B	If CMOS is bad, load Custom Defaults from flash into CMOS. If successful, reboot.	LBT	Core
0x3C	If CMOS is valid, load chipset registers with values from CMOS, otherwise load defaults and display Setup prompt. If Auto Configuration is enabled, always load the chipset registers with the Setup defaults (Rel 6.0).	LBT	Core
0x3D	Load alternate registers with CMOS values	LBT	Core
0x42	Initialize interrupt vectors 0 thru 77h	LBT	Core
0x46	Verify the ROM copyright notice	LBT	Core
0x45	Initialize all motherboard devices.	LBT	Core
0x49	1. Size the PCI bus topology and set bridge bus numbers. 2. Set the system max bus number. 3. Write a 0 to the command register of every PCI device. 4. Write a 0 to all 6 base registers in every PCI device. 5. Write a -1 to the status register of every PC	LBT	Core
0xC6	Initialize note dock	LBT	Core
0xC5	PnPnd dual CMOS (optional)	LBT	Core
0x48	Verify that the equipment specified in the CMOS matches the hardware currently installed. If the monitor type is set to 00 then a video ROM must exist. If the monitor type is 1 or 2 set the video switch to CGA. If monitor type 3, set the video switch to m	LBT	Core
0xD1	Initialize BIOS stack	LBT	Core
0xD3	Setup E820h and WAD memory map	LBT	Core
0x24	Set segment-register addressability to 4 GB	LBT	Core
0xCC	Redirect Int 10h to enable target board to use a remote serial video (PICO BIOS).	LBT	Core
0x8A	Initialize Extended BIOS Data Area and initialize the mouse.	LBT	Core
0x9D	Initialize Security Engine.	LBT	Core
0x55	USB Initialization	LBT	Core
0x52	Verify keyboard reset.	LBT	Core
0x54	Initialize keystroke clicker if enabled in Setup.	LBT	Core
0x76	Check status bits for keyboard-related failures. Display error messages on the screen.	LBT	Core
0x4A	Initialize all video adapters in system	LBT	Core



POST Code	Function	Phase	Component
0x4C	Shadow video BIOS ROM if specified by Setup, and CMOS is valid and the previous boot was OK.	LBT	Core
0x59	Register POST Display Services, fonts, and languages with the POST Dispatch Manager.	LBT	Core
0x57	Initialize 1394 Firewire	LBT	Core
0xD6	Initialize PC card	LBT	Core
0x58	Test for unexpected interrupts. First do an STI for hot interrupts. Secondly, test the NMI for an unexpected interrupt. Thirdly, enable the parity checkers and read from memory, checking for an unexpected interrupt.	LBT	Core
0x3F	ROMPolit memory init	LBT	Core
0xC4	Install the IRQ vectors (Sever Hotkey)	LBT	Core
0x7C	Initialize the hardware interrupt vectors from 08 to 0F and from 70h to 77H. Also set the interrupt vectors from 60h to 66H to zero.	LBT	Core
0x41	ROM Pilot Init	LBT	Core
0x4B	Initialize QuietBoot if it is installed. Enable both keyboard and timer interrupts (IRQ0 and IRQ1). If your POST tasks require interrupts off, preserve them with a PUSHF and CLI at the beginning and a POPF at the end.	LBT	Core
0xDE	Initialize and UNDI ROM (fro remote flash)	LBT	Core
0xC6	Initial and install console for UCR	LBT	Core
0x4E	Display copyright notice.	LBT	Core
0xD4	Get CPU branding string	LBT	Core
0x50	Display CPU type and speed	LBT	Core
0xC9	pretask before EISA init	LBT	Core
0x51	EISA Init	LBT	Core
0x5A	Display prompt "Press F2 to enter SETUP"	LBT	Core
0x5B	Disable CPU cache.	LBT	Core
0x5C	Test RAM between 512K and 640K.	LBT	Core
0x60	Determine and test the amount of extended memory available. Determine if memory exists by writing to a few strategic locations and see if the data can be read back. If so, perform an address-line test and a RAM test on the memory.	LBT	Core
0x62	The amount of memory available. This test is dependent on the processor, since the test will vary depending on the width of memory (16 or 32 bits). This test will also use A20 as the skew address to prevent corruption of the system memory.	LBT	Core
0x64	Jump to UserPatch1.	LBT	Core
0x66	Set cache registers to their CMOS values if CMOS is valid, unless auto configuration is enabled, in which case load cache registers from the Setup default table.	LBT	Core
0x68	Enable external cache and CPU cache if present. Configure non-cacheable regions if necessary.	LBT	Core

POST Code	Function	Phase	Component
0x6A	Display external cache size on the screen if it is non-zero.	LBT	Core
0x6C	Display shadow message	LBT	Core
0xCA	post EISA init	LBT	Core
0x70	Check flags in CMOS and in the TrustedCore data area for errors detected during POST. Display error messages on the screen.	LBT	Core
0x72	Check status bits to see if configuration problems were detected. If so, display error messages on the screen.	LBT	Core
0x4F	Initialize MultiBoot. Allocate memory for old and new MultiBoot history tables.	LBT	Core
0xCD	Reclaim console vector after HW vectors initialized.	LBT	Core
0x7D	Initialize Intelligent System Monitoring.	LBT	Core
0x7E	The Coprocessor initialization test. Use the floating point instructions to determine if a coprocessor exists instead of the ET bit in CR0.	LBT	Core
0xC1	Check Boot Type (Server BIOS)	LBT	Core
0x80	Disable onboard COM and LPT ports before testing for presence of external I/O devices.	LBT	Core
0xCA	Redirect Int 15h to enable target board to use remote keyboard (PICO BIOS).	LBT	Core
0x88	Initialize interrupt controller.	LBT	Core
0x81	Run late device initialization routines.	LBT	Core
0x87	Initialize motherboard configurable devices.	LBT	Core
0x85	Display any ESCD read errors and configure all PnP ISA devices.	LBT	Core
0x82	Test and identify RS232 ports.	LBT	Core
0x84	Test and identify parallel ports.	LBT	Core
0x86	Initialize onboard I/O and BDA according to CMOS and presence of external devices.	LBT	Core
0x83	Configure Fisk Disk Controller.	LBT	Core
0xCE	Initialize digitizer device and display installed message if successful.	LBT	Core
0x89	Enable non-maskable interrupts.	LBT	Core
0x8C	Initialize both of the floppy disks and display an error message if failure was detected. Check both drives to establish the appropriate diskette types in the TrustedCore data area	LBT	Core
0xCB	Redirect Int 13h to Memory Technologies Devices such as ROM, RAM, PCMCIA, and serial disk (PICO BIOS).	LBT	Core
0xCD	Remap I/O and memory address space for PCMCIA (PICO BIOS).	LBT	Core
0x90	Initialize hard-disk controller. If the CMOS ram is valid and intact, and fixed disks are defined, call the fixed disk init routine to initialize the fixed disk system and take over the appropriate interrupt vectors.	LBT	Core

POST Code	Function	Phase	Component
0x8B	Setup interrupt vector and present bit in Equipment byte.	LBT	Core
0x95	1. Check CMOS for CD-ROM drive present 2. Activate the drive by checking for media present 3. Check sector 11h (17) for Boot Record Volume Descriptor 4. Check the boot catalog for validity 5. Pick a boot entry 6. Create a Specification Packet	LBT	Core
0x92	Jump to UserPatch2.	LBT	Core
0xB6	If password on boot is enabled, a call is made to Setup to check password. If the user does not enter a valid password, Setup does not return.	LBT	Core
0x98	Search for option ROMs. Rom scan the area from C800h for a length of BCP_ROM_Scan_Size (or to E000h by default) on every 2K boundary, looking for add on cards that need initialization.	LBT	Core
0x93	Build the MPTABLE for multi-processor boards	LBT	Core
0xD9	IPMI late init	LBT	Core
0x9C	Set up Power Management. Initiate power - management state machine.	LBT	Core
0xC7	Late note dock init	LBT	Core
0x9E	Enable hardware interrupts	LBT	Core
0xA0	Setup time tick for current date/time	LBT	Core
0xA2	Setup Numlock indicator. Display a message if key switch is locked.	LBT	Core
0xA4	Initialize typematic rate	LBT	Core
0xDB	StrongROM Test	LBT	Core
0xE2	OEM security key test	LBT	Core
0xC2	Write PEM errors.	LBT	Core
0xBA	Initialize the SMBIOS header and sub-structures.	LBT	Core
0xC3	Display PEM errors.	LBT	Core
0xA8	Overwrite the "Press F2 for Setup" prompt with spaces, erasing it from the screen.	LBT	Core
0xAA	Scan the key buffer to see if the F2 key was struck after keyboard interrupts were enabled. If an F2 keystroke is found, set a flag.	LBT	Core
0xE1	Start Periodic Timer (TC Subscribe)	LBT	Core
0xAC	Check if "Enter SETUP" is pressed.	LBT	Core
0x8F	Count the number of ATA drives in the system and update the number in bdaFdiskcount.	LBT	Core
0x91	Configure the local bus IDE timing register based on the drives attached to it.	LBT	Core
0x9F	Check the total number of Fast Disks (ATA and SCSI) and update the bdaFdiskCount.	LBT	Core
0xD7	Check if FirstWare HPA exists	LBT	Core
0xAE	Clear ConfigFailedBit and InPostBit in CMOS.	LBT	Core
0xB0	Check for errors and decide if needs to run Setup.	LBT	Core
0xB2	Change status bits in CMOS and/or the TrustedCore data area to reflect the fact that POST is complete.	LBT	Core

POST Code	Function	Phase	Component
0xB5	Fade out OEM Logo or post string	LBT	Core
0xC5	End hotkey detection (Server BIOS)	LBT	Core
0xBE	If BCP option is enabled, clear the screen before booting.	LBT	Core
0xB6	If password on boot is enabled, a call is made to Setup to check password. If the user does not enter a valid password, Setup does not return.	LBT	Core
0xBC	Clear parity-error latch	LBT	Core
0xB7	Initialize ACPI BIOS.	LBT	Core
0x9B	Enable CPU management (Geyserville I)	LBT	Core
0xBD	Display Boot First menu if MultiBoot is installed and hotkey pressed.	LBT	Core
0xBF	Check virus and backup reminders.	LBT	Core
0x97	Create pointer to MP table in Extended BDA.	LBT	Core
0x99	Check support status for Self-Monitoring Analysis Reporting Technology (disk-failure warning).	LBT	Core
0xB1	Unload ROM Pilot	LBT	Core
0xDD	Perform remote flash if requested	LBT	Core
0xC7	If UCR redirection is installed, remove display manager and unhook INT10	LBT	Core
0XDF	Shutdown the PXE UNDI code	LBT	Core
0xB3	Store enhanced CMOS values in non-volatile area	LBT	Core
0xE4	Last Legacy BIOS Task before hand off to UEFI/DXE	LBT	Core
0xB9	Clear all screen graphics before booting.	bootLegacy	Core
0xC0	INT19 entry for legacy boot	bootLegacy	Core
0xEF	Invalid AP #	SDXE	Core
0xEF	Non-Yohna and non-Morem class CPU found for SDXE (getTSCFreq)	SDXE	Core
0xEE	AP cannot synch BSP in SDXE (syncWithBSP)	SDXE	Core
0xEE	BSP cannot synch w/ AP in SDXE (syncWithAP)	SDXE	Core

# Jumper and Connector Locations

## Top View

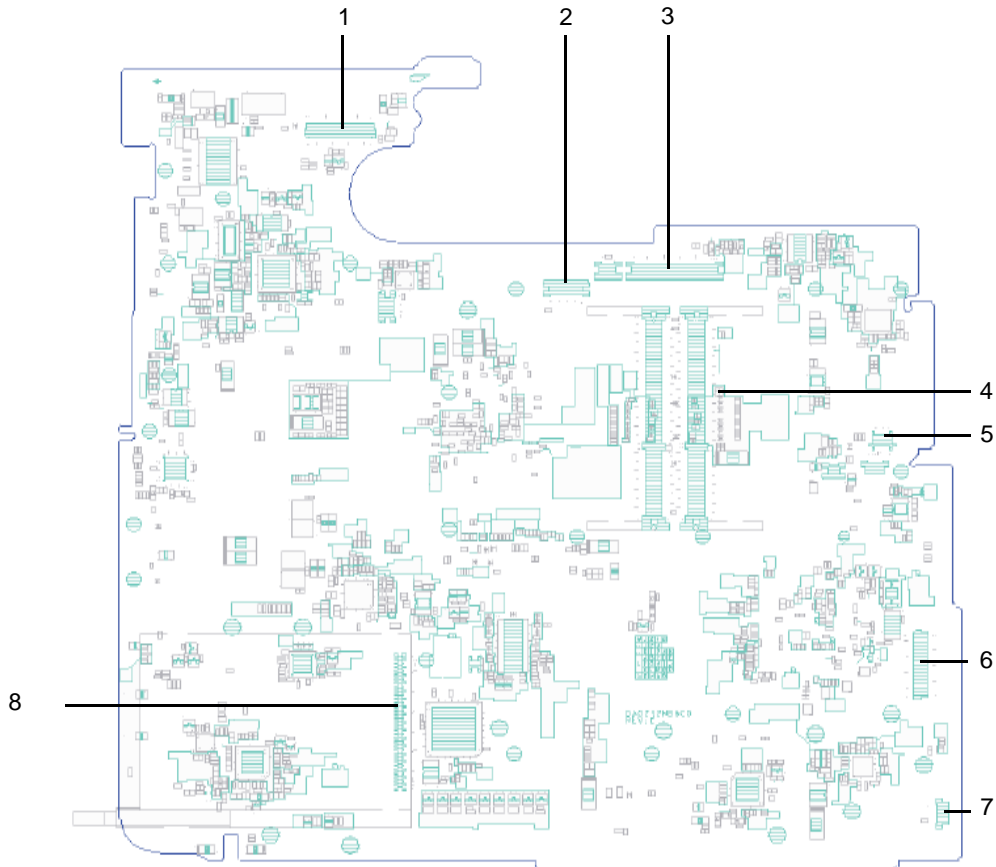

No.	Description	No.	Description
1	LCD Connector	5	MDC Connector
2	Powerboard Connector	6	ExpressCard Board Connector
3	Keyboard Connector	7	BLuetooth Connector
4	DDR3 Connector	8	PCMCIA Connector

# Bottom View

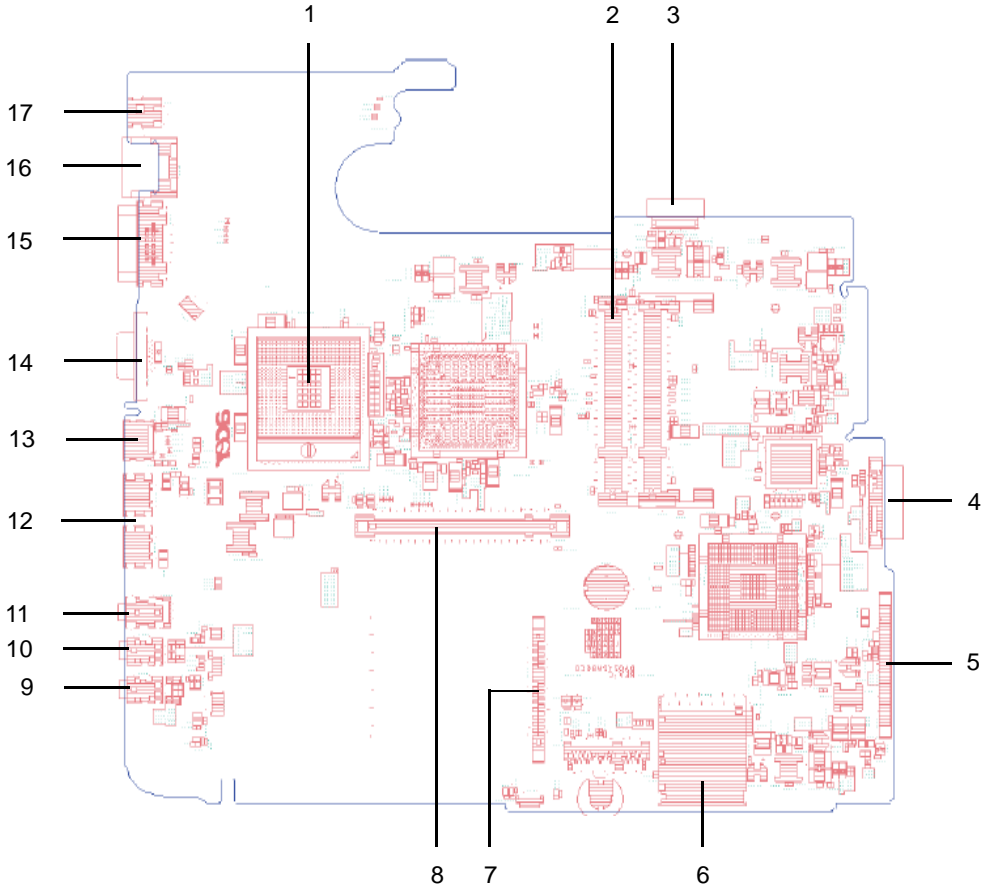

No.	Description	No.	Description
1	CPU Socket	10	Audio Connector
2	DDR2 Connector	11	SPDIF Connector
3	Battery Connector	12	USB Connector
4	ODD Connector	13	HDMI Connector
5	HDD Connector	14	CRT Connector
6	Card Reader Connector	15	Docking Connector
7	HDD Connector	16	RJ 45
8	MXM Connector	17	DC Jack
9	Audio Connector		

---

# Clearing Password Check and BIOS Recovery

This section provide you the standard operating procedures of clearing password and BIOS recovery for Aspire 7730/7730G. Aspire 7730/7730G provide one Hardware Open Gap on main board for clearing password check, and one Hotkey for enabling BIOS Recovery.

## Clearing Password Check

### Hardware Open Gap Description

Item	Description
R347 (RTC_RST)	Clear CMOS Jumper



### Steps for Clearing BIOS Password Check

If users set BIOS Password (Supervisor Password and/or User Password) for a security reason, BIOS will ask the password during systems POST or when systems enter to BIOS Setup menu. However, once it is necessary to bypass the password check, users need to short the HW Gap to clear the password by the following steps:

- Power Off a system, and remove HDD, AC and Battery from the machine.
- Open the back cover of the machine, and find out the HW Gap on M/B as picture.
- Use an electric conductivity tool to short the two points of the HW Gap.
- Plug in AC, keep the short condition on the HW Gap, and press Power Button to power on the system till BIOS POST finish. Then remove the tool from the HW Gap.
- Restart system. Press F2 key to enter BIOS Setup menu.
- If there is no Password request, BIOS Password is cleared. Otherwise, please follow the steps and try again.

**NOTE:** The steps are only for clearing BIOS Password (Supervisor Password and User Password).

---

## BIOS Recovery by Crisis Disk

### BIOS Recovery Boot Block:

BIOS Recovery Boot Block is a special block of BIOS. It is used to boot up the system with minimum BIOS initialization. Users can enable this feature to restore the BIOS firmware to a successful one once the previous BIOS flashing process failed.

### BIOS Recovery Hotkey:

The system provides a function hotkey: **Fn+Esc**, for enable BIOS Recovery process when system is powered on during BIOS POST. To use this function, it is strongly recommended to have the AC adapter and Battery present. If this function is enabled, the system will force the BIOS to enter a special BIOS block, called Boot Block.

### Steps for BIOS Recovery from USB Storage:

Before doing this, prepare the Crisis USB key. The Crisis USB key could be made by executing the Crisis Disk program in another system with Windows XP OS.

Follow the steps below:

1. Save ROM file (file name: **JAL90x64.fd**) to the root directory of USB storage.
2. Plug USB storage into USB port.
3. Press **Fn + ESC** button then plug in AC.  
The Power button flashes once.
4. Press **Power** button to initiate system CRISIS mode.  
When CRISIS is complete, the system auto restarts with a workable BIOS.
5. Update the latest version BIOS for this machine by regular BIOS flashing process.



## FRU (Field Replaceable Unit) List

---

This chapter gives you the FRU (Field Replaceable Unit) listing in global configurations of Aspire 7730/7730G. Refer to this chapter whenever ordering for parts to repair or for RMA (Return Merchandise Authorization).

Please note that WHEN ORDERING FRU PARTS, you should check the most up-to-date information available on your regional web or channel. For whatever reasons a part number change is made, it will not be noted on the printed Service Guide. For ACER AUTHORIZED SERVICE PROVIDERS, your Acer office may have a DIFFERENT part number code from those given in the FRU list of this printed Service Guide. You MUST use the local FRU list provided by your regional Acer office to order FRU parts for repair and service of customer machines.

NOTE: To scrap or to return the defective parts, you should follow the local government ordinance or regulations on how to dispose it properly, or follow the rules set by your regional Acer office on how to return it.

---

# Aspire 7730/7730G Exploded Diagrams

## Upper Cover

Number	Description	Part Number
1		
2		
3		
4		
5		
6		
7		

---

## Lower Cover





Number	Description	Part Number
1		
2		
3		
4		







---

# LCD Panel





Number	Description	Part Number
1		
2		
3		
4		
5		
6		
7		
8		
9		
10		

## Aspire 7730/7730G FRU List



Category	Description	Part Number
Adapter		
	ADAPTER 65W 3PIN DELTA SADP-65KB DFA	AP.06501.013
	ADAPTER 65W LITEON PA-1650-02AC LF	AP.06503.016
	ADAPTER 65W 3PIN HIPRO AC-OK065B13	AP.0650A.010
	ADAPTER DELTA 90W ADP-90SB BBEA LF	AP.09001.013
	ADAPTER LITE-ON 90W 19V BLUE PA-1900-24AR LED LF	AP.09003.011
	ADAPTER HIPRO 90W 19V BLUE HP-OL093B13P LED LF LEVEL 4	AP.0900A.001
Battery		
	Battery SONY AS-2007B Li-Ion 3S2P SONY 6 cell 4400mAh Main COMMON Normal Type	BT.00604.025
	Battery PANASONIC AS-2007B Li-Ion 3S2P PANASONIC 6 cell 4400mAh Main COMMON PSS	BT.00605.021
	Battery SANYO AS-2007B Li-Ion 3S2P SANYO 6 cell 4400mAh Main COMMON Normal Type	BT.00603.042
	Battery SIMPLO AS-2007B Li-Ion 3S2P PANASONIC 6 cell 4400mAh Main COMMON PSS	BT.00607.016
	Battery PANASONIC AS-2007B Li-Ion 4S2P PANASONIC 8 cell 4800mAh Main COMMON	BT.00805.011
	Battery SANYO AS-2007B Li-Ion 4S2P SANYO 8 cell 4800mAh Main COMMON	BT.00803.024
	Battery SIMPLO AS-2007B Li-Ion 4S2P PANASONIC 8 cell 4800mAh Main COMMON PSS	BT.00807.015
	Battery SONY AS-2007B Li-Ion 4S2P SONY 8 cell 4800mAh Main COMMON	BT.00804.020
Board		
	Foxconn Delphi-AM5 V2H 1.5_3.3v T60M951.41	FX.22500.022
	BLUETOOTH MODULE (T60H928.11)	BT.21100.005
	WIRELESS LAN CARD FOXCONN T60h976.00 MINI	54.AZL07.001
	WIRELESS LAN BOARD 802.11BG FOXCONN BCM4312 T77H030.00	NI.23600.029
	Lan Intel WLAN 512AN_HMWG Shirley Peak 5100 MM#895373	KI.SPH01.003
	Lan Intel WLAN 512AN_MMWG Shirley Peak 5100 MM#895361	KI.SPM01.003
	Lan Intel WLAN 533AN_HMWG Shirley Peak MM#895401	KI.SPH01.001
	Lan Intel WLAN 533AN_MMWG Shirley Peak MM#895362	KI.SPM01.001
	TOUCHPAD BOARD W/O FP	55.AS307.001
	TOUCHPAD BOARD W/ FP	55.AR907.001
	POWER BOARD	55.AR907.002
	SWITCH BOARD	55.AR907.003
	EMPOWER BOARD	55.AR907.004



Category	Description	Part Number
	NEWCARD BOARD	55.TPK07.004
	MSI VGA Card nVidia NB9P-GS DDRIII 512M 800MHz 32*32 MXM II w/ HDCP w/ Intersil PowerIC	VG.9PG06.002
	MSI VGA Card nVidia NB9M-GS DDRII 256M 400MHz 32*16 MXM I w/ HDCP w/ Intersil PowerIC	VG.9MG06.001
	DVB-T MINI TUNER CARD A310 W/CONN & ADA	TU.23100.010
	INVERTER BOARD	19.TPK07.001
Cables		
	PWR CORD V943B30001218008 DANISH 3P	27.A03V7.006
	PWR CORD (ISR) 1.8M 3PBLK FZ0I0008-038	27.TATV7.005
	PWR CORD V50CB3T3012180QD TW-110V,3P	27.A99V7.002
	POWER CORD (SWI) 1.8M 3PBLACK FZ010008-011	27.A99V7.004
	POWER CORD (IT) 1.8M 3PBLACK FZ010008-008	27.A99V7.005
	POWER CORD (S.A) 1.8M 3BLACK FZ010008-006	27.T48V7.001
	POWER CORD US 3PIN ROHS	27.TAXV7.001
	POWER CORD (EU) 1.8M 3PBLACK FM010008-010	27.TATV7.001
	POWER CORD (UK) 1.8M 3PBLACK FP010008-013	27.TATV7.003
	BLUETOOTH CABLE	50.TPK07.001
	NEW CARD CABLE	50.TPK07.002
	FFC CABLE - POWER/B TO MB	50.AR907.001
	LCD CABLE FOR CCD	50.AR907.002

Category	Description	Part Number
Assembly Parts		
	MIDDLE COVER	42.AR907.001
	UPPER CASE W/SPEAKER, FFC, CABLE,TP FOR NON-FP	60.AS307.001
	UPPER CASE W/SPEAKER, FFC, CABLE,TP FOR FP	60.AR907.001
	LOWER CASE ASSY W/SUB-WOOF,RJ11 W/O TV	60.AR907.002
	LOWER CASE ASSY W/SUB-WOOF,RJ11,TV OUT CABLE	60.AS307.002
	RAM COVER	42.AR907.002
	HDD COVER -1	42.AR907.003
	HDD COVER - 2ND	42.AR907.004
	DDR BRACKET	33.AR907.001
	TP BRACKET	33.AR907.002
	ODD CAP	42.AR907.007
	VGA SUPPORT BRACKET	33.AHS07.007
	MIDDLE COVER TEXTURE	TBD
	UPPER CASE TEXTURE W/SPEAKER, FFC, CABLE,TP FOR NON-FP	TBD
	LOWER CASE ASSY W/SUB-WOOF,RJ11 W/O TV HDMI	TBD
	OPTICAL BRACKET	33.AR907.003
	DVD/CDRW COMBO BEZEL	42.AR907.005
	OPTICAL BRACKET	33.AR907.003
	ODD BEZEL - SUPER MULTI	42.AGW07.004
	OPTICAL BRACKET	33.AR907.003
	BD COMBO BEZEL	42.AR907.006
	HDD MASTER BRACKET	33.AR907.005
	HDD BRACKET ASSY	33.AR907.004
	HDD CONNECTOR	20.AR907.001

Category	Description	Part Number
	LCD BEZEL TEXTURE FOR CCD	
	LCD COVER HOLO 3D MIMO W/ 3 ANTENNA	60.AR907.004
	LCD BEZEL PAINTING FOR CCD	60.AR907.005
	LCD BRACKET W/HINGE - R	33.AR907.006
	LCD BRACKET W/HINGE - L	33.AR907.007
	LCD COVER ASSY W/MIC W/ANTENNA	
	LCD COVER HOLO 3D W/ 2 ANTENNA	60.AR907.006
CCD		
	CAMERA CN0314-SN30-OV03 SUYIN	57.TPK07.001
	CAMERA CNF701721004971L CNY	57.TPK07.002
CPU/PROCESSOR		
	CPU Intel Core2Dual T9600 PGA 2.8G 6M 1066 35W	KC.96001.DTP
	CPU Intel Core2Dual T9400 PGA 2.53G 6M 1066 35W	KC.94001.DTP
	CPU Intel Core2Dual P8600 PGA 2.4G 1066 25W 3M	KC.86001.DPP
	CPU Intel Core2Dual P8400 PGA 2.26G 3M 1066 25W	KC.84001.DPP
	CPU Intel Core2Dual P9500 PGA 2.53G 6M 1066 25W	KC.95001.DPP
Combo Drive		
	DVD/CDRW COMBO MODULE	6M.AR907.001
	TOSHIBA COMBO Tray DL 24X TS-L463A LF W/O bezel SATA	KO.02401.006
	SONY COMBO Tray DL 24X CRX890S LF W/O bezel SATA	KO.0240E.009
	BLUE RAY COMBO TRAY 2X SONY BC-5500S-AR	KO.0020E.002
DVD RW DRIVE		
	DVD/RW SUPER MULTI MODULE	6M.AR907.002
	TOSHIBA Super-Multi DRIVE Tray DL 8X TS-L633A LF W/O bezel SATA	KU.00801.021
	PIONEER Super-Multi DRIVE Tray DL 8X DVR-TD08RS LF W/O bezel SATA	KU.00805.044
	HLDS Super-Multi DRIVE Tray DL 8X GSA-T50N LF W/O bezel SATA Malaysia	TBD
	ODD HLDS Super-Multi DRIVE 12.7mm Tray DL 8X GSA-T50N LF W/O bezel SATA FW:RP05	KU.0080D.029
	ODD HLDS Super-Multi DRIVE 12.7mm Tray DL 8X GSA-T50N LF W/O bezel SATA Malaysia FW:RP05	KU.0080D.034
	BLUE RAY COMBO MODULE	6M.AR907.003



Category	Description	Part Number
Hard Disk		
	HDD TOSHIBA 5400rpm 120GB MK1246GSX Leo BS SATA I LF F/W:LB213J	KH.12004.007
	HDD WD 5400rpm 120GB WD1200BEVS-22UST0 ML125 SATA LF F/W:01.01A01	KH.12008.019
	HDD TOSHIBA 5400rpm 160GB MK1646GSX Leo BS SATA I LF F/W:LB113J	KH.16004.002
	HDD WD 2.5" 5400rpm 160GB WD1600BEVT-22ZCTO ML160 SATA LF F/W:11.01A11	KH.16008.022
	HDD SEAGATE 2.5" 5400rpm 250GB ST9250827AS Corsair SATA LF F/W:3.AAA	KH.25001.011
	HDD TOSHIBA 2.5" 5400rpm 320GB MK3252GSX Virgo BS SATA LF F/W:LV010J	KH.32004.001
Heatsink		
	THERMAL MODULE - UMA	60.AQF07.001
	THERMAL MODULE - DIS	60.AR907.003
Keyboard		
	Keyboard 17KB-FV3 Black Mammoth 105KS Black US International Hebrew	KB.INT00.478
	Keyboard 17KB-FV3 Black Mammoth 105KS Black US International	KB.INT00.478
	Keyboard 17KB-FV3 Black Mammoth 106KS Black UK	KB.INT00.480
	Keyboard 17KB-FV3 Black Mammoth 106KS Black Turkish	KB.INT00.481
	Keyboard 17KB-FV3 Black Mammoth 105KS Black Thailand	KB.INT00.482
	Keyboard 17KB-FV3 Black Mammoth 106KS Black Swiss/G	KB.INT00.483
	Keyboard 17KB-FV3 Black Mammoth 106KS Black Swedish	KB.INT00.484
	Keyboard 17KB-FV3 Black Mammoth 106KS Black Spanish	KB.INT00.485
	Keyboard 17KB-FV3 Black Mammoth 106KS Black Slovak	KB.INT00.486
	Keyboard 17KB-FV3 Black Mammoth 106KS Black SLO/ CRO	KB.INT00.487
	Keyboard 17KB-FV3 Black Mammoth 105KS Black Russian	KB.INT00.488
	Keyboard 17KB-FV3 Black Mammoth 106KS Black Portuguese	KB.INT00.489
	Keyboard 17KB-FV3 Black Mammoth 106KS Black Polish	KB.INT00.490
	Keyboard 17KB-FV3 Black Mammoth 106KS Black Norwegian	KB.INT00.491
	Keyboard 17KB-FV3 Black Mammoth 105KS Black Korean	KB.INT00.493
	Keyboard 17KB-FV3 Black Mammoth 106KS Black Italian	KB.INT00.494
	Keyboard 17KB-FV3 Black Mammoth 106KS Black Hungarian	KB.INT00.497
	Keyboard 17KB-FV3 Black Mammoth 105KS Black Greek	KB.INT00.498
	Keyboard 17KB-FV3 Black Mammoth 106KS Black German	KB.INT00.499
	Keyboard 17KB-FV3 Black Mammoth 106KS Black French	KB.INT00.500
Keyboard 17KB-FV3 Black Mammoth 106KS Black Danish	KB.INT00.503	
Keyboard 17KB-FV3 Black Mammoth 106KS Black Czech	KB.INT00.504	

Category	Description	Part Number
	Keyboard 17KB-FV3 Black Mammoth 105KS Black Traditional Chinese	KB.INT00.505
	Keyboard 17KB-FV3 Black Mammoth 106KS Black Canadian French	KB.INT00.506
	Keyboard 17KB-FV3 Black Mammoth 106KS Black Brazilian Portuguese	KB.INT00.507
	Keyboard 17KB-FV3 Black Mammoth 106KS Black Belgium	KB.INT00.508
	Keyboard 17KB-FV3 Black Mammoth 105KS Black Arabic/English	KB.INT00.509
	Keyboard 17KB-FV3 Black Mammoth 106KS Black Nordic	KB.INT00.511
LCD Panel		
	LCD MODULE ASSY17.1 WXGA+G HOLO 3D 3 ANTENNA W/CCD	6M.AR907.004
	LCD AUO 17.1" WXGA+ Glare B170PW06 V2 LF 220nit 8ms	LK.17105.009
	LCD SAMSUNG 17.1" WXGA+ Glare LTN170BT07-G01 LF 220nit 8ms 500:1	LK.17106.004
	LCD LPL 17.1" WXGA+ Glare LP171WP4-TLR1 LF 220nit 8ms	LK.17108.011
	LCD MODULE ASSY17.1 WXGA+G HOLO 3D 2 ANTENNA W/CCD	6M.AR907.005
Mainboard		
	MAINBOARD DIS PM45 ICH9 DDRIII GL W/CARD READER W/O CPU RAM	MB.ARC06.001
	MAINBOARD UMA GM45 ICH9 DDRII GL W/CARD READER W/O CPU RAM	MB.AQF06.001
Memory		
	SO-DIMM DDRII 667 NANYA 1GB NT1GT64U8HB0BN-3C (0.09U)	KN.1GB03.014
	Memory HYNIX SO-DIMM DDRII 667 1GB HYMP112S64CP6-Y5 LF	KN.1GB0G.012
	SO-DIMM DDRII667 512MB NT512T64UH8B0FN-37C (0.09U)\NANYA	KN.51203.032
	Memory MICRON SO-DIMM DDRII 667 2GB MT16HTF25664HY-667E1 LF	KN.2GB04.001
	Memory SAMSUNG SO-DIMM DDRII 667 2GB M470T5663QZ3-CE6 LF	KN.2GB0B.003
	Memory SAMSUNG SO-DIMM DDRIII 1066 1GB M471B2874DZ1-CF8 LF	KN.1GB0B.019
	Memory SAMSUNG SO-DIMM DDRIII 1066 2GB M471B5673DZ1-CF8 LF	KN.2GB0B.005
	Memory MICRON SO-DIMM DDRIII 1066 1GB MT8JSF12864HY-1G1D1 LF 64*16 0.07um	KN.1GB04.003
	Memory MICRON SO-DIMM DDRIII 1066 2GB MT16JSF25664HY-1G1D1 LF 128*8 0.07um	KN.2GB04.004
SATA HDD/HARD DISK DRIVE		
	HDD SEAGATE 2.5" 5400rpm 120GB ST9120817AS Corsair SATA LF F/W:3.AAA	KH.12001.032

Category	Description	Part Number
	HDD(160G) ST9160827AS 9DG133-188 STN B/S SEAGATE F/W:3.AAA	KH.16001.029
	HDD HGST 2.5" 5400rpm 160GB HTS542516K9SA00 Bronco-B SATA II LF F/W:C31P	KH.16007.016
	HDD TOSHIBA 2.5" 5400rpm 250GB MK2546GSX Leo BS SATA I LF F/W:LB013J	KH.25004.001
	HDD WD 2.5 IN. 5400rpm 250GB WD2500BEVS-22UST0 ML125 SATA LF F/W:01.01A01	KH.25008.018
	HDD WD 2.5" 5400rpm 320GB WD3200BEVT-22ZCT0 ML160 SATA LF F/W:11.01A11	KH.32008.013
	HDD 250GB 5400RPM SATA II HGST HTS542525K9SA00 LF F/W:C31P	KH.25007.011
	HDD HGST 2.5" 5400rpm 500GB HTS545050KTA300 Bronco K SATA LF F/W:C60G	KH.50007.007
Speaker		
	SPEAKER	23.AR907.001
Accessory		
Miscellaneous		
	NAME PLATE AS7730	40.AR907.001
	LCD GLOSS RUBBER PAD	47.AR907.002
	RUBBER FOOT	47.AR907.003
	RUBBER FOOT LOW	47.AR907.004

#### Screw List

Category	Description	Part Number
Screw List		
SCREW	SCREW M2.5*6.5-I(BZN)(NYLOK-RED)	86.ARE07.001
SCREW	SCREW M2.0*3.0-I(BKAG)(NYLOK IRON	86.ARE07.002
SCREW	SCREW M2.5*3.0-I(BNI)(NYLOK)	86.T25V7.012
SCREW	SCREW M2.0*3.0-I-NI-NYLOK	86.A08V7.005
SCREW	SCREW M2.0*2-I(BNI)(NYLOK)IRON	86.AR907.001
SCREW	SCREW M3.0*3.0-I(BZN)(NYLOK)IRON	86.AR907.002

## Model Definition and Configuration

### Aspire 7730/7730G Series

Model	RO	Country	Acer Part no	Description	CPU	LCD	DIMM 1	DIMM 2	HDD 1 (GB)	ODD	Wireless LAN	Bluetooth	VOIP Phone
AS5051ANW XMi	AAP	India	LX.AV30C.002	AS5051AN WXMi LINPUSIL1 UMAC 1*512/80/6L/5R/CB_bg_0.3 C_AN	ATMK36	N14.1 WXGAG	SO512 MBII5	N	N80G B5.4K	NSM8 X	ABT_ATH54 13BG	N	N
AS5051ANW XMi	AAP	Indonesia	LX.AV30C.003	AS5051AN WXMi LINPUSIN1 UMAC 1*512/80/6L/5R/CB_bg_0.3 C_AN	ATMK36	N14.1 WXGAG	SO512 MBII5	N	N80G B5.4K	NSM8 X	ABT_ATH54 13BG	N	N
AS5051ANW XMi	AAP	Malaysia	LX.AV30C.005	AS5051AN WXMi LINPUSMA2 UMAC 1*512/80/6L/5R/CB_bg_0.3 C_AN	ATMK36	N14.1 WXGAG	SO512 MBII5	N	N80G B5.4K	NSM8 X	ABT_ATH54 13BG	N	N
AS5051ANW XMi	AAP	Philippines	LX.AV30C.004	AS5051AN WXMi LINPUSPH1 UMAC 1*512/80/6L/5R/CB_bg_0.3 C_AN	ATMK36	N14.1 WXGAG	SO512 MBII5	N	N80G B5.4K	NSM8 X	ABT_ATH54 13BG	N	N
AS5051ANW XMi	AAP	Singapore	LX.AV30C.001	AS5051AN WXMi LINPUSSG1 UMAC 1*512/80/6L/5R/CB_bg_0.3 C_AN	ATMK36	N14.1 WXGAG	SO512 MBII5	N	N80G B5.4K	NSM8 X	ABT_ATH54 13BG	N	N
AS5051ANW XMi	AAP	Thailand	LX.AV30C.006	AS5051AN WXMi LINPUSTH2 UMAC 1*512/80/6L/5R/CB_bg_0.3 C_AN	ATMK36	N14.1 WXGAG	SO512 MBII5	N	N80G B5.4K	NSM8 X	ABT_ATH54 13BG	N	N
AS5051ANW XMi	AAP	Vietnam	LX.AV30C.007	AS5051AN WXMi LINPUSVN1 UMAC 1*512/80/6L/5R/CB_bg_0.3 C_AN	ATMK36	N14.1 WXGAG	SO512 MBII5	N	N80G B5.4K	NSM8 X	ABT_ATH54 13BG	N	N

Model	RO	Country	Acer Part no	Description	CPU	LCD	DIMM 1	DIMM 2	HDD 1 (GB)	ODD	Wireless LAN	Bluetooth	VOIP Phone
AS5051AWX Mi	PA	USA/Canada - Canadian French	LX.AV 30J.00 1	AS5051AW XMi MCECF UMAC 2*512/120/6L/5R/ CB_bg_0.3 C_AN	ATMK 36	N14.1 WXGAG	SO512 MBII5	SO512 MBII5	N120 GB5.4 K	NSM8 X	ABT_ATH54 13BG	N	N
AS5051AWX Mi	PA	USA/Canada - Canadian French	LX.AV 30J.00 2	AS5051AW XMi MCEUS UMAC 2*512/120/6L/5R/ CB_bg_0.3 C_AN	ATMK 36	N14.1 WXGAG	SO512 MBII5	SO512 MBII5	N120 GB5.4 K	NSM8 X	ABT_ATH54 13BG	N	N
AS5051AWX Mi	AAP	Australia/ New Zealand	LX.AV 305.00 1	AS5051AW XMi XPHAU1 UMAC 1*512/120/6L/5R/ CB_bg_0.3 C_AN	ATMK 36	N14.1 WXGAG	SO512 MBII5	N	N120 GB5.4 K	NSM8 X	ABT_ATH54 13BG	N	N
AS5051AWX Mi	PA	USA/Canada	LX.AV 305.00 8	AS5051AW XMi XPHEN1 UMAC 1*512/120/6L/5R/ CB_bg_0.3 C_AN	ATMK 36	N14.1 WXGAG	SO512 MBII5	N	N120 GB5.4 K	NSM8 X	ABT_ATH54 13BG	N	N
AS5051AWX Mi	PA	ACLA-Spanish	LX.AV 305.01 0	AS5051AW XMi XPHES1 UMAC 1*512/120/6L/5R/ CB_bg_0.3 C_AN	ATMK 36	N14.1 WXGAG	SO512 MBII5	N	N120 GB5.4 K	NSM8 X	ABT_ATH54 13BG	N	N
AS5051AWX Mi	PA	USA/Canada	LX.AV 305.00 9	AS5051AW XMi XPHFR1 UMAC 1*512/120/6L/5R/ CB_bg_0.3 C_AN	ATMK 36	N14.1 WXGAG	SO512 MBII5	N	N120 GB5.4 K	NSM8 X	ABT_ATH54 13BG	N	N
AS5051AWX Mi	AAP	Indonesia	LX.AV 305.00 7	AS5051AW XMi XPHIN1 UMAC 1*512/120/6L/5R/ CB_bg_0.3 C_AN	ATMK 36	N14.1 WXGAG	SO512 MBII5	N	N120 GB5.4 K	NSM8 X	ABT_ATH54 13BG	N	N
AS5051AWX Mi	AAP	Malaysia	LX.AV 305.00 3	AS5051AW XMi XPHMA2 UMAC 1*512/120/6L/5R/ CB_bg_0.3 C_AN	ATMK 36	N14.1 WXGAG	SO512 MBII5	N	N120 GB5.4 K	NSM8 X	ABT_ATH54 13BG	N	N
AS5051AWX Mi	AAP	Philippines	LX.AV 305.00 2	AS5051AW XMi XPHPH1 UMAC 1*512/120/6L/5R/ CB_bg_0.3 C_AN	ATMK 36	N14.1 WXGAG	SO512 MBII5	N	N120 GB5.4 K	NSM8 X	ABT_ATH54 13BG	N	N

Model	RO	Country	Acer Part no	Description	CPU	LCD	DIMM 1	DIMM 2	HDD 1 (GB)	ODD	Wireless LAN	Bluetooth	VOIP Phone
AS5051AWX Mi	AAP	Thailand	LX.AV 305.004	AS5051AW XMi XPTH2 UMAC 1*512/120/6L/5R/ CB_bg_0.3 C_AN	ATMK 36	N14.1 WXGAG	SO512 MBII5	N	N120 GB5.4 K	NSM8 X	ABT_ATH54 13BG	N	N
AS5051AWX Mi	AAP	Vietnam	LX.AV 305.005	AS5051AW XMi XPHVN1 UMAC 1*512/120/6L/5R/ CB_bg_0.3 C_AN	ATMK 36	N14.1 WXGAG	SO512 MBII5	N	N120 GB5.4 K	NSM8 X	ABT_ATH54 13BG	N	N
AS5051AWX Mi	AAP	Singapore	LX.AV 305.006	AS5051AW XMi XPHWSG2 1W UMAC 1*512/120/6L/5R/ CB_bg_0.3 C_AN	ATMK 36	N14.1 WXGAG	SO512 MBII5	N	N120 GB5.4 K	NSM8 X	ABT_ATH54 13BG	N	N
AS5051AWX Mi	PA	ACLA-Portuguese	LX.AV 305.011	AS5051AW XMi XPHXC1 UMAC 1*512/120/6L/5R/ CB_bg_0.3 C_AN	ATMK 36	N14.1 WXGAG	SO512 MBII5	N	N120 GB5.4 K	NSM8 X	ABT_ATH54 13BG	N	N
AS5051AWX Mi	TWN	GCTWN	S2.AV 305.001	AS5051AW XMi XPHTC1 UMAC 2*512/120/ BT/6L/5R/ CB_bg_0.3 C_AN	ATMK 36	N14.1 WXGAG	SO512 MBII6	SO512 MBII6	N120 GB5.4 K	NSM8 X	ABT_ATH54 13BG	FOX_BRM_2.0	N
AS5052WXM i	TWN	GCTWN	S2.AV 305.002	AS5052WX Mi XPHTC1 UMAC 2*512/100/ BT/6L/5R/ CB_bg_0.3 C_AN	ATTL50	N14.1 WXGAG	SO512 MBII6	SO512 MBII6	N100 GB5.4 K	NSM8 X	ABT_ATH54 13BG	FOX_BRM_2.0	N
AS5055WXM i	TWN	GCTWN	S2.AV 305.003	AS5055WX Mi XPHTC1 UMAC 2*1G/160/ BT/6L/5R/ CB_bg_0.3 C_AN	ATTL60	N14.1 WXGAG	SO1G BII5	SO1G BII5	N160 GB5.4 KS	NSM8 X	ABT_BRM4 318BG	FOX_BRM_2.0	N
AS5051AWX Ci	China	Hong Kong	LX.AV 305.016	AS5051AW XCi XPHHK9 UMAC 1*512/120/6L/5R/ CB_bg_0.3 C_AN	ATMK 36	N14.1 WXGAG	SO512 MBII5	N	N120 GB5.4 K	NCB2 4X	ABT_ATH54 13BG	N	N
AS5051AWX Ci	China	China	LX.AV 305.015	AS5051AW XCi XPHSC7 UMAC 1*512/120/6L/5R/ CB_bg_0.3 C_AN	ATMK 36	N14.1 WXGAG	SO512 MBII5	N	N120 GB5.4 K	NCB2 4X	ABT_ATH54 13BG	N	N

Model	RO	Country	Acer Part no	Description	CPU	LCD	DIMM 1	DIMM 2	HDD 1 (GB)	ODD	Wireless LAN	Bluetooth	VOIP Phone
AS5051AWX Mi	TWN	GCTWN	LX.AV 305.01 2	AS5051AW XMi XPHTC1 UMAC 1*512/120/ BT/6L/5R/ CB_bg_0.3 C_AN	ATMK 36	N14.1 WXGAG	SO512 MBII5	N	N120 GB5.4 K	NSM8 X	ABT_ATH54 13BG	FOX_BRM_2.0	N
AS5051AWX Mi	TWN	GCTWN	LX.AV 305.01 4	AS5051AW XMi XPHTC1 UMAC 1*512/60/ BT/6L/5R/ CB_bg_0.3 C_AN	ATMK 36	N14.1 WXGAG	SO512 MBII5	N	N60G B5.4K	NSM8 X	ABT_ATH54 13BG	FOX_BRM_2.0	N
AS5051AWX Mi	TWN	GCTWN	LX.AV 305.01 3	AS5051AW XMi XPHTC1 UMAC 1*512/80/ BT/6L/5R/ CB_bg_0.3 C_AN	ATMK 36	N14.1 WXGAG	SO512 MBII5	N	N80G B5.4K	NSM8 X	ABT_ATH54 13BG	FOX_BRM_2.0	N
AS5051AWX Mi	AAP	Australia/ New Zealand	LX.AV 30J.01 1	AS5051AW XMi MCEAU1 UMAC 1*1G/120/ 6L/5R/ CB_bg_0.3 C_AN	ATMK 36	N14.1 WXGAG	SO1G BII6	N	N120 GB5.4 K	NSM8 X	ABT_ATH54 13BG	N	N
AS5051AWX Mi	AAP	Singapore	LX.AV 30J.01 2	AS5051AW XMi MCESG1 UMAC 1*1G/120/ 6L/5R/ CB_bg_0.3 C_AN	ATMK 36	N14.1 WXGAG	SO1G BII6	N	N120 GB5.4 K	NSM8 X	ABT_ATH54 13BG	N	N
AS5051AWX Mi	AAP	India	LX.AV 30J.01 3	AS5051AW XMi MCEIL1 UMAC 1*1G/120/ 6L/5R/ CB_bg_0.3 C_AN	ATMK 36	N14.1 WXGAG	SO1G BII6	N	N120 GB5.4 K	NSM8 X	ABT_ATH54 13BG	N	N
AS5051AWX Mi	AAP	Indonesia	LX.AV 30J.01 4	AS5051AW XMi MCEIN1 UMAC 1*1G/120/ 6L/5R/ CB_bg_0.3 C_AN	ATMK 36	N14.1 WXGAG	SO1G BII6	N	N120 GB5.4 K	NSM8 X	ABT_ATH54 13BG	N	N
AS5051AWX Mi	AAP	Philippines	LX.AV 30J.01 5	AS5051AW XMi MCEPH1 UMAC 1*1G/120/ 6L/5R/ CB_bg_0.3 C_AN	ATMK 36	N14.1 WXGAG	SO1G BII6	N	N120 GB5.4 K	NSM8 X	ABT_ATH54 13BG	N	N
AS5051AWX Mi	AAP	Malaysia	LX.AV 30J.01 6	AS5051AW XMi MCEMA1 UMAC 1*1G/120/ 6L/5R/ CB_bg_0.3 C_AN	ATMK 36	N14.1 WXGAG	SO1G BII6	N	N120 GB5.4 K	NSM8 X	ABT_ATH54 13BG	N	N

Model	RO	Country	Acer Part no	Description	CPU	LCD	DIMM 1	DIMM 2	HDD 1 (GB)	ODD	Wireless LAN	Bluetooth	VOIP Phone
AS5051AWX Mi	AAP	Thailand	LX.AV 30J.017	AS5051AW XMi MCETH1 UMAC 1*1G/120/6L/5R/ CB_bg_0.3 C_AN	ATMK 36	N14.1 WXGAG	SO1G BII6	N	N120 GB5.4 K	NSM8 X	ABT_ATH54 13BG	N	N
AS5051AWX Mi	AAP	Vietnam	LX.AV 30J.018	AS5051AW XMi MCEVN1 UMAC 1*1G/120/6L/5R/ CB_bg_0.3 C_AN	ATMK 36	N14.1 WXGAG	SO1G BII6	N	N120 GB5.4 K	NSM8 X	ABT_ATH54 13BG	N	N
AS5051AWX Mi	AAP	Australia/ New Zealand	LX.AV 306.002	AS5051AW XMi XPPAU1 UMAC 1*1G/120/6L/5R/ CB_bg_0.3 C_AN	ATMK 36	N14.1 WXGAG	SO1G BII6	N	N120 GB5.4 K	NSM8 X	ABT_ATH54 13BG	N	N
AS5052WXM i	AAP	Australia/ New Zealand	LX.AV 30J.003	AS5052WXM i MCEAU1 UMAC 1*1G/120/6L/5R/ CB_bg_0.3 C_AN	ATTL5 0	N14.1 WXGAG	SO1G BII6	N	N120 GB5.4 K	NSM8 X	ABT_ATH54 13BG	N	N
AS5052WXM i	AAP	India	LX.AV 30J.005	AS5052WXM i MCEIL1 UMAC 1*1G/120/6L/5R/ CB_bg_0.3 C_AN	ATTL5 0	N14.1 WXGAG	SO1G BII6	N	N120 GB5.4 K	NSM8 X	ABT_ATH54 13BG	N	N
AS5052WXM i	AAP	Indonesia	LX.AV 30J.006	AS5052WXM i MCEIN1 UMAC 1*1G/120/6L/5R/ CB_bg_0.3 C_AN	ATTL5 0	N14.1 WXGAG	SO1G BII6	N	N120 GB5.4 K	NSM8 X	ABT_ATH54 13BG	N	N
AS5052WXM i	AAP	Singapore	LX.AV 30J.004	AS5052WXM i MCESG1 UMAC 1*1G/120/6L/5R/ CB_bg_0.3 C_AN	ATTL5 0	N14.1 WXGAG	SO1G BII6	N	N120 GB5.4 K	NSM8 X	ABT_ATH54 13BG	N	N
AS5052WXM i	AAP	Philippines	LX.AV 30J.007	AS5052WXM i MCEPH1 UMAC 1*1G/120/6L/5R/ CB_bg_0.3 C_AN	ATTL5 0	N14.1 WXGAG	SO1G BII6	N	N120 GB5.4 K	NSM8 X	ABT_ATH54 13BG	N	N
AS5052WXM i	AAP	Malaysia	LX.AV 30J.008	AS5052WXM i MCEMA1 UMAC 1*1G/120/6L/5R/ CB_bg_0.3 C_AN	ATTL5 0	N14.1 WXGAG	SO1G BII6	N	N120 GB5.4 K	NSM8 X	ABT_ATH54 13BG	N	N



Model	RO	Country	Acer Part no	Description	CPU	LCD	DIMM 1	DIMM 2	HDD 1 (GB)	ODD	Wireless LAN	Bluetooth	VOIP Phone
AS5052WXM i	AAP	Thailand	LX.AV30J.009	AS5052WXM i MCETH1 UMAC 1*1G/120/ 6L/5R/ CB_bg_0.3 C_AN	ATTL50	N14.1 WXGA G	SO1G BII6	N	N120 GB5.4 K	NSM8 X	ABT_ ATH54 13BG	N	N
AS5052WXM i	AAP	Vietnam	LX.AV30J.010	AS5052WXM i MCEVN1 UMAC 1*1G/120/ 6L/5R/ CB_bg_0.3 C_AN	ATTL50	N14.1 WXGA G	SO1G BII6	N	N120 GB5.4 K	NSM8 X	ABT_ ATH54 13BG	N	N
AS5052WXM i	AAP	Australia/ New Zealand	LX.AV306.001	AS5052WXM i XPPAU1 UMAC 1*1G/120/ 6L/5R/ CB_bg_0.3 C_AN	ATTL50	N14.1 WXGA G	SO1G BII6	N	N120 GB5.4 K	NSM8 X	ABT_ ATH54 13BG	N	N
AS5051ANW XM i	AAP	India	LX.AV30C.015	AS5051ANW XM i LINPUSIL1 UMAC 1*256/60/ 6L/5R/ CB_bg_0.3 C_AN	ATMK36	N14.1 WXGA G	SO256 MBII5	N	N60G B5.4K	NSM8 X	ABT_ ATH54 13BG	N	N
AS5051ANW XM i	AAP	Vietnam	LX.AV30C.014	AS5051ANW XM i LINPUSVN1 UMAC 1*512/60/ 6L/5R/ CB_bg_0.3 C_AN	ATMK36	N14.1 WXGA G	SO512 MBII5	N	N60G B5.4K	NSM8 X	ABT_ ATH54 13BG	N	N
AS5051ANW XM i	AAP	Thailand	LX.AV30C.016	AS5051ANW XM i LINPUSH2 UMAC 1*512/80/ BT/6L/5R/ CB_bg_0.3 C_AN	ATMK36	N14.1 WXGA G	SO512 MBII5	N	N80G B5.4K	NSM8 X	ABT_ ATH54 13BG	FOX_ BRM_ 2.0	N
AS5051ANW XM i	AAP	Singapore	LX.AV30C.008	AS5051ANW XM i LINPUSSG1 UMAC 1*512/60/ 6L/5R/ CB_bg_0.3 C_AN	ATMK36	N14.1 WXGA G	SO512 MBII5	N	N60G B5.4K	NSM8 X	ABT_ ATH54 13BG	N	N
AS5051ANW XM i	AAP	India	LX.AV30C.009	AS5051ANW XM i LINPUSIL1 UMAC 1*512/60/ 6L/5R/ CB_bg_0.3 C_AN	ATMK36	N14.1 WXGA G	SO512 MBII5	N	N60G B5.4K	NSM8 X	ABT_ ATH54 13BG	N	N
AS5051ANW XM i	AAP	Indonesia	LX.AV30C.010	AS5051ANW XM i LINPUSIN1 UMAC 1*512/60/ 6L/5R/ CB_bg_0.3 C_AN	ATMK36	N14.1 WXGA G	SO512 MBII5	N	N60G B5.4K	NSM8 X	ABT_ ATH54 13BG	N	N

Model	RO	Country	Acer Part no	Description	CPU	LCD	DIMM 1	DIMM 2	HDD 1 (GB)	ODD	Wireless LAN	Bluetooth	VOIP Phone
AS5051ANW XMi	AAP	Philippines	LX.AV 30C.0 11	AS5051AN WXMi LINPUSPH 1 UMAC 1*512/60/ 6L/5R/ CB_bg_0.3 C_AN	ATMK 36	N14.1 WXGAG	SO512 MBII5	N	N60G B5.4K	NSM8 X	ABT_ATH54 13BG	N	N
AS5051ANW XMi	AAP	Malaysia	LX.AV 30C.0 12	AS5051AN WXMi LINPUSMA 2 UMAC 1*512/60/ 6L/5R/ CB_bg_0.3 C_AN	ATMK 36	N14.1 WXGAG	SO512 MBII5	N	N60G B5.4K	NSM8 X	ABT_ATH54 13BG	N	N
AS5051ANW XMi	AAP	Thailand	LX.AV 30C.0 13	AS5051AN WXMi LINPUSTH 2 UMAC 1*512/60/ 6L/5R/ CB_bg_0.3 C_AN	ATMK 36	N14.1 WXGAG	SO512 MBII5	N	N60G B5.4K	NSM8 X	ABT_ATH54 13BG	N	N
AS5052WXM i	AAP	Thailand	LX.AV 30J.01 9	AS5052WXM i MCETH1 UMAC 1*1G/120/ BT/6L/5R/ CB_bg_0.3 C_AN	ATTL5 0	N14.1 WXGAG	SO1G BII6	N	N120 GB5.4 K	NSM8 X	ABT_ATH54 13BG	FOX_ BRM_ 2.0	N
AS5051AWX Mi	EMEA	Belgium	LX.AV 30J.03 2	AS5051AW XMi MCEBE6 UMAC 2*512/100/ 6L/ 5R_bg_0.3 C_AN	ATMK 36	N14.1 WXGAG	SO512 MBII6	SO512 MBII6	N100 GB5.4 K	NSM8 X	ABT_ BRM4 318BG	N	N
AS5051AWX Mi	EMEA	Middle East	LX.AV 30J.04 3	AS5051AW XMi MCEAR1 UMAC 2*512/100/ 6L/ 5R_bg_0.3 C_AN	ATMK 36	N14.1 WXGAG	SO512 MBII6	SO512 MBII6	N100 GB5.4 K	NSM8 X	ABT_ BRM4 318BG	N	N
AS5051AWX Mi	EMEA	Middle East	LX.AV 30J.04 4	AS5051AW XMi MCEAR2 UMAC 2*512/100/ 6L/ 5R_bg_0.3 C_AN	ATMK 36	N14.1 WXGAG	SO512 MBII6	SO512 MBII6	N100 GB5.4 K	NSM8 X	ABT_ BRM4 318BG	N	N
AS5051AWX Mi	EMEA	Italy	LX.AV 30J.04 0	AS5051AW XMi MCEIT7 UMAC 2*512/100/ 6L/ 5R_bg_0.3 C_AN	ATMK 36	N14.1 WXGAG	SO512 MBII6	SO512 MBII6	N100 GB5.4 K	NSM8 X	ABT_ BRM4 318BG	N	N
AS5051AWX Mi	EMEA	Spain	LX.AV 30J.03 9	AS5051AW XMi MCEESJ UMAC 2*512/100/ 6L/ 5R_bg_0.3 C_AN	ATMK 36	N14.1 WXGAG	SO512 MBII6	SO512 MBII6	N100 GB5.4 K	NSM8 X	ABT_ BRM4 318BG	N	N

Model	RO	Country	Acer Part no	Description	CPU	LCD	DIMM 1	DIMM 2	HDD 1 (GB)	ODD	Wireless LAN	Bluetooth	VOIP Phone
AS5051AWX Mi	EMEA	Eastern Europe	LX.AV 30J.030	AS5051AW XMi MCECS5 UMAC 2*512/100/6L/ 5R_bg_0.3 C_AN	ATMK 36	N14.1 WXGA	SO512 MBII6	SO512 MBII6	N100 GB5.4 K	NSM8 X	ABT_BRM4 318BG	N	N
AS5051AWX Mi	EMEA	Denmark	LX.AV 30J.024	AS5051AW XMi MCEDK6 UMAC 2*512/100/6L/ 5R_bg_0.3 C_AN	ATMK 36	N14.1 WXGA	SO512 MBII6	SO512 MBII6	N100 GB5.4 K	NSM8 X	ABT_BRM4 318BG	N	N
AS5051AWX Mi	EMEA	France	LX.AV 30J.025	AS5051AW XMi MCEFRF UMAC 2*512/100/6L/ 5R_bg_0.3 C_AN	ATMK 36	N14.1 WXGA	SO512 MBII6	SO512 MBII6	N100 GB5.4 K	NSM8 X	ABT_BRM4 318BG	N	N
AS5051AWX Mi	EMEA	Germany	LX.AV 30J.027	AS5051AW XMi MCEDEA UMAC 2*512/100/6L/ 5R_bg_0.3 C_AN	ATMK 36	N14.1 WXGA	SO512 MBII6	SO512 MBII6	N100 GB5.4 K	NSM8 X	ABT_BRM4 318BG	N	N
AS5051AWX Mi	EMEA	Germany	LX.AV 30J.028	AS5051AW XMi MCEDEB UMAC 2*512/100/6L/ 5R_bg_0.3 C_AN	ATMK 36	N14.1 WXGA	SO512 MBII6	SO512 MBII6	N100 GB5.4 K	NSM8 X	ABT_BRM4 318BG	N	N
AS5051AWX Mi	EMEA	Holland	LX.AV 30J.033	AS5051AW XMi MCENL6 UMAC 2*512/100/6L/ 5R_bg_0.3 C_AN	ATMK 36	N14.1 WXGA	SO512 MBII6	SO512 MBII6	N100 GB5.4 K	NSM8 X	ABT_BRM4 318BG	N	N
AS5051AWX Mi	EMEA	Norway	LX.AV 30J.034	AS5051AW XMi MCENO5 UMAC 2*512/100/6L/ 5R_bg_0.3 C_AN	ATMK 36	N14.1 WXGA	SO512 MBII6	SO512 MBII6	N100 GB5.4 K	NSM8 X	ABT_BRM4 318BG	N	N
AS5051AWX Mi	EMEA	Russia	LX.AV 30J.035	AS5051AW XMi MCERU9 UMAC 2*512/100/6L/ 5R_bg_0.3 C_AN	ATMK 36	N14.1 WXGA	SO512 MBII6	SO512 MBII6	N100 GB5.4 K	NSM8 X	ABT_BRM4 318BG	N	N
AS5051AWX Mi	EMEA	Eastern Europe	LX.AV 30J.036	AS5051AW XMi MCEPL7 UMAC 2*512/100/6L/ 5R_bg_0.3 C_AN	ATMK 36	N14.1 WXGA	SO512 MBII6	SO512 MBII6	N100 GB5.4 K	NSM8 X	ABT_BRM4 318BG	N	N

Model	RO	Country	Acer Part no	Description	CPU	LCD	DIMM 1	DIMM 2	HDD 1 (GB)	ODD	Wireless LAN	Bluetooth	VOIP Phone
AS5051AWX Mi	EMEA	Slovenia/Croatia	LX.AV 30J.037	AS5051AW XMi MCES11 UMAC 2*512/100/6L/ 5R_bg_0.3 C_AN	ATMK 36	N14.1 WXGA	SO512 MBII6	SO512 MBII6	N100 GB5.4 K	NSM8 X	ABT_BRM4 318BG	N	N
AS5051AWX Mi	EMEA	Portugal	LX.AV 30J.038	AS5051AW XMi MCEPT6 UMAC 2*512/100/6L/ 5R_bg_0.3 C_AN	ATMK 36	N14.1 WXGA	SO512 MBII6	SO512 MBII6	N100 GB5.4 K	NSM8 X	ABT_BRM4 318BG	N	N
AS5051AWX Mi	EMEA	Sweden/Finland	LX.AV 30J.029	AS5051AW XMi MCESV5 UMAC 2*512/100/6L/ 5R_bg_0.3 C_AN	ATMK 36	N14.1 WXGA	SO512 MBII6	SO512 MBII6	N100 GB5.4 K	NSM8 X	ABT_BRM4 318BG	N	N
AS5051AWX Mi	EMEA	Turkey	LX.AV 30J.041	AS5051AW XMi MCETR5 UMAC 2*512/100/6L/ 5R_bg_0.3 C_AN	ATMK 36	N14.1 WXGA	SO512 MBII6	SO512 MBII6	N100 GB5.4 K	NSM8 X	ABT_BRM4 318BG	N	N
AS5051AWX Mi	EMEA	Switzerland	LX.AV 30J.045	AS5051AW XMi MCESW8 UMAC 2*512/100/6L/ 5R_bg_0.3 C_AN	ATMK 36	N14.1 WXGA	SO512 MBII6	SO512 MBII6	N100 GB5.4 K	NSM8 X	ABT_BRM4 318BG	N	N
AS5051AWX Mi	EMEA	UK	LX.AV 30J.046	AS5051AW XMi MCEUK5 UMAC 2*512/100/6L/ 5R_bg_0.3 C_AN	ATMK 36	N14.1 WXGA	SO512 MBII6	SO512 MBII6	N100 GB5.4 K	NSM8 X	ABT_BRM4 318BG	N	N
AS5051AWX Mi	EMEA	UK	LX.AV 30J.047	AS5051AW XMi MCEWUK1 1W UMAC 2*512/100/6L/ 5R_bg_0.3 C_AN	ATMK 36	N14.1 WXGA	SO512 MBII6	SO512 MBII6	N100 GB5.4 K	NSM8 X	ABT_BRM4 318BG	N	N
AS5051AWX Mi	EMEA	Italy	LX.AV 30J.042	AS5051AW XMi MCEWIT11 W UMAC 2*512/100/6L/ 5R_bg_0.3 C_AN	ATMK 36	N14.1 WXGA	SO512 MBII6	SO512 MBII6	N100 GB5.4 K	NSM8 X	ABT_BRM4 318BG	N	N
AS5051AWX Mi	EMEA	Germany	LX.AV 30J.031	AS5051AW XMi MCEWDE1 1W UMAC 2*512/100/6L/ 5R_bg_0.3 C_AN	ATMK 36	N14.1 WXGA	SO512 MBII6	SO512 MBII6	N100 GB5.4 K	NSM8 X	ABT_BRM4 318BG	N	N

Model	RO	Country	Acer Part no	Description	CPU	LCD	DIMM 1	DIMM 2	HDD 1 (GB)	ODD	Wireless LAN	Bluetooth	VOIP Phone
AS5051AWX Mi	EMEA	France	LX.AV 30J.026	AS5051AW XMi MCEWFR1 1W UMAC 2*512/100/6L/ 5R_bg_0.3 C_AN	ATMK 36	N14.1 WXGA	SO512 MBII6	SO512 MBII6	N100 GB5.4 K	NSM8 X	ABT_BRM4 318BG	N	N
AS5051AWX Mi	EMEA	Belgium	LX.AV 305.019	AS5051AW XMi XPHBE1 UMAC 2*512/100/6L/ 5R_bg_0.3 C_AN	ATMK 36	N14.1 WXGA	SO512 MBII6	SO512 MBII6	N100 GB5.4 K	NSM8 X	ABT_BRM4 318BG	N	N
AS5051AWX Mi	EMEA	Middle East	LX.AV 305.038	AS5051AW XMi XPHAR1 UMAC 2*512/100/6L/ 5R_bg_0.3 C_AN	ATMK 36	N14.1 WXGA	SO512 MBII6	SO512 MBII6	N100 GB5.4 K	NSM8 X	ABT_BRM4 318BG	N	N
AS5051AWX Mi	EMEA	Eastern Europe	LX.AV 305.027	AS5051AW XMi XPHCS2 UMAC 2*512/100/6L/ 5R_bg_0.3 C_AN	ATMK 36	N14.1 WXGA	SO512 MBII6	SO512 MBII6	N100 GB5.4 K	NSM8 X	ABT_BRM4 318BG	N	N
AS5051AWX Mi	EMEA	Germany	LX.AV 305.023	AS5051AW XMi XPHDE7 UMAC 2*512/100/6L/ 5R_bg_0.3 C_AN	ATMK 36	N14.1 WXGA	SO512 MBII6	SO512 MBII6	N100 GB5.4 K	NSM8 X	ABT_BRM4 318BG	N	N
AS5051AWX Mi	EMEA	Greece	LX.AV 305.033	AS5051AW XMi XPHL1 UMAC 2*512/100/6L/ 5R_bg_0.3 C_AN	ATMK 36	N14.1 WXGA	SO512 MBII6	SO512 MBII6	N100 GB5.4 K	NSM8 X	ABT_BRM4 318BG	N	N
AS5051AWX Mi	EMEA	Israel	LX.AV 305.034	AS5051AW XMi XPHIS1 UMAC 2*512/100/6L/ 5R_bg_0.3 C_AN	ATMK 36	N14.1 WXGA	SO512 MBII6	SO512 MBII6	N100 GB5.4 K	NSM8 X	ABT_BRM4 318BG	N	N
AS5051AWX Mi	EMEA	Italy	LX.AV 305.035	AS5051AW XMi XPHIT1 UMAC 2*512/100/6L/ 5R_bg_0.3 C_AN	ATMK 36	N14.1 WXGA	SO512 MBII6	SO512 MBII6	N100 GB5.4 K	NSM8 X	ABT_BRM4 318BG	N	N
AS5051AWX Mi	EMEA	Denmark	LX.AV 305.018	AS5051AW XMi XPHDK1 UMAC 2*512/100/6L/ 5R_bg_0.3 C_AN	ATMK 36	N14.1 WXGA	SO512 MBII6	SO512 MBII6	N100 GB5.4 K	NSM8 X	ABT_BRM4 318BG	N	N

Model	RO	Country	Acer Part no	Description	CPU	LCD	DIMM 1	DIMM 2	HDD 1 (GB)	ODD	Wireless LAN	Bluetooth	VOIP Phone
AS5051AWX Mi	EMEA	Holland	LX.AV 305.020	AS5051AW XMi XPHNL1 UMAC 2*512/100/6L/ 5R_bg_0.3 C_AN	ATMK 36	N14.1 WXGA	SO512 MBII6	SO512 MBII6	N100 GB5.4 K	NSM8 X	ABT_BRM4 318BG	N	N
AS5051AWX Mi	EMEA	France	LX.AV 305.021	AS5051AW XMi XPHFRA UMAC 2*512/100/6L/ 5R_bg_0.3 C_AN	ATMK 36	N14.1 WXGA	SO512 MBII6	SO512 MBII6	N100 GB5.4 K	NSM8 X	ABT_BRM4 318BG	N	N
AS5051AWX Mi	EMEA	Eastern Europe	LX.AV 305.028	AS5051AW XMi XPHHU6 UMAC 2*512/100/6L/ 5R_bg_0.3 C_AN	ATMK 36	N14.1 WXGA	SO512 MBII6	SO512 MBII6	N100 GB5.4 K	NSM8 X	ABT_BRM4 318BG	N	N
AS5051AWX Mi	EMEA	Spain	LX.AV 305.031	AS5051AW XMi XPHESA UMAC 2*512/100/6L/ 5R_bg_0.3 C_AN	ATMK 36	N14.1 WXGA	SO512 MBII6	SO512 MBII6	N100 GB5.4 K	NSM8 X	ABT_BRM4 318BG	N	N
AS5051AWX Mi	EMEA	Slovenia/Croatia	LX.AV 305.030	AS5051AW XMi XPHSLO2 UMAC 2*512/100/6L/ 5R_bg_0.3 C_AN	ATMK 36	N14.1 WXGA	SO512 MBII6	SO512 MBII6	N100 GB5.4 K	NSM8 X	ABT_BRM4 318BG	N	N
AS5051AWX Mi	EMEA	Eastern Europe	LX.AV 305.029	AS5051AW XMi XPHPL6 UMAC 2*512/100/6L/ 5R_bg_0.3 C_AN	ATMK 36	N14.1 WXGA	SO512 MBII6	SO512 MBII6	N100 GB5.4 K	NSM8 X	ABT_BRM4 318BG	N	N
AS5051AWX Mi	EMEA	Portugal	LX.AV 305.032	AS5051AW XMi XPHPT1 UMAC 2*512/100/6L/ 5R_bg_0.3 C_AN	ATMK 36	N14.1 WXGA	SO512 MBII6	SO512 MBII6	N100 GB5.4 K	NSM8 X	ABT_BRM4 318BG	N	N
AS5051AWX Mi	EMEA	Switzerland	LX.AV 305.039	AS5051AW XMi XPHSW5 UMAC 2*512/100/6L/ 5R_bg_0.3 C_AN	ATMK 36	N14.1 WXGA	SO512 MBII6	SO512 MBII6	N100 GB5.4 K	NSM8 X	ABT_BRM4 318BG	N	N
AS5051AWX Mi	EMEA	Turkey	LX.AV 305.036	AS5051AW XMi XPHTR1 UMAC 2*512/100/6L/ 5R_bg_0.3 C_AN	ATMK 36	N14.1 WXGA	SO512 MBII6	SO512 MBII6	N100 GB5.4 K	NSM8 X	ABT_BRM4 318BG	N	N

Model	RO	Country	Acer Part no	Description	CPU	LCD	DIMM 1	DIMM 2	HDD 1 (GB)	ODD	Wireless LAN	Bluetooth	VOIP Phone
AS5051AWX Mi	EMEA	South Africa	LX.AV 305.017	AS5051AW XMi XPHSA1 UMAC 2*512/100/6L/ 5R_bg_0.3 C_AN	ATMK 36	N14.1 WXGA	SO512 MBII6	SO512 MBII6	N100 GB5.4 K	NSM8 X	ABT_BRM4 318BG	N	N
AS5051AWX Mi	EMEA	Norway	LX.AV 305.024	AS5051AW XMi XPHNO1 UMAC 2*512/100/6L/ 5R_bg_0.3 C_AN	ATMK 36	N14.1 WXGA	SO512 MBII6	SO512 MBII6	N100 GB5.4 K	NSM8 X	ABT_BRM4 318BG	N	N
AS5051AWX Mi	EMEA	Russia	LX.AV 305.025	AS5051AW XMi XPHRU2 UMAC 2*512/100/6L/ 5R_bg_0.3 C_AN	ATMK 36	N14.1 WXGA	SO512 MBII6	SO512 MBII6	N100 GB5.4 K	NSM8 X	ABT_BRM4 318BG	N	N
AS5051AWX Mi	EMEA	Sweden/ Finland	LX.AV 305.026	AS5051AW XMi XPHSV1 UMAC 2*512/100/6L/ 5R_bg_0.3 C_AN	ATMK 36	N14.1 WXGA	SO512 MBII6	SO512 MBII6	N100 GB5.4 K	NSM8 X	ABT_BRM4 318BG	N	N
AS5051AWX Mi	EMEA	France	LX.AV 305.022	AS5051AW XMi XPHWFRB 1W UMAC 2*512/100/6L/ 5R_bg_0.3 C_AN	ATMK 36	N14.1 WXGA	SO512 MBII6	SO512 MBII6	N100 GB5.4 K	NSM8 X	ABT_BRM4 318BG	N	N
AS5051AWX Mi	EMEA	Italy	LX.AV 305.037	AS5051AW XMi XPHWIT21 W UMAC 2*512/100/6L/ 5R_bg_0.3 C_AN	ATMK 36	N14.1 WXGA	SO512 MBII6	SO512 MBII6	N100 GB5.4 K	NSM8 X	ABT_BRM4 318BG	N	N
AS5051AWX Mi	EMEA	UK	LX.AV 305.040	AS5051AW XMi XPHUK1 UMAC 2*512/100/6L/ 5R_bg_0.3 C_AN	ATMK 36	N14.1 WXGA	SO512 MBII6	SO512 MBII6	N100 GB5.4 K	NSM8 X	ABT_BRM4 318BG	N	N
AS5051AWX Mi	EMEA	UK	LX.AV 305.041	AS5051AW XMi XPHWUK2 1W UMAC 2*512/100/6L/ 5R_bg_0.3 C_AN	ATMK 36	N14.1 WXGA	SO512 MBII6	SO512 MBII6	N100 GB5.4 K	NSM8 X	ABT_BRM4 318BG	N	N
AS5052WXM i	PA	USA/ Canada - Canadian French	LX.AV 30J.020	AS5052WXM i MCECF UMAC 2*512/120/6L/5R/ CB_bg_0.3 C_AN	ATTL5 0	N14.1 WXGA G	SO512 MBII5	SO512 MBII5	N120 GB5.4 K	NSM8 X	ABT_ATH54 13BG	N	N

Model	RO	Country	Acer Part no	Description	CPU	LCD	DIMM 1	DIMM 2	HDD 1 (GB)	ODD	Wireless LAN	Bluetooth	VOIP Phone
AS5052WXM i	PA	USA/Canada - Canadian French	LX.AV 30J.021	AS5052WXM i MCEUS UMAC 2*512/120/6L/5R/CB_bg_0.3 C_AN	ATTL50	N14.1 WXGAG	SO512 MBII5	SO512 MBII5	N120 GB5.4 K	NSM8 X	ABT_ATH54 13BG	N	N
AS5052WXM i	PA	ACLA-Spanish	LX.AV 30J.022	AS5052WXM i MCEES1 UMAC 2*512/120/6L/5R/CB_bg_0.3 C_AN	ATTL50	N14.1 WXGAG	SO512 MBII5	SO512 MBII5	N120 GB5.4 K	NSM8 X	ABT_ATH54 13BG	N	N
AS5051AWX Mi	PA	ACLA-Spanish	LX.AV 30J.048	AS5051AWX Mi MCEES1 UMAC 2*512/120/6L/5R/CB_bg_0.3 C_AN	ATMK36	N14.1 WXGAG	SO512 MBII5	SO512 MBII5	N120 GB5.4 K	NSM8 X	ABT_BRM4 318BG	N	N
AS5051ANW XCi	AAP	Australia/New Zealand	LX.AV 30C.017	AS5051ANW XCi LINPUSAU 1 UMAC 1*512/80/6L/5R/CB_bg_0.3 C_AN	ATMK36	N14.1 WXGAG	SO512 MBII5	N	N80G B5.4K	NCB2 4X	ABT_BRM4 318BG	N	N
AS5051AWX Ci	AAP	Malaysia	LX.AV 305.042	AS5051AWX Ci XPHMA2 UMAC 1*512/80/6L/5R/CB_bg_0.3 C_AN	ATMK36	N14.1 WXGAG	SO512 MBII5	N	N80G B5.4K	NCB2 4X	ABT_BRM4 318BG	N	N
AS5051ANW XCi	AAP	Malaysia	LX.AV 30C.018	AS5051ANW XCi LINPUSMA 2 UMAC 1*512/80/6L/5R/CB_bg_0.3 C_AN	ATMK36	N14.1 WXGAG	SO512 MBII5	N	N80G B5.4K	NCB2 4X	ABT_BRM4 318BG	N	N
AS5051AWX Mi	EMEA	Sweden/Finland	LX.AV 30J.049	AS5051AWX Mi MCESV5 UMAC 1*512/100/BT/6L/5R/CB_bg_VP_0.3C_AN	ATMK36	N14.1 WXGAG	SO512 MBII6	N	N100 GB5.4 K	NSM8 X	ABT_BRM4 318BG	FOX_BRM_2.0	BT VoIP PCMC IA
AS5051AWX Mi	EMEA	Slovenia/Croatia	LX.AV 30J.050	AS5051AWX Mi MCES1 UMAC 1*512/100/BT/6L/5R/CB_bg_VP_0.3C_AN	ATMK36	N14.1 WXGAG	SO512 MBII6	N	N100 GB5.4 K	NSM8 X	ABT_BRM4 318BG	FOX_BRM_2.0	BT VoIP PCMC IA
AS5051AWX Mi	EMEA	Holland	LX.AV 30J.051	AS5051AWX Mi MCENL6 UMAC 1*512/100/BT/6L/5R/CB_bg_VP_0.3C_AN	ATMK36	N14.1 WXGAG	SO512 MBII6	N	N100 GB5.4 K	NSM8 X	ABT_BRM4 318BG	FOX_BRM_2.0	BT VoIP PCMC IA



Model	RO	Country	Acer Part no	Description	CPU	LCD	DIMM 1	DIMM 2	HDD 1 (GB)	ODD	Wireless LAN	Bluetooth	VOIP Phone
AS5051AWX Mi	EMEA	Russia	LX.AV 30J.05 2	AS5051AW XMi MCERU9 UMAC 1*512/100/ BT/6L/5R/ CB_bg_VP_0.3C_AN	ATMK 36	N14.1 WXGA G	SO512 MBII6	N	N100 GB5.4 K	NSM8 X	ABT_ BRM4 318BG	FOX_ BRM_ 2.0	BT VoIP PCMC IA
AS5051AWX Mi	EMEA	Holland	LX.AV 30J.05 4	AS5051AW XMi MCENL6 UMAC 1*512/100/ BT/6L/ 5R_bg_VP_0.3C_AN	ATMK 36	N14.1 WXGA	SO512 MBII6	N	N100 GB5.4 K	NSM8 X	ABT_ BRM4 318BG	FOX_ BRM_ 2.0	BT VoIP PCMC IA
AS5051AWX Mi	EMEA	Russia	LX.AV 305.04 3	AS5051AW XMi XPHRU2 UMAC 1*512/100/ 6L/ 5R_bg_0.3 C_AN	ATMK 36	N14.1 WXGA	SO512 MBII6	N	N100 GB5.4 K	NSM8 X	ABT_ BRM4 318BG	N	N
AS5051AWX Mi	EMEA	Sweden/ Finland	LX.AV 30J.05 5	AS5051AW XMi MCEV5 UMAC 1*512/100/ BT/6L/ 5R_bg_VP_0.3C_AN	ATMK 36	N14.1 WXGA	SO512 MBII6	N	N100 GB5.4 K	NSM8 X	ABT_ BRM4 318BG	FOX_ BRM_ 2.0	BT VoIP PCMC IA
AS5051AWX Mi	EMEA	Slovenia/ Croatia	LX.AV 30J.05 3	AS5051AW XMi MCES11 UMAC 1*512/100/ BT/6L/ 5R_bg_VP_0.3C_AN	ATMK 36	N14.1 WXGA	SO512 MBII6	N	N100 GB5.4 K	NSM8 X	ABT_ BRM4 318BG	FOX_ BRM_ 2.0	BT VoIP PCMC IA
AS5052NWX Mi	AAP	Thailand	LX.AV 30C.0 19	AS5052N WXMi LINPUSH 2 UMAC 1*512/120/ BT/6L/5R/ CB_bg_0.3 C_AN	ATTL5 0	N14.1 WXGA G	SO512 MBII5	N	N120 GB5.4 K	NSM8 X	ABT_ BRM4 318BG	FOX_ BRM_ 2.0	N
AS5053WXM i	AAP	Thailand	LX.AV 30J.05 6	AS5053WX Mi MCETH1 UMAC 1*1G/120/ BT/6L/5R/ CB_bg_0.3 C_AN	ATTL5 2	N14.1 WXGA G	SO1G BII6	N	N120 GB5.4 K	NSM8 X	ABT_ BRM4 318BG	FOX_ BRM_ 2.0	N
AS5051ANW XMi	EMEA	Middle East	LX.AV 30C.0 22	AS5051AN WXMi LINPUSAR 9 UMAC 1*512/60/ BT/6L/ 5R_bg_0.3 C_AN	ATMK 36	N14.1 WXGA	SO512 MBII5	N	N60G B5.4K	NSM8 X	ABT_ BRM4 318BG	FOX_ BRM_ 2.0	N
AS5051ANW XMi	EMEA	Middle East	LX.AV 30C.0 24	AS5051AN WXMi LINPUSAR 9 UMAC 1*512/60/ BT/6L/5R/ CB_bg_0.3 C_AN	ATMK 36	N14.1 WXGA G	SO512 MBII5	N	N60G B5.4K	NSM8 X	ABT_ BRM4 318BG	FOX_ BRM_ 2.0	N

Model	RO	Country	Acer Part no	Description	CPU	LCD	DIMM 1	DIMM 2	HDD 1 (GB)	ODD	Wireless LAN	Bluetooth	VOIP Phone
AS5051ANW XMi	EMEA	Middle East	LX.AV 30C.0 20	AS5051AN WXMi LINPUSAR 7 UMAC 1*512/60/ BT/6L/ 5R_bg_0.3 C_AN	ATMK 36	N14.1 WXGA	SO512 MBII5	N	N60G B5.4K	NSM8 X	ABT_ BRM4 318BG	FOX_ BRM_ 2.0	N
AS5051ANW XMi	EMEA	France	LX.AV 30C.0 21	AS5051AN WXMi LINPUSFR A UMAC 1*512/60/ 6L/ 5R_bg_0.3 C_AN	ATMK 36	N14.1 WXGA	SO512 MBII5	N	N60G B5.4K	NSM8 X	ABT_ BRM4 318BG	N	N
AS5051ANW XMi	EMEA	Russia	LX.AV 30C.0 23	AS5051AN WXMi LINPUSRU 5 UMAC 1*512/60/ 6L/ 5R_bg_0.3 C_AN	ATMK 36	N14.1 WXGA	SO512 MBII5	N	N60G B5.4K	NSM8 X	ABT_ BRM4 318BG	N	N
AS5051AWX Mi	EMEA	Middle East	LX.AV 305.04 4	AS5051AW XMi XPHAR8 UMAC 1*512/60/ BT/6L/5R/ CB_bg_0.3 C_AN	ATMK 36	N14.1 WXGA G	SO512 MBII5	N	N60G B5.4K	NSM8 X	ABT_ BRM4 318BG	FOX_ BRM_ 2.0	N
AS5051AWX Mi	EMEA	Eastern Europe	LX.AV 30J.05 7	AS5051AW XMi MCEPL7 UMAC 1*512/100/ BT/6L/ 5R_bg_VP _0.3C_AN	ATMK 36	N14.1 WXGA	SO512 MBII6	N	N100 GB5.4 K	NSM8 X	ABT_ BRM4 318BG	FOX_ BRM_ 2.0	BT VoIP PCMC IA
AS5051AWX Mi	EMEA	Russia	LX.AV 305.04 5	AS5051AW XMi XPHRU1 UMAC 1*512/100/ BT/6L/ 5R_bg_VP _0.3C_AN	ATMK 36	N14.1 WXGA	SO512 MBII6	N	N100 GB5.4 K	NSM8 X	ABT_ BRM4 318BG	FOX_ BRM_ 2.0	BT VoIP PCMC IA
AS5052WXM i	TWN	GCTWN	LX.AV 30J.05 8	AS5052WX Mi MCETC9 UMAC 1*512/120/ BT/6L/5R/ CB_bg_0.3 C_AN	ATTL5 0	N14.1 WXGA G	SO512 MBII5	N	N120 GB5.4 K	NSM8 X	ABT_ BRM4 318BG	FOX_ BRM_ 2.0	N
AS5052WXM i	TWN	GCTWN	LX.AV 305.04 6	AS5052WX Mi XPHTC1 UMAC 1*512/120/ BT/6L/5R/ CB_bg_0.3 C_AN	ATTL5 0	N14.1 WXGA G	SO512 MBII5	N	N120 GB5.4 K	NSM8 X	ABT_ ATH54 13BG	FOX_ BRM_ 2.0	N
AS5051AWX Mi	EMEA	Switzerland	LX.AV 30J.05 9	AS5051AW XMi MCESW8 UMAC 2*512/120/ BT/6L/5R/ CB_bg_0.3 C_AN	ATMK 36	N14.1 WXGA G	SO512 MBII5	SO512 MBII5	N120 GB5.4 K	NSM8 X	ABT_ BRM4 318BG	FOX_ BRM_ 2.0	N

Model	RO	Country	Acer Part no	Description	CPU	LCD	DIMM 1	DIMM 2	HDD 1 (GB)	ODD	Wireless LAN	Bluetooth	VOIP Phone
AS5051AWX Mi	EMEA	Switzerland	LX.AV 30J.060	AS5051AW XMi MCESW8 UMAC 2*512/120/6L/5R/CB_bg_0.3 C_AN	ATMK 36	N14.1 WXGA G	SO512 MBII5	SO512 MBII5	N120 GB5.4 K	NSM8 X	ABT_BRM4 318BG	N	N
AS5051AWX Mi	EMEA	Portugal	LX.AV 30J.061	AS5051AW XMi MCEPT6 UMAC 2*512/120/6L/5R_bg_0.3 C_AN	ATMK 36	N14.1 WXGA	SO512 MBII5	SO512 MBII5	N120 GB5.4 K	NSM8 X	ABT_BRM4 318BG	N	N
AS5051AWX Mi	EMEA	Spain	LX.AV 30J.062	AS5051AW XMi MCEESJ UMAC 2*512/120/6L/5R_bg_0.3 C_AN	ATMK 36	N14.1 WXGA	SO512 MBII5	SO512 MBII5	N120 GB5.4 K	NSM8 X	ABT_BRM4 318BG	N	N
AS5051AWX Mi	EMEA	Germany	LX.AV 30J.064	AS5051AW XMi MCEDEA UMAC 2*512/120/6L/5R_bg_0.3 C_AN	ATMK 36	N14.1 WXGA	SO512 MBII5	SO512 MBII5	N120 GB5.4 K	NSM8 X	ABT_BRM4 318BG	N	N
AS5051AWX Mi	EMEA	Germany	LX.AV 30J.065	AS5051AW XMi MCEDEB UMAC 2*512/120/6L/5R_bg_0.3 C_AN	ATMK 36	N14.1 WXGA	SO512 MBII5	SO512 MBII5	N120 GB5.4 K	NSM8 X	ABT_BRM4 318BG	N	N
AS5051AWX Mi	EMEA	Middle East	LX.AV 30J.070	AS5051AW XMi MCEAR1 UMAC 2*512/120/6L/5R_bg_0.3 C_AN	ATMK 36	N14.1 WXGA	SO512 MBII5	SO512 MBII5	N120 GB5.4 K	NSM8 X	ABT_BRM4 318BG	N	N
AS5051AWX Mi	EMEA	Middle East	LX.AV 30J.084	AS5051AW XMi MCEAR2 UMAC 2*512/120/6L/5R_bg_0.3 C_AN	ATMK 36	N14.1 WXGA	SO512 MBII5	SO512 MBII5	N120 GB5.4 K	NSM8 X	ABT_BRM4 318BG	N	N
AS5051AWX Mi	EMEA	Belgium	LX.AV 30J.066	AS5051AW XMi MCEBE6 UMAC 2*512/120/6L/5R_bg_0.3 C_AN	ATMK 36	N14.1 WXGA	SO512 MBII5	SO512 MBII5	N120 GB5.4 K	NSM8 X	ABT_BRM4 318BG	N	N
AS5051AWX Mi	EMEA	Eastern Europe	LX.AV 30J.079	AS5051AW XMi MCECS5 UMAC 2*512/120/6L/5R_bg_0.3 C_AN	ATMK 36	N14.1 WXGA	SO512 MBII5	SO512 MBII5	N120 GB5.4 K	NSM8 X	ABT_BRM4 318BG	N	N

Model	RO	Country	Acer Part no	Description	CPU	LCD	DIMM 1	DIMM 2	HDD 1 (GB)	ODD	Wireless LAN	Bluetooth	VOIP Phone
AS5051AWX Mi	EMEA	Holland	LX.AV 30J.069	AS5051AW XMi MCENL6 UMAC 2*512/120/6L/ 5R_bg_0.3 C_AN	ATMK 36	N14.1 WXGA	SO512 MBII5	SO512 MBII5	N120 GB5.4 K	NSM8 X	ABT_BRM4 318BG	N	N
AS5051AWX Mi	EMEA	Italy	LX.AV 30J.071	AS5051AW XMi MCEIT7 UMAC 2*512/120/6L/ 5R_bg_0.3 C_AN	ATMK 36	N14.1 WXGA	SO512 MBII5	SO512 MBII5	N120 GB5.4 K	NSM8 X	ABT_BRM4 318BG	N	N
AS5051AWX Mi	EMEA	Denmark	LX.AV 30J.074	AS5051AW XMi MCEDK6 UMAC 2*512/120/6L/ 5R_bg_0.3 C_AN	ATMK 36	N14.1 WXGA	SO512 MBII5	SO512 MBII5	N120 GB5.4 K	NSM8 X	ABT_BRM4 318BG	N	N
AS5051AWX Mi	EMEA	France	LX.AV 30J.063	AS5051AW XMi MCEFRF UMAC 2*512/120/6L/ 5R_bg_0.3 C_AN	ATMK 36	N14.1 WXGA	SO512 MBII5	SO512 MBII5	N120 GB5.4 K	NSM8 X	ABT_BRM4 318BG	N	N
AS5051AWX Mi	EMEA	Norway	LX.AV 30J.073	AS5051AW XMi MCENO5 UMAC 1*512/80/6L/ 5R_bg_0.3 C_AN	ATMK 36	N14.1 WXGA	SO512 MBII6	N	N80G B5.4K	NSM8 X	ABT_BRM4 318BG	N	N
AS5051AWX Mi	EMEA	Norway	LX.AV 30J.075	AS5051AW XMi MCENO5 UMAC 2*512/120/6L/ 5R_bg_0.3 C_AN	ATMK 36	N14.1 WXGA	SO512 MBII5	SO512 MBII5	N120 GB5.4 K	NSM8 X	ABT_BRM4 318BG	N	N
AS5051AWX Mi	EMEA	Russia	LX.AV 30J.080	AS5051AW XMi MCERU9 UMAC 2*512/120/6L/ 5R_bg_0.3 C_AN	ATMK 36	N14.1 WXGA	SO512 MBII5	SO512 MBII5	N120 GB5.4 K	NSM8 X	ABT_BRM4 318BG	N	N
AS5051AWX Mi	EMEA	Slovenia/Croatia	LX.AV 30J.085	AS5051AW XMi MCESI1 UMAC 2*512/120/6L/ 5R_bg_0.3 C_AN	ATMK 36	N14.1 WXGA	SO512 MBII5	SO512 MBII5	N120 GB5.4 K	NSM8 X	ABT_BRM4 318BG	N	N
AS5051AWX Mi	EMEA	Switzerland	LX.AV 30J.086	AS5051AW XMi MCESW8 UMAC 2*512/120/6L/ 5R_bg_0.3 C_AN	ATMK 36	N14.1 WXGA	SO512 MBII5	SO512 MBII5	N120 GB5.4 K	NSM8 X	ABT_BRM4 318BG	N	N

Model	RO	Country	Acer Part no	Description	CPU	LCD	DIMM 1	DIMM 2	HDD 1 (GB)	ODD	Wireless LAN	Bluetooth	VOIP Phone
AS5051AWX Mi	EMEA	Eastern Europe	LX.AV 30J.068	AS5051AW XMi MCEPL7 UMAC 2*512/120/6L/ 5R_bg_0.3 C_AN	ATMK 36	N14.1 WXGA	SO512 MBII5	SO512 MBII5	N120 GB5.4 K	NSM8 X	ABT_BRM4 318BG	N	N
AS5051AWX Mi	EMEA	Sweden/ Finland	LX.AV 30J.067	AS5051AW XMi MCESV5 UMAC 2*512/120/6L/ 5R_bg_0.3 C_AN	ATMK 36	N14.1 WXGA	SO512 MBII5	SO512 MBII5	N120 GB5.4 K	NSM8 X	ABT_BRM4 318BG	N	N
AS5051AWX Mi	EMEA	UK	LX.AV 30J.081	AS5051AW XMi MCEUUK1 1U UMAC 2*512/120/6L/ 5R_bg_0.3 C_AN	ATMK 36	N14.1 WXGA	SO512 MBII5	SO512 MBII5	N120 GB5.4 K	NSM8 X	ABT_BRM4 318BG	N	N
AS5051AWX Mi	EMEA	UK	LX.AV 30J.087	AS5051AW XMi MCEUK5 UMAC 2*512/120/6L/ 5R_bg_0.3 C_AN	ATMK 36	N14.1 WXGA	SO512 MBII5	SO512 MBII5	N120 GB5.4 K	NSM8 X	ABT_BRM4 318BG	N	N
AS5051AWX Mi	EMEA	Turkey	LX.AV 30J.072	AS5051AW XMi MCETR5 UMAC 2*512/120/6L/ 5R_bg_0.3 C_AN	ATMK 36	N14.1 WXGA	SO512 MBII5	SO512 MBII5	N120 GB5.4 K	NSM8 X	ABT_BRM4 318BG	N	N
AS5051AWX Mi	EMEA	Italy	LX.AV 30J.076	AS5051AW XMi MCEWIT11 W UMAC 2*512/120/6L/ 5R_bg_0.3 C_AN	ATMK 36	N14.1 WXGA	SO512 MBII5	SO512 MBII5	N120 GB5.4 K	NSM8 X	ABT_BRM4 318BG	N	N
AS5051AWX Mi	EMEA	UK	LX.AV 30J.088	AS5051AW XMi MCEUK6 UMAC 2*512/120/6L/ 5R_bg_0.3 C_AN	ATMK 36	N14.1 WXGA	SO512 MBII5	SO512 MBII5	N120 GB5.4 K	NSM8 X	ABT_BRM4 318BG	N	N
AS5051AWX Mi	EMEA	France	LX.AV 30J.077	AS5051AW XMi MCEWFR1 1W UMAC 2*512/120/6L/ 5R_bg_0.3 C_AN	ATMK 36	N14.1 WXGA	SO512 MBII5	SO512 MBII5	N120 GB5.4 K	NSM8 X	ABT_BRM4 318BG	N	N
AS5051AWX Mi	EMEA	Germany	LX.AV 30J.078	AS5051AW XMi MCEWDE1 1W UMAC 2*512/120/6L/ 5R_bg_0.3 C_AN	ATMK 36	N14.1 WXGA	SO512 MBII5	SO512 MBII5	N120 GB5.4 K	NSM8 X	ABT_BRM4 318BG	N	N

Model	RO	Country	Acer Part no	Description	CPU	LCD	DIMM 1	DIMM 2	HDD 1 (GB)	ODD	Wireless LAN	Bluetooth	VOIP Phone
AS5051AWX Mi	EMEA	Germany	LX.AV 305.057	AS5051AW XMi XPHDE7 UMAC 2*512/120/6L/ 5R_bg_0.3 C_AN	ATMK 36	N14.1 WXGA	SO512 MBII5	SO512 MBII5	N120 GB5.4 K	NSM8 X	ABT_BRM4 318BG	N	N
AS5051AWX Mi	EMEA	Middle East	LX.AV 305.061	AS5051AW XMi XPHAR1 UMAC 2*512/120/6L/ 5R_bg_0.3 C_AN	ATMK 36	N14.1 WXGA	SO512 MBII5	SO512 MBII5	N120 GB5.4 K	NSM8 X	ABT_BRM4 318BG	N	N
AS5051AWX Mi	EMEA	Denmark	LX.AV 305.047	AS5051AW XMi XPHDK1 UMAC 2*512/120/6L/ 5R_bg_0.3 C_AN	ATMK 36	N14.1 WXGA	SO512 MBII5	SO512 MBII5	N120 GB5.4 K	NSM8 X	ABT_BRM4 318BG	N	N
AS5051AWX Mi	EMEA	Belgium	LX.AV 305.056	AS5051AW XMi XPHBE1 UMAC 2*512/120/6L/ 5R_bg_0.3 C_AN	ATMK 36	N14.1 WXGA	SO512 MBII5	SO512 MBII5	N120 GB5.4 K	NSM8 X	ABT_BRM4 318BG	N	N
AS5051AWX Mi	EMEA	Eastern Europe	LX.AV 305.052	AS5051AW XMi XPHCS2 UMAC 2*512/120/6L/ 5R_bg_0.3 C_AN	ATMK 36	N14.1 WXGA	SO512 MBII5	SO512 MBII5	N120 GB5.4 K	NSM8 X	ABT_BRM4 318BG	N	N
AS5051AWX Mi	EMEA	UK	LX.AV 30J.083	AS5051AW XMi MCEWUK1 1W UMAC 2*512/120/6L/ 5R_bg_0.3 C_AN	ATMK 36	N14.1 WXGA	SO512 MBII5	SO512 MBII5	N120 GB5.4 K	NSM8 X	ABT_BRM4 318BG	N	N
AS5051AWX Mi	EMEA	UK	LX.AV 30J.082	AS5051AW XMi MCEWUK2 1W UMAC 2*512/120/6L/ 5R_bg_0.3 C_AN	ATMK 36	N14.1 WXGA	SO512 MBII5	SO512 MBII5	N120 GB5.4 K	NSM8 X	ABT_BRM4 318BG	N	N
AS5051AWX Mi	EMEA	Eastern Europe	LX.AV 305.051	AS5051AW XMi XPHHU6 UMAC 2*512/120/6L/ 5R_bg_0.3 C_AN	ATMK 36	N14.1 WXGA	SO512 MBII5	SO512 MBII5	N120 GB5.4 K	NSM8 X	ABT_BRM4 318BG	N	N
AS5051AWX Mi	EMEA	Spain	LX.AV 305.059	AS5051AW XMi XPHESA UMAC 2*512/120/6L/ 5R_bg_0.3 C_AN	ATMK 36	N14.1 WXGA	SO512 MBII5	SO512 MBII5	N120 GB5.4 K	NSM8 X	ABT_BRM4 318BG	N	N

Model	RO	Country	Acer Part no	Description	CPU	LCD	DIMM 1	DIMM 2	HDD 1 (GB)	ODD	Wireless LAN	Bluetooth	VOIP Phone
AS5051AWX Mi	EMEA	Greece	LX.AV 305.054	AS5051AW XMi XPHEL1 UMAC 2*512/120/6L/ 5R_bg_0.3 C_AN	ATMK 36	N14.1 WXGA	SO512 MBII5	SO512 MBII5	N120 GB5.4 K	NSM8 X	ABT_BRM4 318BG	N	N
AS5051AWX Mi	EMEA	Israel	LX.AV 305.069	AS5051AW XMi XPHIS1 UMAC 2*512/120/6L/ 5R_bg_0.3 C_AN	ATMK 36	N14.1 WXGA	SO512 MBII5	SO512 MBII5	N120 GB5.4 K	NSM8 X	ABT_BRM4 318BG	N	N
AS5051AWX Mi	EMEA	France	LX.AV 305.048	AS5051AW XMi XPHFRA UMAC 2*512/120/6L/ 5R_bg_0.3 C_AN	ATMK 36	N14.1 WXGA	SO512 MBII5	SO512 MBII5	N120 GB5.4 K	NSM8 X	ABT_BRM4 318BG	N	N
AS5051AWX Mi	EMEA	Italy	LX.AV 305.055	AS5051AW XMi XPHIT1 UMAC 2*512/120/6L/ 5R_bg_0.3 C_AN	ATMK 36	N14.1 WXGA	SO512 MBII5	SO512 MBII5	N120 GB5.4 K	NSM8 X	ABT_BRM4 318BG	N	N
AS5051AWX Mi	EMEA	Eastern Europe	LX.AV 305.053	AS5051AW XMi XPHPL6 UMAC 2*512/120/6L/ 5R_bg_0.3 C_AN	ATMK 36	N14.1 WXGA	SO512 MBII5	SO512 MBII5	N120 GB5.4 K	NSM8 X	ABT_BRM4 318BG	N	N
AS5051AWX Mi	EMEA	Holland	LX.AV 305.067	AS5051AW XMi XPHNL1 UMAC 2*512/120/6L/ 5R_bg_0.3 C_AN	ATMK 36	N14.1 WXGA	SO512 MBII5	SO512 MBII5	N120 GB5.4 K	NSM8 X	ABT_BRM4 318BG	N	N
AS5051AWX Mi	AAP	Malaysia	LX.AV 305.066	AS5051AW XMi XPHMA2 UMAC 1*512/80/6L/5R/ CB_bg_0.3 C_AN	ATMK 36	N14.1 WXGA G	SO512 MBII5	N	N80G B5.4K	NSM8 X	ABT_ATH54 13BG	N	N
AS5051AWX Mi	EMEA	Norway	LX.AV 305.058	AS5051AW XMi XPHNO1 UMAC 2*512/120/6L/ 5R_bg_0.3 C_AN	ATMK 36	N14.1 WXGA	SO512 MBII5	SO512 MBII5	N120 GB5.4 K	NSM8 X	ABT_BRM4 318BG	N	N
AS5051AWX Mi	EMEA	South Africa	LX.AV 305.062	AS5051AW XMi XPHSA1 UMAC 2*512/120/6L/ 5R_bg_0.3 C_AN	ATMK 36	N14.1 WXGA	SO512 MBII5	SO512 MBII5	N120 GB5.4 K	NSM8 X	ABT_BRM4 318BG	N	N

Model	RO	Country	Acer Part no	Description	CPU	LCD	DIMM 1	DIMM 2	HDD 1 (GB)	ODD	Wireless LAN	Bluetooth	VOIP Phone
AS5051AWX Mi	EMEA	Russia	LX.AV 305.049	AS5051AW XMi XPHRU2 UMAC 2*512/120/6L/ 5R_bg_0.3 C_AN	ATMK 36	N14.1 WXGA	SO512 MBII5	SO512 MBII5	N120 GB5.4 K	NSM8 X	ABT_BRM4 318BG	N	N
AS5051AWX Mi	EMEA	Sweden/ Finland	LX.AV 305.050	AS5051AW XMi XPHSV1 UMAC 2*512/120/6L/ 5R_bg_0.3 C_AN	ATMK 36	N14.1 WXGA	SO512 MBII5	SO512 MBII5	N120 GB5.4 K	NSM8 X	ABT_BRM4 318BG	N	N
AS5051AWX Mi	EMEA	Slovenia/ Croatia	LX.AV 305.063	AS5051AW XMi XPHSLO2 UMAC 2*512/120/6L/ 5R_bg_0.3 C_AN	ATMK 36	N14.1 WXGA	SO512 MBII5	SO512 MBII5	N120 GB5.4 K	NSM8 X	ABT_BRM4 318BG	N	N
AS5051AWX Mi	EMEA	Portugal	LX.AV 305.068	AS5051AW XMi XPHPT1 UMAC 2*512/120/6L/ 5R_bg_0.3 C_AN	ATMK 36	N14.1 WXGA	SO512 MBII5	SO512 MBII5	N120 GB5.4 K	NSM8 X	ABT_BRM4 318BG	N	N
AS5051AWX Mi	EMEA	Switzerland	LX.AV 305.064	AS5051AW XMi XPHSW5 UMAC 2*512/120/6L/ 5R_bg_0.3 C_AN	ATMK 36	N14.1 WXGA	SO512 MBII5	SO512 MBII5	N120 GB5.4 K	NSM8 X	ABT_BRM4 318BG	N	N
AS5051AWX Mi	EMEA	UK	LX.AV 305.065	AS5051AW XMi XPHUK1 UMAC 2*512/120/6L/ 5R_bg_0.3 C_AN	ATMK 36	N14.1 WXGA	SO512 MBII5	SO512 MBII5	N120 GB5.4 K	NSM8 X	ABT_BRM4 318BG	N	N
AS5051AWX Mi	EMEA	Turkey	LX.AV 305.070	AS5051AW XMi XPHTR1 UMAC 2*512/120/6L/ 5R_bg_0.3 C_AN	ATMK 36	N14.1 WXGA	SO512 MBII5	SO512 MBII5	N120 GB5.4 K	NSM8 X	ABT_BRM4 318BG	N	N
AS5051ANW XMi	EMEA	Turkey	LX.AV 30C.025	AS5051AN WXMi LINPUSTR 1 UMAC 1*512/60/6L/5R/ CB_bg_0.3 C_AN	ATMK 36	N14.1 WXGA G	SO512 MBII5	N	N60G B5.4K	NSM8 X	ABT_BRM4 318BG	N	N
AS5051AWX Mi	EMEA	Turkey	LX.AV 305.071	AS5051AW XMi XPHTR1 UMAC 1*512/60/6L/5R/ CB_bg_0.3 C_AN	ATMK 36	N14.1 WXGA G	SO512 MBII5	N	N60G B5.4K	NSM8 X	ABT_BRM4 318BG	N	N



Model	RO	Country	Acer Part no	Description	CPU	LCD	DIMM 1	DIMM 2	HDD 1 (GB)	ODD	Wireless LAN	Bluetooth	VOIP Phone
AS5052NWXMi	AAP	India	LX.AV30C.026	AS5052N WXM LINPUSIL1 UMAC 1*512/80/ BT/6L/5R/ CB_bg_0.3 C_AN	ATTL50	N14.1 WXGA G	SO512 MBII5	N	N80G B5.4K	NSM8 X	ABT_ ATH54 13BG	FOX_ BRM_ 2.0	N



## Test Compatible Components

---

This computer's compatibility is tested and verified by Acer's internal testing department. All of its system functions are tested under Windows® XP Home, Windows® XP Pro environment.

Refer to the following lists for components, adapter cards, and peripherals which have passed these tests. Regarding configuration, combination and test procedures, please refer to the Aspire 7730/7730G series Compatibility Test Report released by the Acer Mobile System Testing Department.

# Microsoft® Windows® Vista Environment Test

## PCMCIA LAN Card Test

Type	Device specification
LAN Card 16 bit	3Com Megahertz LAN PC Card_589E (Ethernet)
LAN Card 32 bit	FE575C-3Com 10/100 LAN CardBus-Fast Ethernet

## Express Card Test

Type	Device specification
1394 Express Card	AboCom Express Card 54 1394B 800Mbps
TV Tuner Express Card	AVerTV Hybrid Express Slim
Card Reader Express Card	Maxell Express card 34 5in1 adapter
GigaLAN Express Card	NETGEAR Gigabit PC card

## Display Port Test

Type	Device specification
External Monitor - CRT Monitor	<ul style="list-style-type: none"><li>• Δ OC 779S</li><li>• View Sonic PF775 17"</li><li>• Philip 109P</li><li>• Dell 21" Monitor</li></ul>
External Monitor - LCD Monitor	<ul style="list-style-type: none"><li>• View Sonic 1680*1050</li><li>• CMV CM-930D 17" LCD (1280*1024)</li><li>• ACER AL2423W LCD area with 1920*1200</li><li>• Toshiba TV 37HL869 LCD area with 1366*768</li></ul>
Projector	<ul style="list-style-type: none"><li>• BenQ FB8225(QSMC)</li><li>• Panasonic PT-LC80U</li></ul>
HDTV - HDMI	<ul style="list-style-type: none"><li>• Toshiba TV 37HL869 LCD area with 1366*768</li><li>• FlexScan HD2441W with 1920*1080</li></ul>

## USB Port Test

Type	Device specification
Keyboard	<ul style="list-style-type: none"><li>• NewMen KB-085 USB KEYBOARD</li><li>• WiNTEK USB Keyboard</li><li>• Logitech Cordless Mouse and Keyboard (USB, Wheel), Microsoft Wireless Optical Desktop (USB PS/2)</li></ul>
Mouse	<ul style="list-style-type: none"><li>• Logitech Wheel Mouse (Optical, USB PS/2)</li><li>• Huaerte mouse(USB)</li><li>• NEC Mouse(USB )</li><li>• YAHOO XEPER Optical Mouse(USB)</li><li>• Logitech (Optical)</li><li>• Microsoft IntelliMouse Explorer 3.0 USB and PS/2 Compatible (Optical) (QSMC)</li></ul>

Type	Device specification
Printer	<ul style="list-style-type: none"> <li>Epson Stylus C65 Printer</li> <li>HP deskjet 3535 Printer</li> </ul>
Scanner	Canon USB2.0 Scanner
Speaker	<ul style="list-style-type: none"> <li>SCLAR</li> <li>OZAKI USB 5.1CH-IN-2SPK Digital Sound - US206</li> </ul>
Joystick	<ul style="list-style-type: none"> <li>NAZAR GPC-V70</li> <li>Logitech Freedom 2.4CordlessJoystick</li> </ul>
Card Reader	<ul style="list-style-type: none"> <li>5 in 1</li> <li>HR8-U2M MS/MS-PRO/DUO</li> </ul>
HDD	FUJITSU USB2.0 HDD
DVD CD/RW	<ul style="list-style-type: none"> <li>YAMAHA CD-R/RW Drive</li> <li>MP5125A DVD+RW/+R</li> </ul>
Handy Drive	<ul style="list-style-type: none"> <li>NETAC 1G</li> <li>Transcend 2G</li> </ul>
FDD	<ul style="list-style-type: none"> <li>IBM USB2.0 Device</li> <li>Panasonic YD-8U10 USB1.0 Device</li> </ul>
HUB	<ul style="list-style-type: none"> <li>BELKIN USB1.1 SLIM HUB (QSMC)</li> <li>D-Link 4-Port USB 2.0 Hub</li> <li>Hi-Speed 4-Port USB 2.0 HUB (IOGEAR)</li> </ul>

## Access Point Test

Type	Device specification
Wireless LAN AP	<ul style="list-style-type: none"> <li>D-Link 665</li> <li>Guest</li> <li>001601B8DD1A-G</li> <li>Buffalo WZR2-G300N(n)</li> </ul>

## Bluetooth Test

Type	Device specification
Mouse	<ul style="list-style-type: none"> <li>ACER Bluetooth Mouse</li> <li>Darfon Bluetooth Mouse (Ferrari 1000)</li> </ul>

---

## Card Reader Test

Type	Device specification
MMC Card	<ul style="list-style-type: none"><li>Transcend 512MB MMC Card</li><li>Kingston 1G MMC Card</li></ul>
SD Card	<ul style="list-style-type: none"><li>Sandisk 2.0G SD Card</li><li>A-Data 2G SD Card</li><li>Turbo Series SDHC 16GB CLASS 6</li><li>Sandisk microSDHC 8G SD Card</li><li>Transcend 2G SD Card</li></ul>
MS Card	Sandisk 64MB MS Card (QSMC)
MS Pro Card	Sony 256MB MS Card (MS Pro)
MS Duo Adapter	Sandisk Memory Stick Duo Adaptor
Micro SD	Transcend MicroSD 2G
XD Card	<ul style="list-style-type: none"><li>OLYMPUS XD Picture Card 1G</li><li>OLYMPUS XD Picture Card 512MB</li><li>Fujifilm XD Picture Card 512M</li></ul>

## Audio Jacks Port Test

Type	Device specification
Speaker	Edifier Speaker
Head Phone	<ul style="list-style-type: none"><li>Jazz 369 Headphone</li><li>Philips Headphone</li><li>MO-J39 Headphone</li></ul>
SPDIF	Creative Inspire 5.1 digital 5600

## Port Replicator Test

Type	Device specification
Docking	Cable Docking

# Online Support Information

---

This section describes online technical support services available to help you repair your Acer Systems.

If you are a distributor, dealer, ASP or TPM, please refer your technical queries to your local Acer branch office. Acer Branch Offices and Regional Business Units may access our website. However some information sources will require a user i.d. and password. These can be obtained directly from Acer CSD Taiwan.

Acer's Website offers you convenient and valuable support resources whenever you need them.

In the Technical Information section you can download information on all of Acer's Notebook, Desktop and Server models including:

- Service guides for all models
- User's manuals
- Training materials
- Bios updates
- Software utilities
- Spare parts lists
- TABs (Technical Announcement Bulletin)

For these purposes, we have included an Acrobat File to facilitate the problem-free downloading of our technical material.

Also contained on this website are:

- Detailed information on Acer's International Traveler's Warranty (ITW)
- Returned material authorization procedures
- An overview of all the support services we offer, accompanied by a list of telephone, fax and email contacts for all your technical queries.

We are always looking for ways to optimize and improve our services, so if you have any suggestions or comments, please do not hesitate to communicate these to us.





**A**

AFLASH Utility 39

**B**

Battery Pack 46

BIOS

- package 22
- password control 22
- ROM size 21
- ROM type 21
- vendor 21
- Version 21

BIOS Supports protocol 22

BIOS Utility 27–39

- Advanced 30
- Boot 37
- Exit 38
- Navigating 27
- Onboard Device Configuration 33
- Power 35
- Save and Exit 38
- Security 32
- System Security 38

Bluetooth board 81

Board Layout

- Top View 155

brightness

- hotkeys 14

**C**

Camera Module 92

caps lock

- on indicator 10

Chipset POST Codes 145

Common Problems 128

computer

- on indicator 10

Core POST Codes 147

CPU 87

**D**

DIMM Module 50, 51

Display 4

display

- hotkeys 14

**E**

EasyTouch Failure 140

Euro 15

ExpressCard Module 83

External Module Disassembly

- Flowchart 45

**F**

Features 1

Fingerprint Reader Failure 141

Flash Utility 39

FPC Cable 94

FRU (Field Replaceable Unit) List 159

**H**

Hard Disk Drive1 Module 55

Hard Disk Drive2 Module 58

HDTV Switch Failure 142

Hibernation mode

- hotkey 14

Hot Keys 12

**I**

Indicators 10

Intermittent Problems 144

Internal Microphone Failure 134

Internal Speaker Failure 132

inverter board 91

**J**

Jumper and Connector Locations 155

- Top View 155

**K**

Keyboard 65

Keyboard Failure 131

**L**

---

- Launch Board 77
- LCD Bezel 90
- LCD Brackets 94
- LCD Failure 131
- LCD Module Disassembly
  - Flowchart 89
- LCD Panel 93
- lower covers 49

## M

- Main Unit Disassembly
  - Flowchart 62
- Mainboard 85
- media access
  - on indicator 10
- MediaTouch Button Failure 141
- Memory Check 128
- Model Definition 170
- Modem Board 65
- Modem Failure 139

## N

- No Display Issue 129
- Notebook Manager
  - hotkey 14
- num lock
  - on indicator 10

## O

- ODD Failure 136
- Online Support Information 197
- optical drive module 60

## P

- Panel 5
  - Bottom 9
  - left 5
- PC Card 10
- POST Codes
  - Chipset 145
  - Core 147
- Power On Failure 128

## S

- Speaker Module 79
- speakers
  - hotkey 14
- System
  - Block Diagram 4

## T

- Test Compatible Components 193
- Thermal Unit Failure 142
- Top 155
- Touch Pad
  - hotkey 14
- Touch Pad Bracket 75
- Touch Pad Failure 132
- Troubleshooting
  - Built-in KB Failure 131
  - EasyTouch Buttons 140
  - Fingerprint Reader 141
  - HDTV Switch 142
  - Internal Microphone 134
  - Internal Speakers 132
  - LCD Failure 131
  - MediTouch Buttons 141
  - Modem 139
  - No Display 129
  - ODD 136
  - Other Failures 143
  - Power On 128
  - Thermal Unit 142
  - Touch Pad 132
  - USB 139
  - WLAN 140

- Turbo RAM module 51
- TV Tuner Module 53

## U

- Undetermined Problems 144
- USB Failure (Rightside) 139
- utility
  - BIOS 27–39

## W

- Windows 2000 Environment Test 194
- Wireless Function Failure 140
- WLAN Board 54